

GN 139.5

with Integrated Safety Switch

GN 139.6

without Switch

Hinges

Stainless Steel



JWWINCO
A Ganter Company

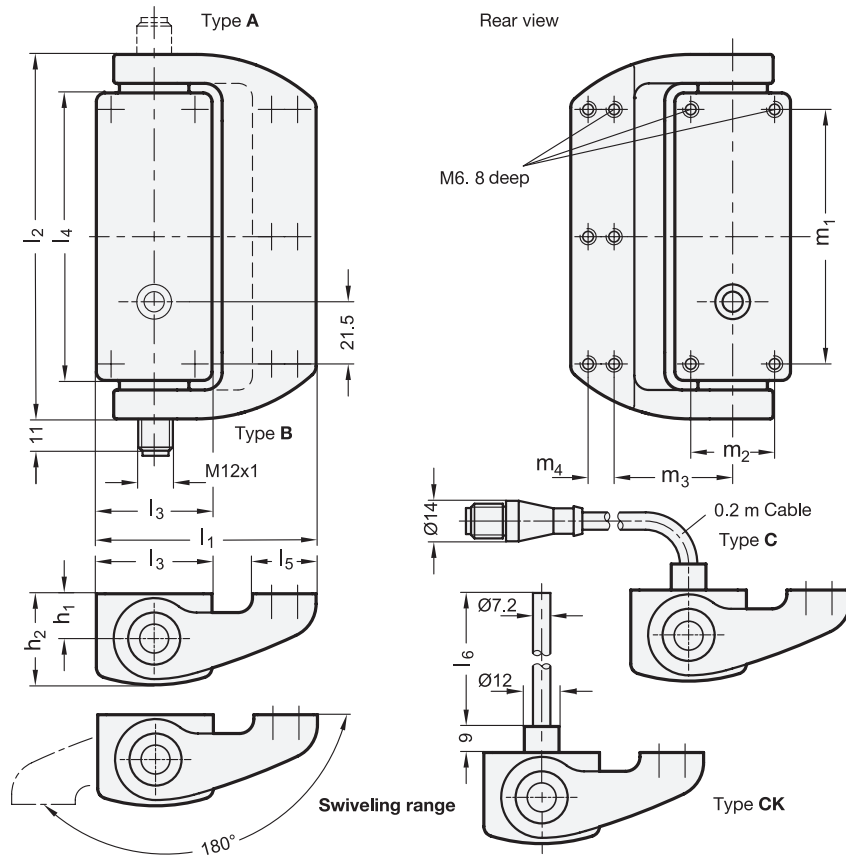

SS Stainless Steel

3 Type

- A Connector plug at the top
- B Connector plug at the bottom
- C Connector plug at the backside (with 0.2 m cable)
- CK Cable at the backside

Metric table

1	2					4							
l_1	l_2	l_3	l_4	l_5	l_6	Cable length in meters	h_1	h_2	m_1	m_2	m_3	m_4	Dimensions in: millimeters - inches
76	126	40	99.4	22	2	5	15.5	31.5	88	29	41	9	
2.99	4.96	1.57	3.91	0.87			0.61	1.24	3.46	1.14	1.61	0.35	

Specification

- Body
Stainless steel precision casting AISI 316L
Polished, $R_a < 0.8 \mu\text{m}$
- Pin
Stainless steel AISI 316L
- *Stainless Steel Characteristics* → page 2143
- **RoHS compliant**

Accessory

- Cables with connector coupling → page 1436
8-pole, 5 or 10 meters long:
 - GN 330-M12x1-8-G-5
 - GN 330-M12x1-8-G-10

On request

- Hinges with operating angle $> 0^\circ$
- Hinges with other contact loadings

Information

GN 139.5 hinges with integrated safety switch are designed for monitoring doors and covers of machines and in manufacturing plants. Opening the door will activate the switch contacts which, in turn, will then e.g. interrupt a protective circuit via break contact (NC) and at the same time signal the door opening by closing a normally open contact element (NO). The contact blocks are fitted with positive opening slow-action contacts, i.e. they will definitely be separated when activated and have no hysteresis. The angle at which the switching points are reached are adjustable.

Together with the integrated contact blocks, the hinges are a compact, easy to mount unit with an attractive design. The mounting from the back make the hinge more tamper-proof.

The compact construction combines safety with an attractive design. The hinges are tamper-proof because of the covered mounting from the backside.

GN 139.6 hinges without switch are designed to be used in conjunction with GN 139.5 hinges with integrated safety switch, in applications with larger doors or gates where several hinges are required.

How to order (With integrated safety switch)



1 2 3 4
GN 139.5-76-126-CK-5

- 1 Width l_1
- 2 Length l_2
- 3 Type
- 4 Cable length l_6

How to order (Without switch)

1 2
GN 139.6-76-126

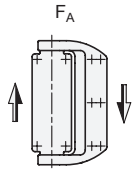
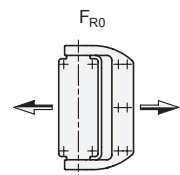
- 1 Width l_1
- 2 Length l_2

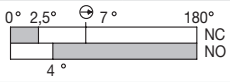
Mechanical features				
Maximum load Information with safety factor	Load direction			
Examples of calculation → see operating instruction	F max.	2000 N 449.62 lbf	2000 N 449.62 lbf	2000 N 449.62 lbf
Assembly	From the backside, 10 x thread M6, 8 mm deep			
Recommended torque	10 Nm (Screws M6)			
Protection class	IP67 / IP69K (Mind the cable conduit!)	acc. to EN 60529		
Switching principle, contact opening	Slow-action contacts, force-fitted, with positive opening	acc. to IEC 60947-5-1		
Contact material	Silver alloy			
Operating travel diagram (scheme)	The switching points are adjustable up to 2° in direction of 0°. → see operating instruction			
Maximum operating frequency	600 operating cycles / hour	acc. to IEC 60947-5-1,		
Mechanical life cycle	10 ⁶ operating cycles	one operating cycle includes one opening and one closing action		
Actuating speed	min. 2° / second, max. 90° / second			

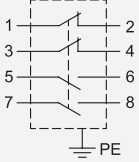
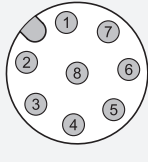
Electrical features / Safety features		
Utilization category	AC 15: 24 V AC / 2A / DC 13: 24 V DC / 2A (connector plug) AC 15: 250 V AC / 3A / DC 13: 250 V DC / 0.3 A (cable)	acc. to EN 60947-5-1
Contact, termination 8-pole connector M12 or 9 wire cable with 2 m or 5 m length		
Pin and cable assignment	1 - black 3 - red 5 - brown 7 - purple PE - yellow-green (only type CK)	2 - black-white 4 - red-white 6 - blue 8 - purple-white
Type of cable	9x0.34 mm ² , PVC H05VV-F, black	acc. to IEC 60332-1
Short-circuit current	1000 A	acc. to EN 60947-5-1
Rated insulation voltage	30 V AC / 36 V DC (connector plug) / 250 V AC (cable)	
Short-circuit protection	2 A, 500 V, Type gG (connector plug) / 3 A, 500 V, Type gG (cable)	
Ambient temperature	-13 °F up to +176 °F (- 25 °C up to + 80 °C)	
Degree of pollution, external	3	acc. to EN 60947-5-1
Safety parameters	B10: 1 000 000, B10 d: 5 000 000, B10 / B10 d: 20%	acc. to EN ISO 13849-1

Approvals, conformities, applicability		
Low-voltage switchgear and control-gear CE declaration EAC- and UL-certified	  	EN 60947-1/2007 EN 60947-1-5 : 2004 + A1/2009
Safety applications	until SIL 3 / PL e	acc. to EN ISO 13849-1

Other important details and hints are given in the operating instruction for GN 139.5 hinges which are included with every hinge and they are also available as PDF downloads from "www.jwwinco.com" under "Service".

The hinges with integrated safety switch must be mounted and commissioned by qualified technical personnel in compliance with the details given in the operating instructions and with the national / international rules and regulations along with the applicable standards. JW Winco will assume no statutory liability for missing or incorrect information and for any consequences arising therefrom.

3.1
3.2
3.3
3.4
3.5
3.6
3.7
3.8
3.9
3.10

