

# NSR02L30

## Schottky Barrier Diode

These Schottky barrier diodes are optimized for low forward voltage drop and low leakage current. The DSN2 (Dual Silicon No-lead) package is a chip level package using solderable metal contacts under the package similar to DFN style packages. The DSN2 style package enables 100% utilization of the package area for active silicon, offering a significant performance per board area advantage compared to products in plastic molded packages. The low thermal resistance enables designers to meet the challenging task of achieving higher efficiency and meeting reduced space requirements.

### Features

- Very Low Forward Voltage Drop – 400 mV @ 10 mA
- Low Reverse Current – 0.20  $\mu$ A @ 10 V VR
- 200 mA of Continuous Forward Current
- Power Dissipation of 312 mW with Minimum Trace
- ESD Rating – Human Body Model: Class 3B  
– Machine Model: Class C
- Very High Switching Speed
- Low Capacitance – CT = 7 pF
- This is a Halide-Free Device
- This is a Pb-Free Device

### Typical Applications

- LCD and Keypad Backlighting
- Camera Photo Flash
- Buck and Boost dc-dc Converters
- Reverse Voltage and Current Protection
- Clamping & Protection

### Markets

- Mobile Handsets
- MP3 Players
- Digital Camera and Camcorders
- Notebook PCs & PDAs
- GPS

### MAXIMUM RATINGS

Rating	Symbol	Value	Unit
Reverse Voltage	$V_R$	30	V
Forward Current (DC)	$I_F$	200	mA
Forward Surge Current (60 Hz @ 1 cycle)	$I_{FSM}$	4.0	A
ESD Rating: Human Body Model Machine Model	ESD	>8.0 >400	kV V

Stresses exceeding those listed in the Maximum Ratings table may damage the device. If any of these limits are exceeded, device functionality should not be assumed, damage may occur and reliability may be affected.



ON Semiconductor®

[www.onsemi.com](http://www.onsemi.com)

## 30 V SCHOTTKY BARRIER DIODE



DSN2  
(0201)  
CASE 152AA

### MARKING DIAGRAMS

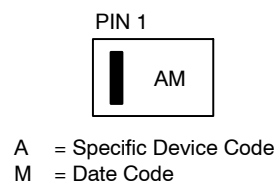
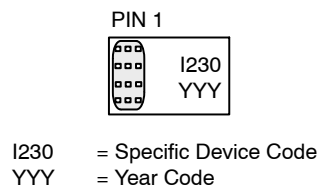

### ORDERING INFORMATION

Device	Package	Shipping†
NSR02L30NXT5G	DSN2 (Pb-Free)	5000 / Tape & Reel

†For information on tape and reel specifications, including part orientation and tape sizes, please refer to our Tape and Reel Packaging Specifications Brochure, BRD8011/D.

# NSR02L30

## THERMAL CHARACTERISTICS

Characteristic	Symbol	Min	Typ	Max	Unit
Thermal Resistance Junction-to-Ambient (Note 1) Total Power Dissipation @ $T_A = 25^\circ\text{C}$	$R_{\theta JA}$ $P_D$			400 312	$^\circ\text{C}/\text{W}$ mW
Thermal Resistance Junction-to-Ambient (Note 2) Total Power Dissipation @ $T_A = 25^\circ\text{C}$	$R_{\theta JA}$ $P_D$			170 735	$^\circ\text{C}/\text{W}$ mW
Storage Temperature Range	$T_{stg}$			-40 to +125	$^\circ\text{C}$
Junction Temperature	$T_J$			+150	$^\circ\text{C}$

1. Mounted onto a 4 in square FR-4 board 10 mm sq. 1 oz. Cu 0.06" thick single sided. Operating to steady state.
2. Mounted onto a 4 in square FR-4 board 1 in sq. 1 oz. Cu 0.06" thick single sided. Operating to steady state.

## ELECTRICAL CHARACTERISTICS ( $T_A = 25^\circ\text{C}$ unless otherwise noted)

Characteristic	Symbol	Min	Typ	Max	Unit
Reverse Leakage ( $V_R = 10\text{ V}$ ) ( $V_R = 30\text{ V}$ )	$I_R$			0.2 3.0	$\mu\text{A}$
Forward Voltage ( $I_F = 10\text{ mA}$ ) ( $I_F = 200\text{ mA}$ )	$V_F$			0.40 0.58	V
Total Capacitance ( $V_R = 5.0\text{ V}$ , $f = 1\text{ MHz}$ )	CT		7.0		pF

# NSR02L30

## TYPICAL CHARACTERISTICS

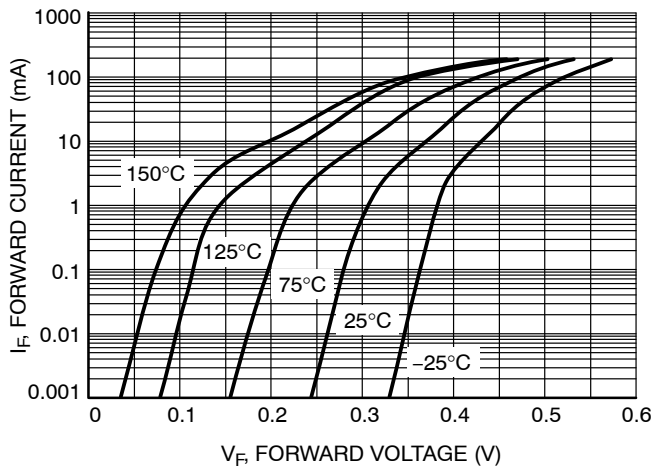

Figure 1. Forward Voltage

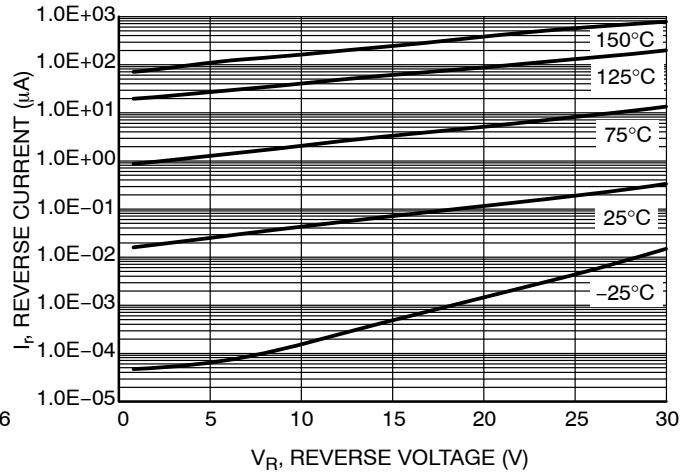

Figure 2. Leakage Current

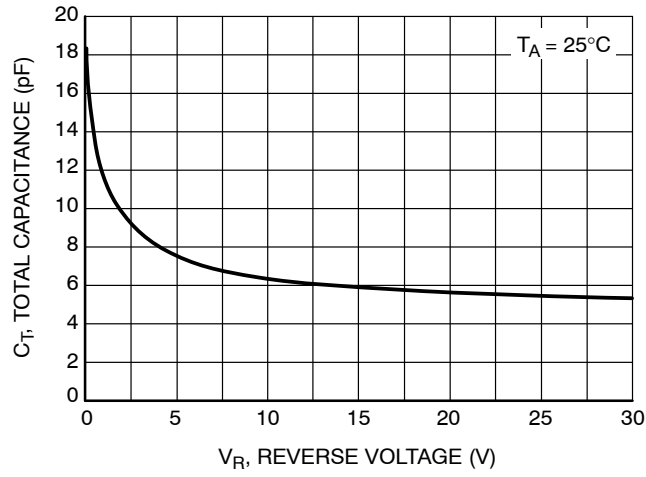

Figure 3. Total Capacitance



**DSN2, 0.6x0.3, 0.4P, (0201)**  
**CASE 152AA**  
**ISSUE B**

  
**SCALE 8:1**

**DATE 30 APR 2017**

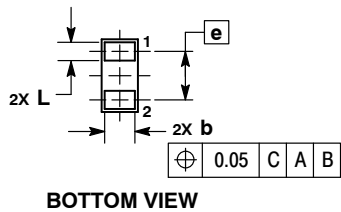
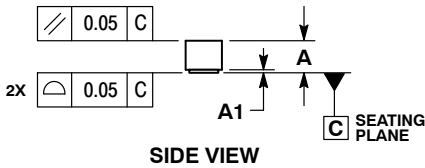
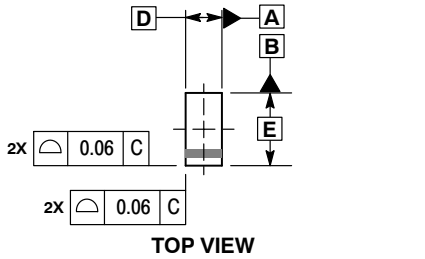

**MOUNTING FOOTPRINT\***

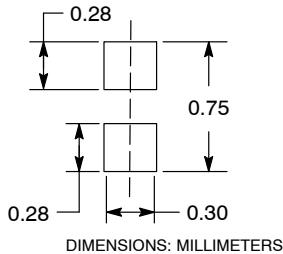

See Application Note AND8398/D for more mounting details

\*For additional information on our Pb-Free strategy and soldering details, please download the ON Semiconductor Soldering and Mounting Techniques Reference Manual, SOLDERRM/D.

- NOTES:  
 1. DIMENSIONING AND TOLERANCING PER ASME Y14.5M, 1994.  
 2. CONTROLLING DIMENSION: MILLIMETERS.

MILLIMETERS		
DIM	MIN	MAX
A	0.24	0.30
A1	0.00	0.01
b	0.20	0.22
D	0.30	BSC
E	0.60	BSC
e	0.40	BSC
L	0.10	0.12

**GENERIC MARKING DIAGRAM1\***

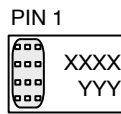

**GENERIC MARKING DIAGRAM2\***

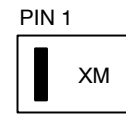

XXXX = Specific Device Code    X = Specific Device Code  
 YYY = Year Code                    M = Date Code

\*This information is generic. Please refer to device data sheet for actual part marking. Pb-Free indicator, "G", may or not be present. Some products may not follow the Generic Marking.

**CATHODE BAND MONTH CODING**

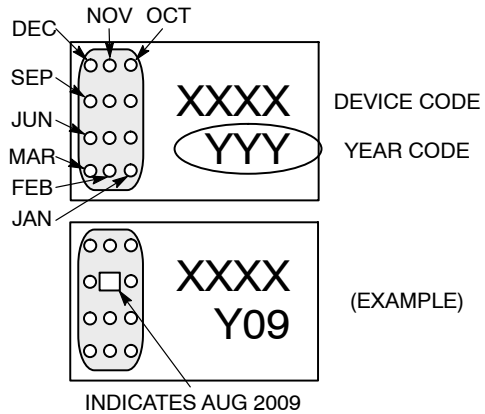

<b>DOCUMENT NUMBER:</b>	<b>98AON39897E</b>	Electronic versions are uncontrolled except when accessed directly from the Document Repository. Printed versions are uncontrolled except when stamped "CONTROLLED COPY" in red.
<b>DESCRIPTION:</b>	<b>DSN2, 0.6X0.3, 0.4P, (0201)</b>	<b>PAGE 1 OF 1</b>

ON Semiconductor and  are trademarks of Semiconductor Components Industries, LLC dba ON Semiconductor or its subsidiaries in the United States and/or other countries. ON Semiconductor reserves the right to make changes without further notice to any products herein. ON Semiconductor makes no warranty, representation or guarantee regarding the suitability of its products for any particular purpose, nor does ON Semiconductor assume any liability arising out of the application or use of any product or circuit, and specifically disclaims any and all liability, including without limitation special, consequential or incidental damages. ON Semiconductor does not convey any license under its patent rights nor the rights of others.

**onsemi**, **Onsemi**, and other names, marks, and brands are registered and/or common law trademarks of Semiconductor Components Industries, LLC dba "**onsemi**" or its affiliates and/or subsidiaries in the United States and/or other countries. **onsemi** owns the rights to a number of patents, trademarks, copyrights, trade secrets, and other intellectual property. A listing of **onsemi**'s product/patent coverage may be accessed at [www.onsemi.com/site/pdf/Patent-Marking.pdf](http://www.onsemi.com/site/pdf/Patent-Marking.pdf). **onsemi** reserves the right to make changes at any time to any products or information herein, without notice. The information herein is provided "as-is" and **onsemi** makes no warranty, representation or guarantee regarding the accuracy of the information, product features, availability, functionality, or suitability of its products for any particular purpose, nor does **onsemi** assume any liability arising out of the application or use of any product or circuit, and specifically disclaims any and all liability, including without limitation special, consequential or incidental damages. Buyer is responsible for its products and applications using **onsemi** products, including compliance with all laws, regulations and safety requirements or standards, regardless of any support or applications information provided by **onsemi**. "Typical" parameters which may be provided in **onsemi** data sheets and/or specifications can and do vary in different applications and actual performance may vary over time. All operating parameters, including "Typicals" must be validated for each customer application by customer's technical experts. **onsemi** does not convey any license under any of its intellectual property rights nor the rights of others. **onsemi** products are not designed, intended, or authorized for use as a critical component in life support systems or any FDA Class 3 medical devices or medical devices with a same or similar classification in a foreign jurisdiction or any devices intended for implantation in the human body. Should Buyer purchase or use **onsemi** products for any such unintended or unauthorized application, Buyer shall indemnify and hold **onsemi** and its officers, employees, subsidiaries, affiliates, and distributors harmless against all claims, costs, damages, and expenses, and reasonable attorney fees arising out of, directly or indirectly, any claim of personal injury or death associated with such unintended or unauthorized use, even if such claim alleges that **onsemi** was negligent regarding the design or manufacture of the part. **onsemi** is an Equal Opportunity/Affirmative Action Employer. This literature is subject to all applicable copyright laws and is not for resale in any manner.

## PUBLICATION ORDERING INFORMATION

### LITERATURE FULFILLMENT:

Email Requests to: [orderlit@onsemi.com](mailto:orderlit@onsemi.com)

**onsemi Website:** [www.onsemi.com](http://www.onsemi.com)

### TECHNICAL SUPPORT

**North American Technical Support:**  
Voice Mail: 1 800-282-9855 Toll Free USA/Canada  
Phone: 011 421 33 790 2910

**Europe, Middle East and Africa Technical Support:**

Phone: 00421 33 790 2910

For additional information, please contact your local Sales Representative