

# NTS1045MFS, NRVTS1045MFS

## Exceptionally Low Forward Voltage Trench-based Schottky Rectifier

### Features

- Fine Lithography Trench-based Schottky Technology for Very Low Forward Voltage and Low Leakage
- Fast Switching with Exceptional Temperature Stability
- Low Power Loss and Lower Operating Temperature
- Higher Efficiency for Achieving Regulatory Compliance
- Low Thermal Resistance
- High Surge Capability
- NRV Prefix for Automotive and Other Applications Requiring Unique Site and Control Change Requirements; AEC-Q101 Qualified and PPAP Capable
- These are Pb-Free and Halide-Free Devices

### Typical Applications

- Switching Power Supplies including Wireless, Smartphone and Notebook Adapters
- High Frequency and DC-DC Converters
- Freewheeling and OR-ing diodes
- Reverse Battery Protection
- Instrumentation

### Mechanical Characteristics:

- Case: Epoxy, Molded
- Epoxy Meets Flammability Rating UL 94-0 @ 0.125 in.
- Lead Finish: 100% Matte Sn (Tin)
- Lead and Mounting Surface Temperature for Soldering Purposes: 260°C Max. for 10 Seconds
- Device Meets MSL 1 Requirements



ON Semiconductor®

<http://onsemi.com>

**SCHOTTKY BARRIER  
RECTIFIERS  
10 AMPERES  
45 VOLTS**

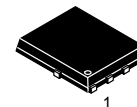

SO-8 FLAT LEAD  
CASE 488AA  
STYLE 2

### MARKING DIAGRAM

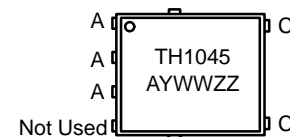

TH1045 = Specific Device Code  
A = Assembly Location  
Y = Year  
W = Work Week  
ZZ = Lot Traceability

### ORDERING INFORMATION

| Device          | Package              | Shipping†             |
|-----------------|----------------------|-----------------------|
| NTS1045MFST1G   | SO-8 FL<br>(Pb-Free) | 1500 /<br>Tape & Reel |
| NTS1045MFST3G   | SO-8 FL<br>(Pb-Free) | 5000 /<br>Tape & Reel |
| NRVTS1045MFST1G | SO-8 FL<br>(Pb-Free) | 1500 /<br>Tape & Reel |
| NRVTS1045MFST3G | SO-8 FL<br>(Pb-Free) | 5000 /<br>Tape & Reel |

†For information on tape and reel specifications, including part orientation and tape sizes, please refer to our Tape and Reel Packaging Specification Brochure, BRD8011/D.

# NTS1045MFS, NRVTS1045MFS

## MAXIMUM RATINGS

| Rating  | Symbol                          | Value       | Unit             |
|---|---------------------------------|-------------|------------------|
| Peak Repetitive Reverse Voltage<br>Working Peak Reverse Voltage<br>DC Blocking Voltage                      | $V_{RRM}$<br>$V_{RWM}$<br>$V_R$ | 45          | V                |
| Average Rectified Forward Current<br>(Rated $V_R$ , $T_C = 166^\circ\text{C}$ )                             | $I_{F(AV)}$                     | 10          | A                |
| Peak Repetitive Forward Current,<br>(Rated $V_R$ , Square Wave, 20 kHz, $T_C = 162^\circ\text{C}$ )         | $I_{FRM}$                       | 20          | A                |
| Non-Repetitive Peak Surge Current<br>(Surge Applied at Rated Load Conditions Halfwave, Single Phase, 60 Hz) | $I_{FSM}$                       | 210         | A                |
| Storage Temperature Range   | $T_{stg}$                       | -65 to +150 | $^\circ\text{C}$ |
| Operating Junction Temperature  | $T_J$                           | -55 to +150 | $^\circ\text{C}$ |
| Unclamped Inductive Switching Energy (10 mH Inductor, Non-repetitive)                                       | $E_{AS}$                        | 100         | mJ               |
| ESD Rating (Human Body Model)   |                                 | 3B          |                  |
| ESD Rating (Machine Model)  |                                 | M4          |                  |

Stresses exceeding those listed in the Maximum Ratings table may damage the device. If any of these limits are exceeded, device functionality should not be assumed, damage may occur and reliability may be affected.

## THERMAL CHARACTERISTICS

| Characteristic  | Symbol          | Typ | Max | Unit               |
|---|-----------------|-----|-----|--------------------|
| Thermal Resistance, Junction-to-Case, Steady State<br>(Assumes 600 mm <sup>2</sup> 1 oz. copper bond pad, on a FR4 board) | $R_{\theta JC}$ | -   | 2.0 | $^\circ\text{C/W}$ |

## ELECTRICAL CHARACTERISTICS

|  |       |                                  |                            |                     |
|--|-------|----------------------------------|----------------------------|---------------------|
| Instantaneous Forward Voltage (Note 1)<br>( $i_F = 5.0$ Amps, $T_J = 25^\circ\text{C}$ )<br>( $i_F = 10$ Amps, $T_J = 25^\circ\text{C}$ )<br><br>( $i_F = 5.0$ Amps, $T_J = 125^\circ\text{C}$ )<br>( $i_F = 10$ Amps, $T_J = 125^\circ\text{C}$ ) | $V_F$ | 0.42<br>0.48<br><br>0.34<br>0.41 | -<br>0.57<br><br>-<br>0.51 | V                   |
| Reverse Current (Note 1)<br>(Rated dc Voltage, $T_J = 25^\circ\text{C}$ )<br>(Rated dc Voltage, $T_J = 125^\circ\text{C}$ )  | $i_R$ | 20<br>7.0                        | 120<br>45                  | $\mu\text{A}$<br>mA |
| Diode Capacitance<br>(Rated dc Voltage, $T_J = 25^\circ\text{C}$ , $f = 1$ MHz)  | $C_d$ | 300                              |                            | pF                  |

Product parametric performance is indicated in the Electrical Characteristics for the listed test conditions, unless otherwise noted. Product performance may not be indicated by the Electrical Characteristics if operated under different conditions.

1. Pulse Test: Pulse Width = 300  $\mu\text{s}$ , Duty Cycle  $\leq 2.0\%$ .

TYPICAL CHARACTERISTICS

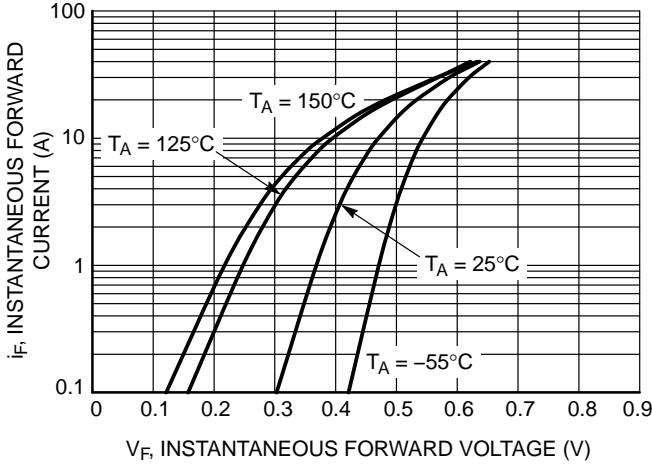

Figure 1. Typical Instantaneous Forward Characteristics

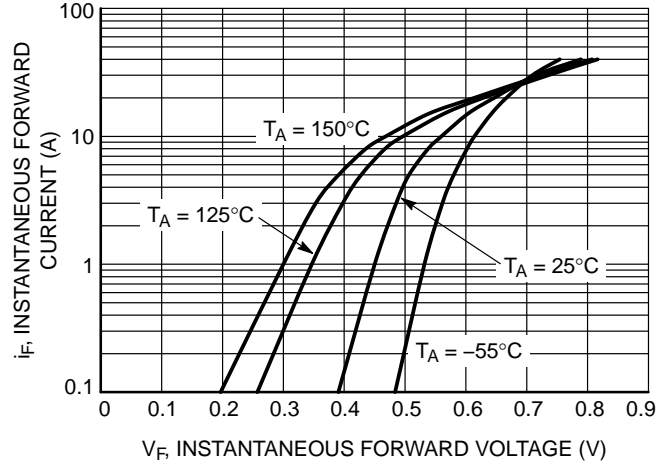

Figure 2. Maximum Instantaneous Forward Characteristics

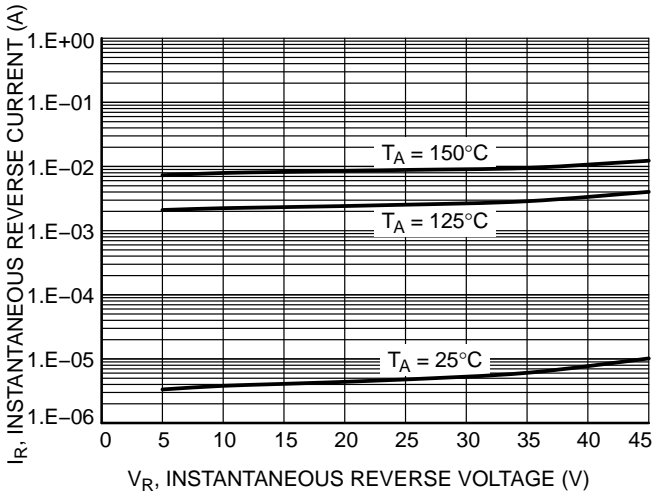

Figure 3. Typical Reverse Characteristics

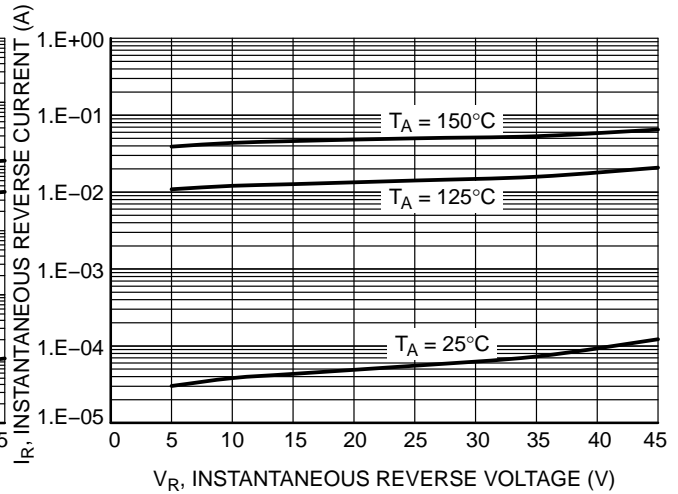

Figure 4. Maximum Reverse Characteristics

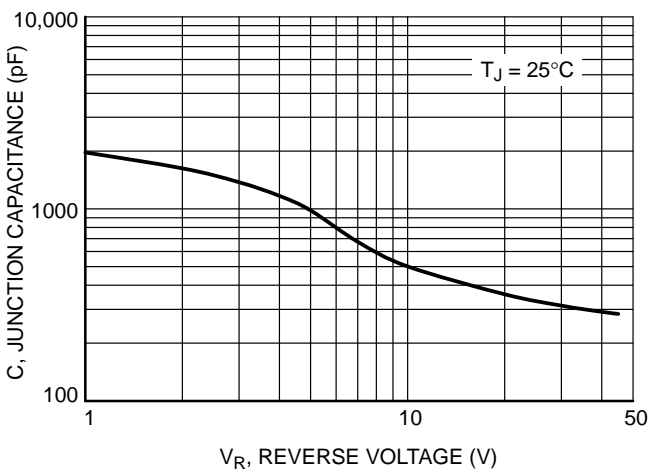

Figure 5. Typical Junction Capacitance

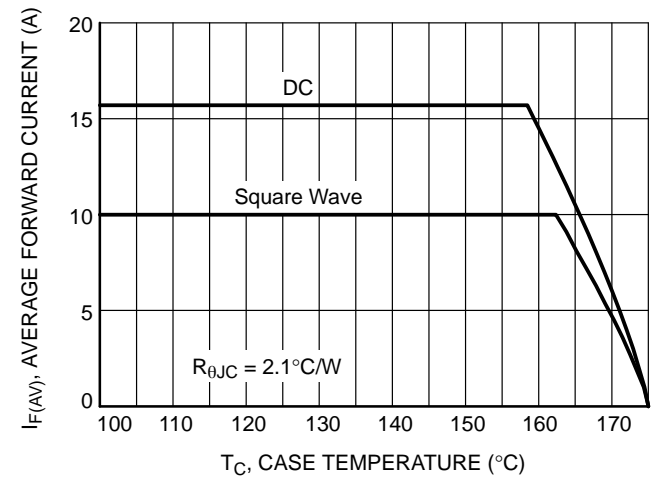

Figure 6. Current Derating

# NTS1045MFS, NRVTS1045MFS

## TYPICAL CHARACTERISTICS

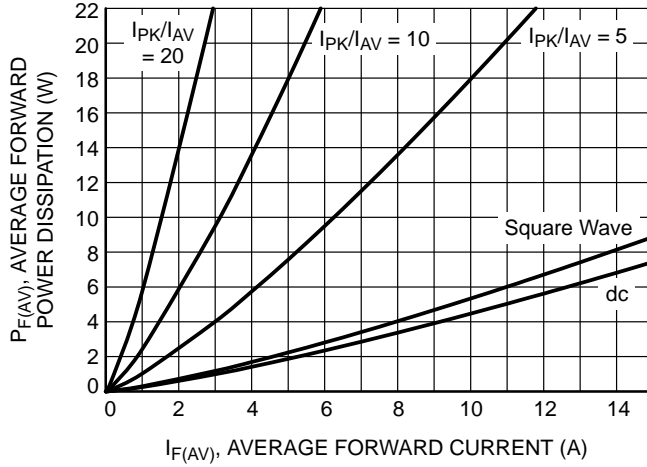

Figure 7. Forward Power Dissipation

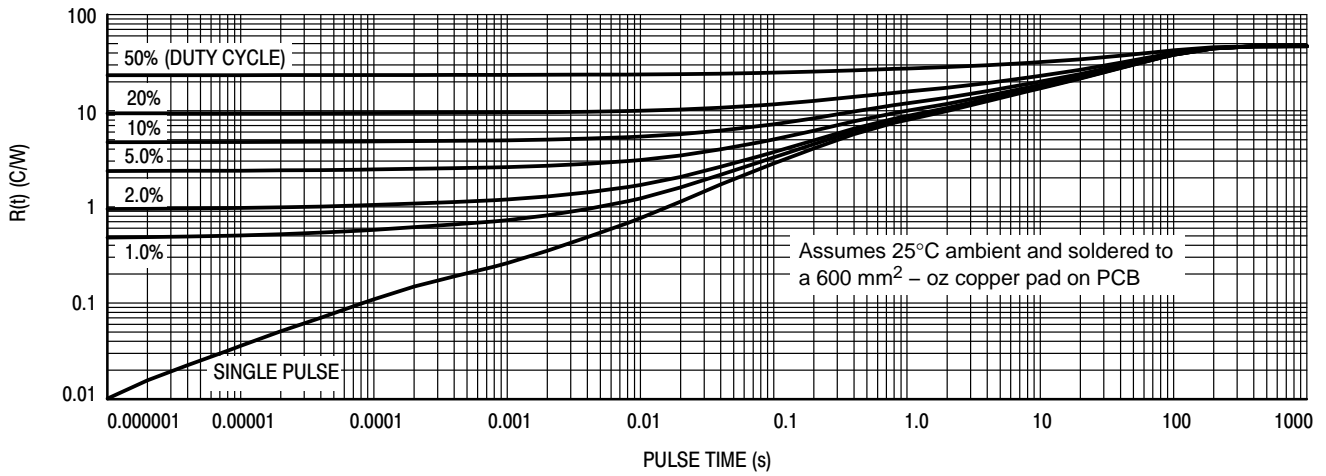

Figure 8. Typical Thermal Characteristics

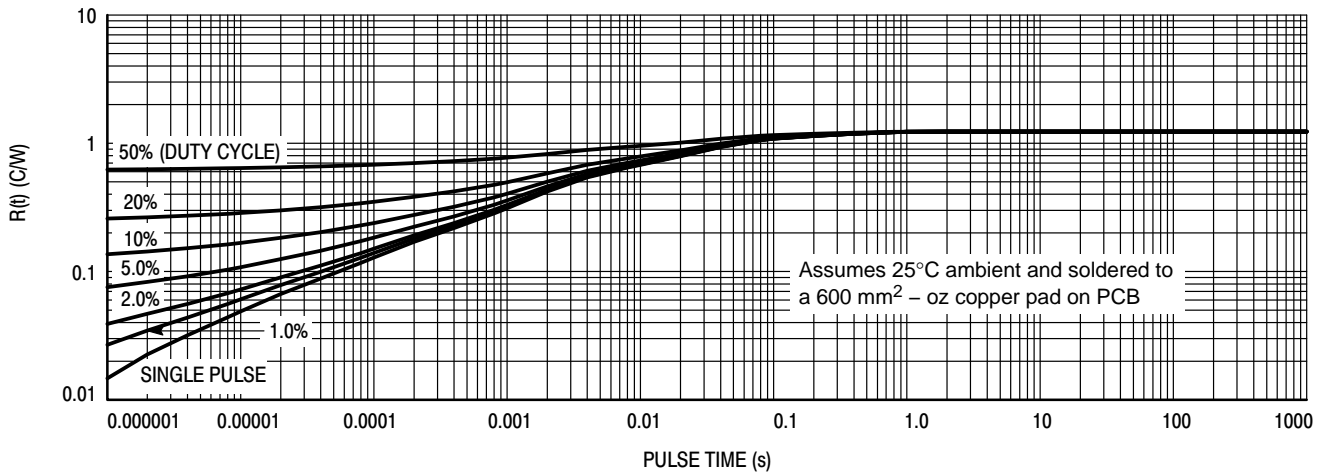

Figure 9. Typical Transient Thermal Response Characteristics, Junction-to-Case

# MECHANICAL CASE OUTLINE

## PACKAGE DIMENSIONS



1  
SCALE 2:1

DFN5 5x6, 1.27P  
(SO-8FL)  
CASE 488AA  
ISSUE N

DATE 25 JUN 2018



NOTES:

1. DIMENSIONING AND TOLERANCING PER ASME Y14.5M, 1994.
2. CONTROLLING DIMENSION: MILLIMETER.
3. DIMENSION D1 AND E1 DO NOT INCLUDE MOLD FLASH PROTRUSIONS OR GATE BURRS.

| DIM | MILLIMETERS |       |      |
|-----|-------------|-------|------|
|     | MIN         | NOM   | MAX  |
| A   | 0.90        | 1.00  | 1.10 |
| A1  | 0.00        | ---   | 0.05 |
| b   | 0.33        | 0.41  | 0.51 |
| c   | 0.23        | 0.28  | 0.33 |
| D   | 5.00        | 5.15  | 5.30 |
| D1  | 4.70        | 4.90  | 5.10 |
| D2  | 3.80        | 4.00  | 4.20 |
| E   | 6.00        | 6.15  | 6.30 |
| E1  | 5.70        | 5.90  | 6.10 |
| E2  | 3.45        | 3.65  | 3.85 |
| e   | 1.27 BSC    |       |      |
| G   | 0.51        | 0.575 | 0.71 |
| K   | 1.20        | 1.35  | 1.50 |
| L   | 0.51        | 0.575 | 0.71 |
| L1  | 0.125 REF   |       |      |
| M   | 3.00        | 3.40  | 3.80 |
| θ   | 0°          | ---   | 12°  |

### GENERIC MARKING DIAGRAM\*



- XXXXXX = Specific Device Code
- A = Assembly Location
- Y = Year
- W = Work Week
- ZZ = Lot Traceability

\*This information is generic. Please refer to device data sheet for actual part marking. Pb-Free indicator, "G" or microdot "•", may or may not be present. Some products may not follow the Generic Marking.

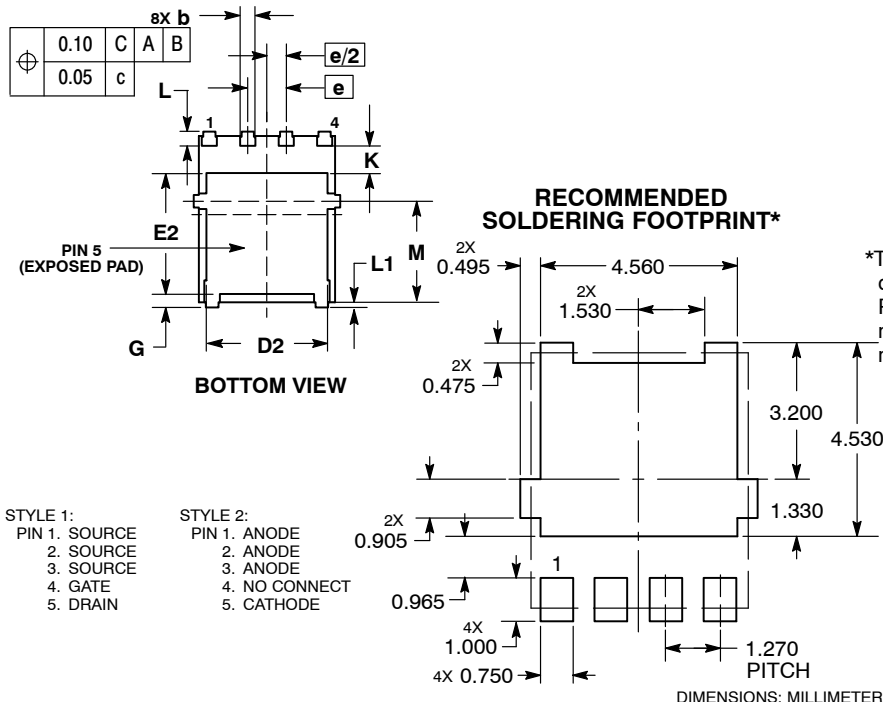

- STYLE 1:  
PIN 1. SOURCE  
2. SOURCE  
3. SOURCE  
4. GATE  
5. DRAIN
- STYLE 2:  
PIN 1. ANODE  
2. ANODE  
3. ANODE  
4. NO CONNECT  
5. CATHODE

\*For additional information on our Pb-Free strategy and soldering details, please download the ON Semiconductor Soldering and Mounting Techniques Reference Manual, SOLDERRM/D.

|                  |                          |  |
|------------------|--------------------------|--|
| DOCUMENT NUMBER: | 98AON14036D              | Electronic versions are uncontrolled except when accessed directly from the Document Repository. Printed versions are uncontrolled except when stamped "CONTROLLED COPY" in red. |
| DESCRIPTION:     | DFN5 5x6, 1.27P (SO-8FL) | PAGE 1 OF 1  |

onsemi and ONSEMI are trademarks of Semiconductor Components Industries, LLC dba onsemi or its subsidiaries in the United States and/or other countries. onsemi reserves the right to make changes without further notice to any products herein. onsemi makes no warranty, representation or guarantee regarding the suitability of its products for any particular purpose, nor does onsemi assume any liability arising out of the application or use of any product or circuit, and specifically disclaims any and all liability, including without limitation special, consequential or incidental damages. onsemi does not convey any license under its patent rights nor the rights of others.

**onsemi**, **Onsemi**, and other names, marks, and brands are registered and/or common law trademarks of Semiconductor Components Industries, LLC dba "**onsemi**" or its affiliates and/or subsidiaries in the United States and/or other countries. **onsemi** owns the rights to a number of patents, trademarks, copyrights, trade secrets, and other intellectual property. A listing of **onsemi**'s product/patent coverage may be accessed at [www.onsemi.com/site/pdf/Patent-Marking.pdf](http://www.onsemi.com/site/pdf/Patent-Marking.pdf). **onsemi** reserves the right to make changes at any time to any products or information herein, without notice. The information herein is provided "as-is" and **onsemi** makes no warranty, representation or guarantee regarding the accuracy of the information, product features, availability, functionality, or suitability of its products for any particular purpose, nor does **onsemi** assume any liability arising out of the application or use of any product or circuit, and specifically disclaims any and all liability, including without limitation special, consequential or incidental damages. Buyer is responsible for its products and applications using **onsemi** products, including compliance with all laws, regulations and safety requirements or standards, regardless of any support or applications information provided by **onsemi**. "Typical" parameters which may be provided in **onsemi** data sheets and/or specifications can and do vary in different applications and actual performance may vary over time. All operating parameters, including "Typicals" must be validated for each customer application by customer's technical experts. **onsemi** does not convey any license under any of its intellectual property rights nor the rights of others. **onsemi** products are not designed, intended, or authorized for use as a critical component in life support systems or any FDA Class 3 medical devices or medical devices with a same or similar classification in a foreign jurisdiction or any devices intended for implantation in the human body. Should Buyer purchase or use **onsemi** products for any such unintended or unauthorized application, Buyer shall indemnify and hold **onsemi** and its officers, employees, subsidiaries, affiliates, and distributors harmless against all claims, costs, damages, and expenses, and reasonable attorney fees arising out of, directly or indirectly, any claim of personal injury or death associated with such unintended or unauthorized use, even if such claim alleges that **onsemi** was negligent regarding the design or manufacture of the part. **onsemi** is an Equal Opportunity/Affirmative Action Employer. This literature is subject to all applicable copyright laws and is not for resale in any manner.

## PUBLICATION ORDERING INFORMATION

### LITERATURE FULFILLMENT:

Email Requests to: [orderlit@onsemi.com](mailto:orderlit@onsemi.com)

**onsemi Website:** [www.onsemi.com](http://www.onsemi.com)

### TECHNICAL SUPPORT

**North American Technical Support:**  
Voice Mail: 1 800-282-9855 Toll Free USA/Canada  
Phone: 011 421 33 790 2910

**Europe, Middle East and Africa Technical Support:**

Phone: 00421 33 790 2910

For additional information, please contact your local Sales Representative