

Evaluating the **ADuM7701** 16-Bit, Isolated, Sigma-Delta ADC

FEATURES

Fully featured evaluation board for the **ADuM7701**

On-board power supplies

Standalone capability

SDP-H1 controller board compatible

PC-based software for control and data analysis

EVALUATION KIT CONTENTS

EV-ADuM7701-8FMCZ evaluation board

ACE software download instructions

EQUIPMENT NEEDED

EVAL-SDP-CH1Z SDP-H1 controller board

USB cable (provided in **EVAL-SDP-CH1Z** kit)

12 V wall wart signal source (provided in **EVAL-SDP-CH1Z** kit)

PC running Windows Vista SP2 (32-bit or 64-bit), Windows 7

SP1 (32-bit or 64-bit), Windows 8.1 (32-bit or 64-bit), or

Windows 10 (32-bit or 64-bit) with a USB 2.0 port

DOCUMENTS NEEDED

ADuM7701 data sheet

SOFTWARE NEEDED

ACE software

ADuM7701 ACE plugin (provided in **ACE** software)

GENERAL DESCRIPTION

The EV-ADuM7701-8FMCZ is a fully featured evaluation board that allows the user to evaluate all features of the **ADuM7701** isolated analog-to-digital converter (ADC). The **EVAL-SDP-CH1Z** system demonstration platform high speed (**SDP-H1**) controller board controls the EV-ADuM7701-8FMCZ evaluation board via the J9 connector, and through the USB port of a PC using the **Analysis Control Evaluation** (**ACE**) software. The **ACE** software is available for download on the [ACE software page](#).

On-board components include an isolated, 5 kV, isoPower dc-to-dc converter (the **ADuM6000**), a 50 mA, 60 V, high efficiency buck regulator (the **ADP2360ACPZ-5.0**), and a 5 V, low noise, low dropout (LDO) regulator (the **ADP7104ARDZ-5.0**).

This user guide explains how to use the EV-ADuM7701-8FMCZ evaluation board to evaluate the **ADuM7701**. The **ADuM7701** is a high performance, second-order, Σ - Δ modulator that converts an analog input signal into a high speed, single-bit data stream with on-chip digital isolation based on Analog Devices, Inc., *iCoupler* technology. The device is powered by a 4.5 V to 5.5 V power supply (V_{DD1}) and accepts a pseudo differential input signal of up to ± 250 mV (± 320 mV at full scale). The pseudo differential input shunts voltage monitoring in high voltage applications where galvanic isolation is required.

The analog input is continuously sampled by a high performance analog modulator, and converts to a ones density digital output stream with a data rate of up to 21 MHz. The original information can be reconstructed with the appropriate digital filter to achieve an 86 dB signal-to-noise ratio (SNR) at 78.1 kSPS with a 20 MHz master clock (MCLK) for the **ADuM7701**. The serial input/output is powered by a supply of either 5 V or 3.3 V (V_{DD2}).

The serial interface is digitally isolated. The on-chip isolation provides performance characteristics superior to alternatives such as optocoupler devices due to high speed complementary metal-oxide semiconductor (CMOS) technology combined with monolithic transformer technology. The **ADuM7701** comes in both 16-lead and 8-lead, wide-body SOIC packages, and has an operating temperature range of -40° C to $+125^{\circ}$ C.

Complete specifications for the **ADuM7701** are provided in the **ADuM7701** data sheet and must be consulted in conjunction with this user guide when using the evaluation board. Full details on the **EVAL-SDP-CH1Z** board are available on the **SDP-H1** product page.

TABLE OF CONTENTS

Features	1	Evaluation Board Circuitry	6
Evaluation Kit Contents.....	1	Sockets and Connectors	6
Equipment Needed.....	1	Test Points	6
Documents Needed.....	1	Evaluation Board Software.....	7
Software Needed	1	Software Installation Procedures.....	7
General Description	1	Evaluation Board Setup Procedures	9
Revision History	2	ACE Software Operation.....	10
Evaluation Board Connection Diagram.....	3	Launching the Software	10
Evaluation Board Hardware.....	4	Chip View Window Features	11
Power Supplies	4	Waveform Tab.....	11
Input Signals.....	4	Histogram Tab	12
Link Configuration Options	5	FFT Tab.....	12
Setup Conditions.....	5	Exiting the Software.....	12

REVISION HISTORY

3/2019—Revision 0: Initial Version

EVALUATION BOARD CONNECTION DIAGRAM

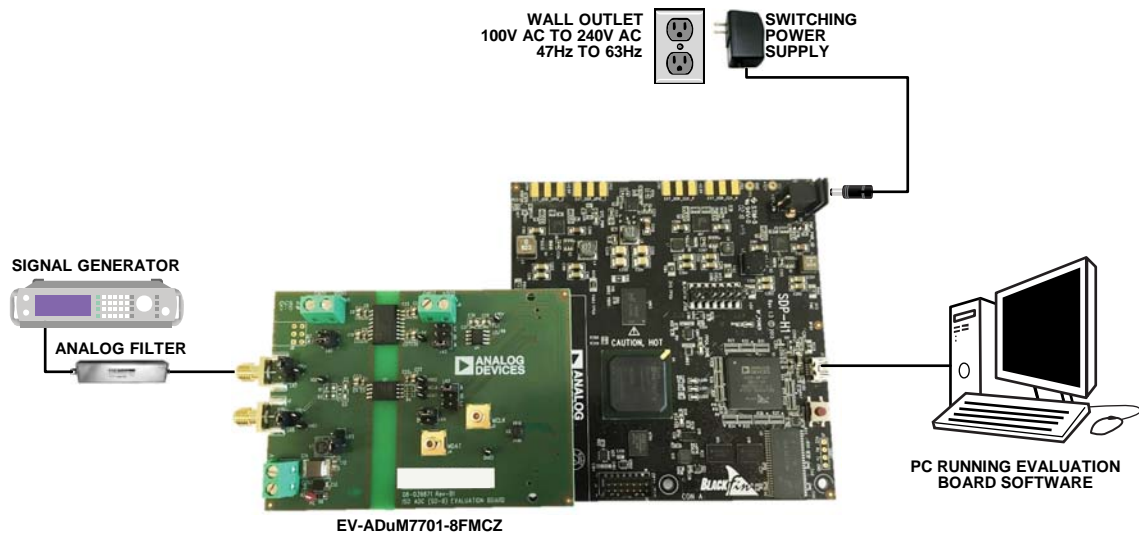

Figure 1.

EVALUATION BOARD HARDWARE

POWER SUPPLIES

Ensure that all link positions are set according to the required operating mode before applying power and signals to the EV-ADuM7701-8FMCZ evaluation board. See Table 2 for the complete list of link options.

The EV-ADuM7701-8FMCZ evaluation board is powered via the EVAL-SDP-CH1Z board. The EVAL-SDP-CH1Z board generates 12 V and 3.3 V supply rails. The 12 V supply is connected to the on-board ADP7104ARDZ-5.0 that powers the ADuM6000. The ADuM6000 generates an isolated 5 V supply to power the V_{DD1} rail of the ADuM7701. The 3.3 V supply rail generated by the EVAL-SDP-CH1Z board powers the V_{DD2} rail of the ADuM7701.

To power V_{DD1} externally, connect an external power supply in the 23 V to 25 V range to the HIGH_V J7 connector, or connect an external power supply in the 4.5 V to 5.5 V range to the J5 connector.

Power V_{DD2} externally with an external power supply in the 3 V to 5.5 V range via the J6 connector.

There are two main ground planes, GND1 and GND2, on the ADuM7701. These planes are isolated with a creepage and clearance of 8 mm.

When an external voltage is supplied to the J6 input connector, ensure that the voltage does not exceed 3.3 V when the EV-ADuM7701-8FMCZ evaluation board is connected to the EVAL-SDP-CH1Z board. Exceeding 3.3 V causes permanent damage to the EVAL-SDP-CH1Z board.

INPUT SIGNALS

Do not exceed an analog input of ±250 mV (±320 mV at full scale) to the ADuM7701. Connect an input signal of up to 500 mV p-p to the EV-ADuM7701-8FMCZ evaluation board via the J1 analog input connector.

The EV-ADuM7701-8FMCZ evaluation board has analog and digital ground planes that are physically isolated from each other. Power to the analog supply rail is supplied through the on-board ADuM6000. V_{DD1} can be supplied from the J5 external connector or from the high voltage (High_V) J7 external connector. The on-board ADP2360ACPZ-5.0 steps a 24 V supply connected to the J7 connector down to 5 V. See Table 1 and Table 2 for more information about supplying V_{DD1} externally.

Table 1. External Power Supplies (Optional)

Power Supply	Connector	Voltage Range	Purpose
V _{DD1}	J5	4.5 V to 5.5 V	Analog supply rail
V _{DD2}	J6	3 V to 5.5 V	Digital supply rail without the EVAL-SDP-CH1Z board connected
		3.15 V to 3.45 V	Digital supply rail with the EVAL-SDP-CH1Z board connected
HIGH_V	J7	23 V to 25 V	Analog supply rail (high voltage alternative to J5)

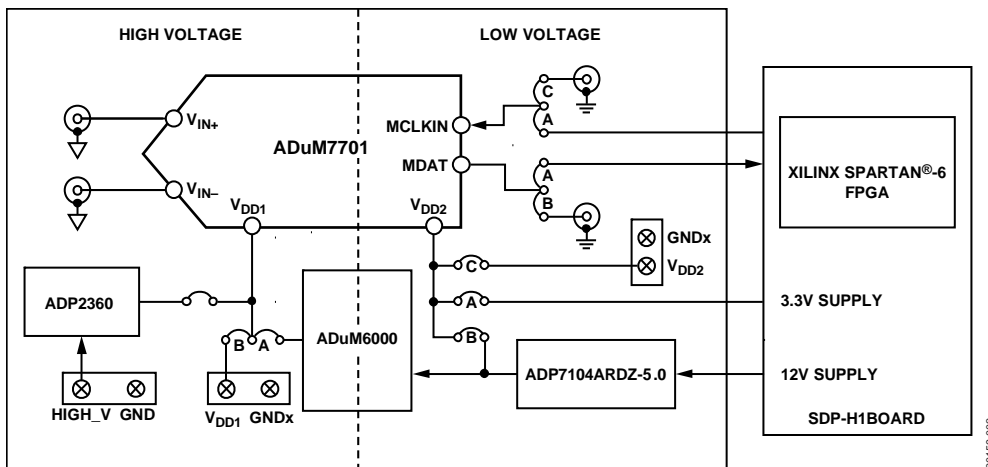

Figure 2. EV-ADuM7701-8FMCZ Evaluation Board Block Diagram

LINK CONFIGURATION OPTIONS

Multiple link options must be set correctly to select the appropriate operating setup before using the EV-ADuM7701-8FMCZ evaluation board. The functions of these options are outlined in Table 2.

SETUP CONDITIONS

Ensure that all link positions are set as required by the operating mode before applying power and signals to the EV-ADuM7701-8FMCZ evaluation board. The EV-ADuM7701-8FMCZ evaluation board can be operated in standalone mode or in SDP-H1 controlled mode and used with the [EVAL-SDP-CH1Z](#) board.

Table 2 shows the default positions the links are set to when the EV-ADuM7701-8FMCZ evaluation board is packaged. When the EV-ADuM7701-8FMCZ evaluation board is shipped, it is set up to operate in SDP-H1 controlled mode with power supplied from the [EVAL-SDP-CH1Z](#) board, and the on-board [ADuM6000](#) powers V_{DD1} .

Table 2. Link Options

Category	Link	Default Position	Function
Power Supplies	LK1	A	LK1 selects the ADuM7701 V_{DD1} supply source. Remove LK5 if using Position A or Position B. In Position A, the on-board ADuM6000 supplies V_{DD1} . In Position B, the J5 connector supplies V_{DD1} externally.
	LK5	Removed	Insert LK5 to power V_{DD1} with the on-board ADP2360ACPZ-5.0 via the J7 connector. Remove LK5 if V_{DD1} is powered via LK1.
	LK2	A	LK2 selects the ADuM7701 V_{DD2} supply source. In Position A, the EVAL-SDP-CH1Z board supplies V_{DD2} . In Position B, the on-board ADP7104ARDZ-5.0 supplies V_{DD2} . In Position C, the J6 connector supplies V_{DD2} externally.
Analog Input	LK7	Removed	Insert LK7 to short V_{IN+} to ground. Remove LK7 if a signal is applied to V_{IN+} .
	LK8	Inserted	Insert LK8 to short V_{IN-} to ground. Remove LK8 if a signal is applied to V_{IN-} .
Serial Interface	LK3	A	LK3 selects the MCLK source for the serial interface. In Position A, the EVAL-SDP-CH1Z board sources MCLK. In Position B, do not use. In Position C, the J3 Subminiature Version B (SMB) jack sources MCLK (standalone mode).
	LK4	A	LK4 routes the MDAT output for the serial interface. In Position A, MDAT is sent to the EVAL-SDP-CH1Z board. In Position B, MDAT is sent to the J4 SMB jack (standalone mode).

EVALUATION BOARD CIRCUITRY

SOCKETS AND CONNECTORS

Table 3 describes the connectors and sockets on the EV-ADuM7701-8FMCZ evaluation board.

Table 3. On-Board Connectors

Connector	Function
J1	Analog input V_{IN+}
J2	Analog input V_{IN-}
J3	MCLK input (standalone mode)
J4	MDAT output (standalone mode)
J5	V_{DD1} external source
J6	V_{DD2} external source
J7	V_{DD1} external source (high voltage)

The default interface to the EV-ADuM7701-8FMCZ evaluation board is achieved via the 160-way connector. The connector attaches the EV-ADuM7701-8FMCZ evaluation board to the [EVAL-SDP-CH1Z](#) board. When the EV-ADuM7701-8FMCZ evaluation board is used in standalone mode, communication is achieved via the J3 SMB jack and the J4 SMB jack. See Table 2 for more information on configuring the EV-ADuM7701-8FMCZ evaluation board for standalone mode.

TEST POINTS

There are several test points on the EV-ADuM7701-8FMCZ evaluation board. These test points provide easy access to the EV-ADuM7701-8FMCZ evaluation board signals for probing, evaluation, and debugging.

EVALUATION BOARD SOFTWARE SOFTWARE INSTALLATION PROCEDURES

Download the [ACE](#) software from the [ADuM7701](#) product page. Install the [ACE](#) software on the PC before using the EV-ADuM7701-8FMCZ evaluation board.

The installation process in the Installing the [ACE](#) Software section includes the [ACE](#) software installation and the [EVAL-SDP-CH1Z](#) driver installation.

Note that the [ACE](#) software and [EVAL-SDP-CH1Z](#) drivers must be installed before connecting the EV-ADuM7701-8FMCZ evaluation board and the [EVAL-SDP-CH1Z](#) board to the USB port of the PC to ensure that the evaluation system is properly recognized when it is connected to the PC.

Installing the [ACE](#) Software

To install the [ACE](#) software, take the following steps:

1. Download the [ACE](#) software to a Windows®-based PC.
2. Double click the [ACEInstall.exe](#) file to begin the installation. By default, the software is saved to the following location: **C:\Program Files (x86)\Analog Devices\ACE**.
3. A dialog box opens asking for permission to allow the program to make changes to the PC. Click **Yes** to start the installation process.
4. Click **Next >** to continue the installation (see Figure 3).

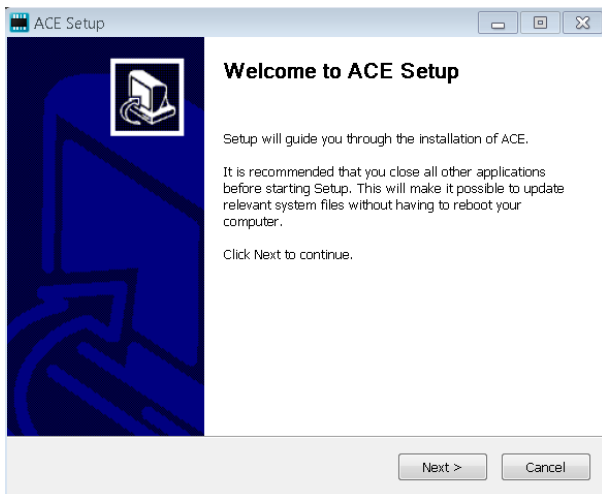

Figure 3. [ACE](#) Software Installation Confirmation

5. Read the software license agreement and click **I Agree** (see Figure 4).

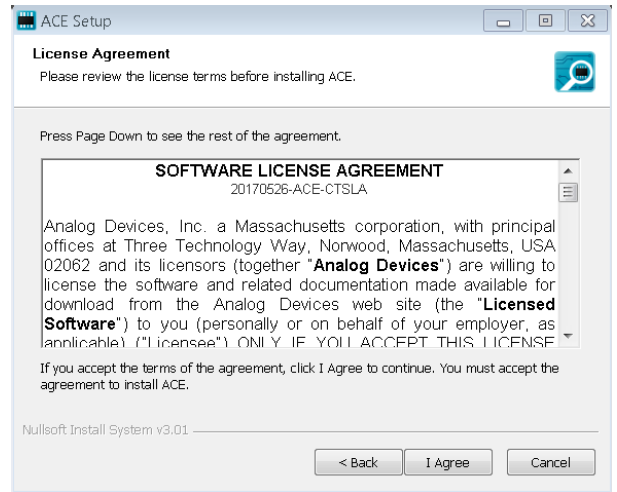

Figure 4. License Agreement

6. Click **Browse** to choose the installation location and then click **Next >** (see Figure 5).

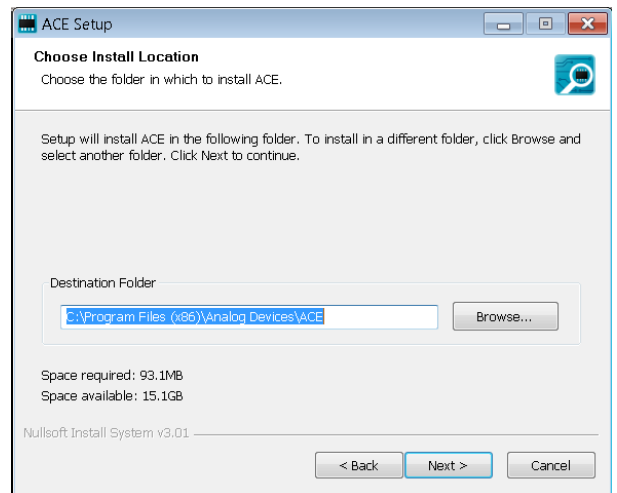

Figure 5. Choose Installation Location

- The components to install are preselected (see Figure 6). Click **Install**.

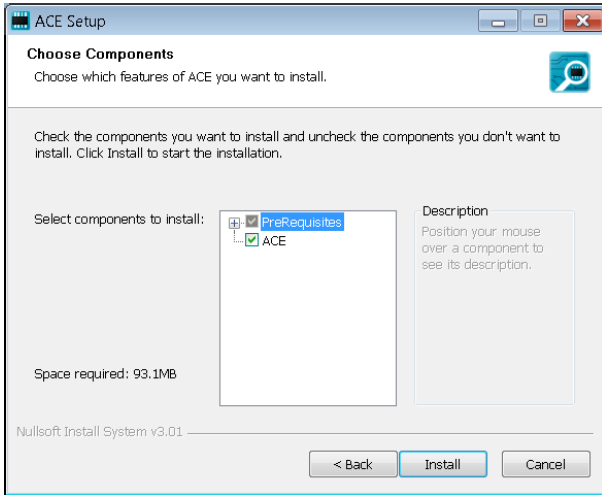

Figure 6. Choose Components

- The **Windows Security** window appears (see Figure 7). Click **Install**. Figure 8 shows the installation in progress. No action is required.

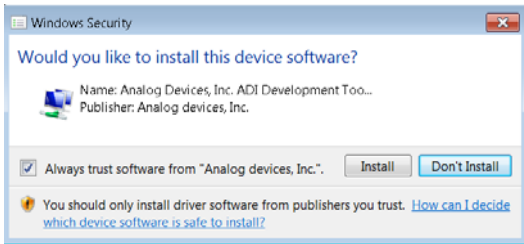

Figure 7. Windows Security Window

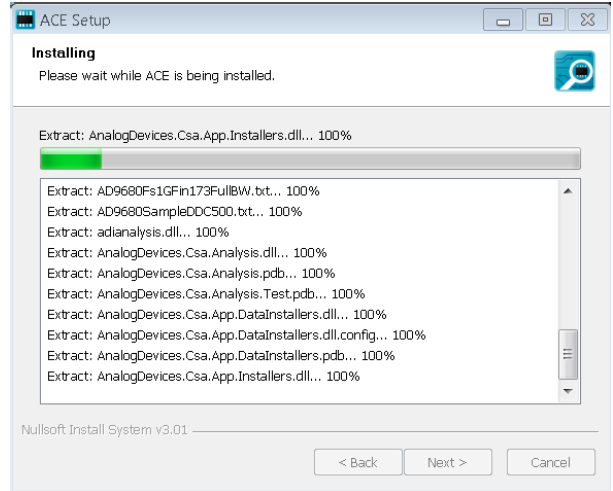

Figure 8. Installation in Progress

- When the installation is complete, click **Next >**, and then click **Finish** to complete the installation process (see Figure 9).

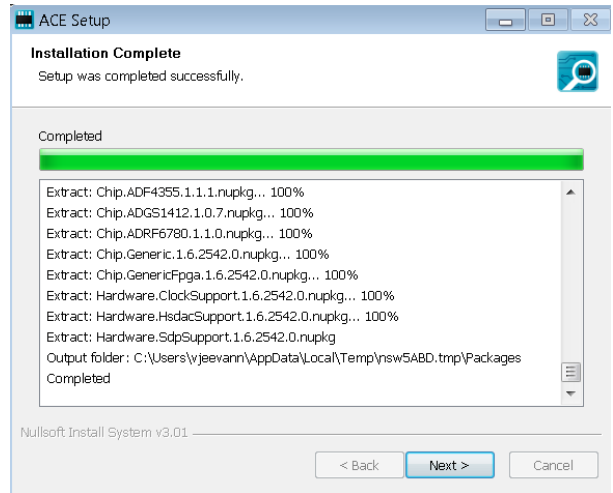

Figure 9. Installation Complete

EVALUATION BOARD SETUP PROCEDURES

The EV-ADuM7701-8FMCZ evaluation board connects to the EVAL-SDP-CH1Z board. The EVAL-SDP-CH1Z board is the communication link between the PC and the EV-ADuM7701-8FMCZ evaluation board. Figure 11 shows a diagram of the connections between the EV-ADuM7701-8FMCZ evaluation board and the EVAL-SDP-CH1Z board.

Connecting the EV-ADuM7701-8FMCZ Evaluation Board and the EVAL-SDP-CH1Z Board to the PC

When the ACE software is installed, use the following steps to set up the EV-ADuM7701-8FMCZ evaluation board and the EVAL-SDP-CH1Z board:

1. Ensure that all configuration links are in the appropriate positions, as described in Table 2.
2. Connect the EV-ADuM7701-8FMCZ evaluation board securely to the 160-way connector on the EVAL-SDP-CH1Z.
3. To power up the EVAL-SDP-CH1Z, insert the 12 V, dc barrel jack (included in the EVAL-SDP-CH1Z kit) into the barrel connector labeled +12V_VIN on the EVAL-SDP-CH1Z board.
Note that the EV-ADuM7701-8FMCZ evaluation board does not require an external power supply adapter.
4. Connect the EVAL-SDP-CH1Z board to the PC via the USB cable included in the EVAL-SDP-CH1Z kit.

Verifying the Board Connection

1. When the EVAL-SDP-CH1Z board is plugged into the PC, allow the **Found New Hardware Wizard** to run. If prompted by the operating system, choose to automatically search for the drivers for the EVAL-SDP-CH1Z board.

2. Navigate to the **Device Manager** window on the PC (see Figure 10).
3. A dialog box opens asking for permission to allow the program to make changes to the computer. Click **Yes**.
4. The **Computer Management** window opens. In the list labeled **System Tools**, click **Device Manager**. If the EVAL-SDP-CH1Z driver is installed and the board is properly connected to the PC, **Analog Devices SDP-H1** is shown in the **ADI Development Tools** list in the **Device Manager** window, as shown in Figure 10.

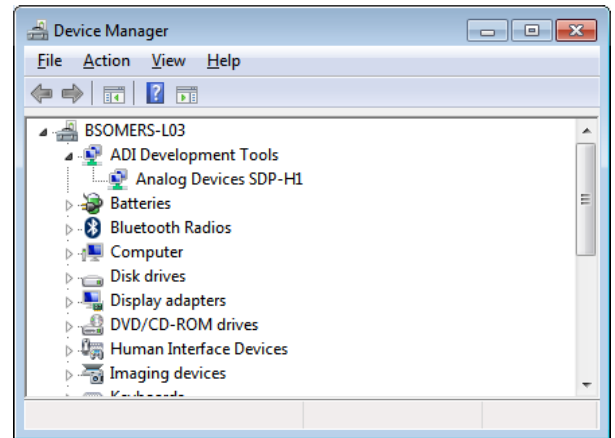

Figure 10. Device Manager Window

Disconnecting the EV-ADuM7701-8FMCZ

Disconnect power from the EVAL-SDP-CH1Z board or press the reset tact switch located alongside the mini USB port before disconnecting the EV-ADuM7701-8FMCZ evaluation board from the EVAL-SDP-CH1Z board.



Figure 11. EV-ADuM7701-8FMCZ Evaluation Board (Left) and EVAL-SDP-CH1Z Board (Right) Connection

ACE SOFTWARE OPERATION

LAUNCHING THE SOFTWARE

When the EV-ADuM7701-8FMCZ evaluation board and the EVAL-SDP-CH1Z board are properly connected to the PC, launch the ACE software. To launch the ACE software, take the following steps:

1. In the **Start** menu of the PC, click **All Programs > Analog Devices > ACE > ACE.exe** to bring up the ACE window shown in Figure 12.
2. Connect an input signal via the V_{IN+} J1 connector.

Note that if the EV-ADuM7701-8FMCZ evaluation board is not connected to the USB port via the EVAL-SDP-CH1Z board when the ACE software is launched, the **ADuM7701 Eval Board** icon does not show up in the **Attached Hardware** section. To make the icon appear, connect the EV-ADuM7701-8FMCZ evaluation board and the EVAL-SDP-CH1Z to the USB port of the PC, wait a few seconds, and then follow the instructions in the dialogue box that opens.

3. Double click the **ADuM7701 Eval Board** icon to open the chip view window shown in Figure 13.

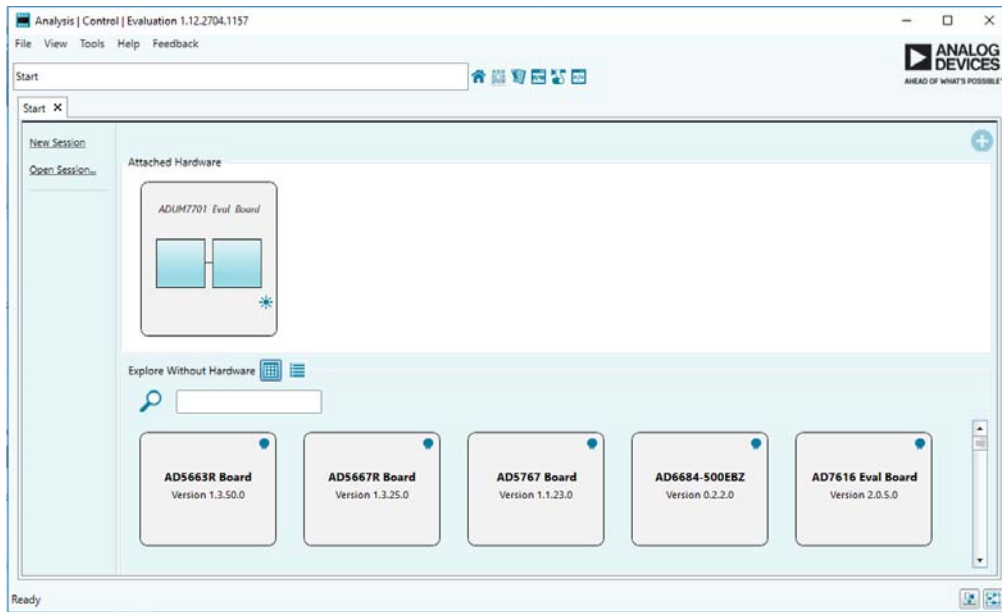

Figure 12. ACE Software Main Window

CHIP VIEW WINDOW FEATURES

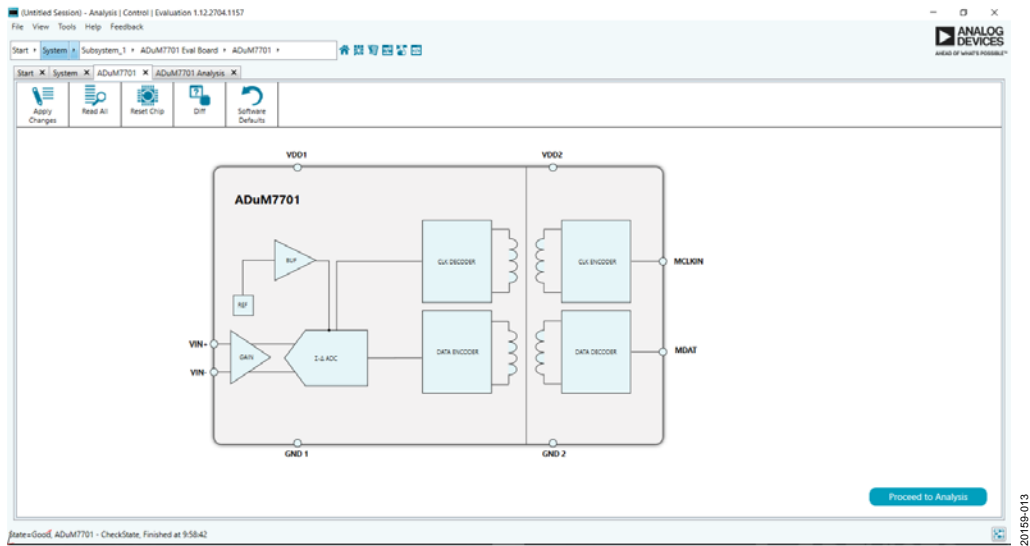

Figure 13. Chip View Window

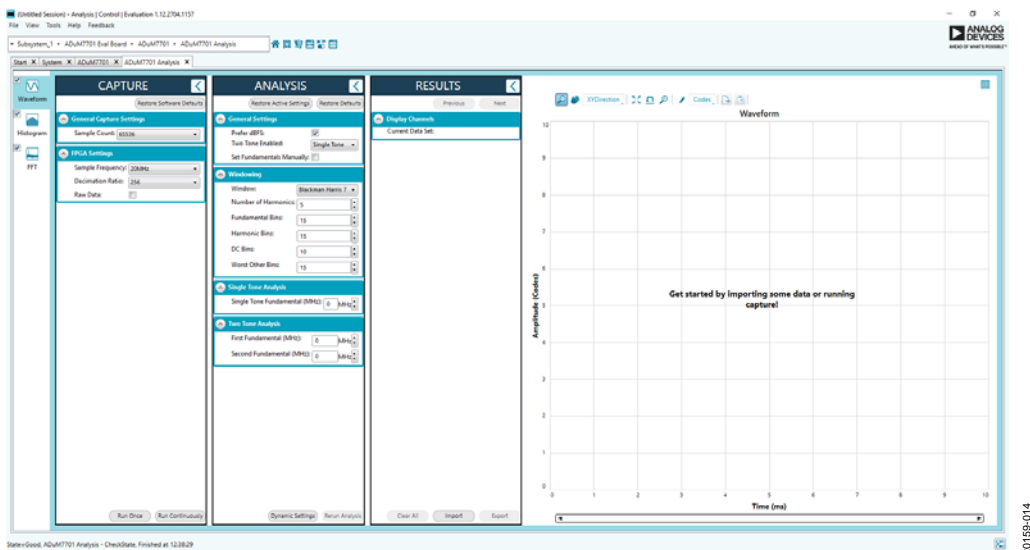

Figure 14. Analysis View Window

Click **Proceed to Analysis** in the chip view window to open the analysis view window shown in Figure 14. The analysis view contains the **Waveform** tab, **Histogram** tab, and **FFT** tab on the left side of the window.

WAVEFORM TAB

The **Waveform** tab displays data in form of time vs. discrete data values with the results (see Figure 15).

CAPTURE

The **CAPTURE** pane contains the capture settings. These settings reflect onto the registers automatically before data capture.

The **Sample Count** list in the **General Capture Settings** section allows the user to select the number of samples per channel per capture.

The **FPGA Settings** section contains the field programmable gate array (FPGA) settings that specify the **Sample Frequency** (MCLK frequency) used for the serial interface, and the decimation ratio used by the FPGA to filter the data.

Click **Run Once** at the bottom of the pane to start a data capture of the samples at the sample rate specified in the **Sample Count** field. These samples are stored on the [EVAL-SDP-CH1Z](#) board and are only transferred to the PC when the sample frame is complete.

Click **Run Continuously** to start a data capture that gathers samples continuously with one batch of data at a time.

RESULTS

Display Channels allows the user to select which channels to capture. Data for a specific channel is only shown if that channel is selected before the capture.

Waveform displays amplitude and sample frequency for the selected channel.

Click **Export** to export captured data. The waveform, histogram, and FFT data is stored in **.xml** files along with the values of parameters at capture.

The data waveform graph shows each successive sample of the ADC output. Zoom in on and pan over the waveform graph using the embedded waveform tools above the graph. Select the channels to display in **Display Channels**.

Click the display units dropdown list labeled **Codes** in Figure 15 to select whether the data graph displays in units of **Codes**, **Hex**, or **Volts**. The axis controls are dynamic.

Note that the corresponding axis width automatically adjusts to show the entire range of the ADC results after each batch of samples when either *xy* scale dynamic or *x* scale dynamic is selected.

HISTOGRAM TAB

The **Histogram** tab contains the histogram graph and the **RESULTS** pane (see Figure 16).

Click **RESULTS** to display the information related to the dc performance.

The **Histogram** graph displays the number of hits per code within the sampled data. This graph displays dc analysis and indicates the noise performance of the device.

FFT TAB

Figure 17 shows the **FFT** tab. This tab displays fast Fourier transform (FFT) information for the last batch of samples gathered.

The **General Settings** section allows the user to set up the preferred configuration of the FFT analysis. The fundamental is set manually.

The **Windowing** section allows the user to select the windowing type used in the FFT analysis, the number of harmonic bins, and the number of fundamental bins that must be included.

The **Single Tone Analysis** and **Two Tone Analysis** sections allow the user to select the fundamental frequency included in the FFT analysis. Use the **Two Tone Analysis** settings when there are two frequencies being analyzed.

The **Signal** section displays the sample frequency, sample count, fundamental frequency, and fundamental power.

The **Noise** section displays the SNR and other noise performance results.

The **Distortion** section displays the harmonic content of the sampled signal and dc power when viewing the FFT analysis.

EXITING THE SOFTWARE

To exit the software, click **File** and then click **Exit**



Figure 15. **Waveform** Tab

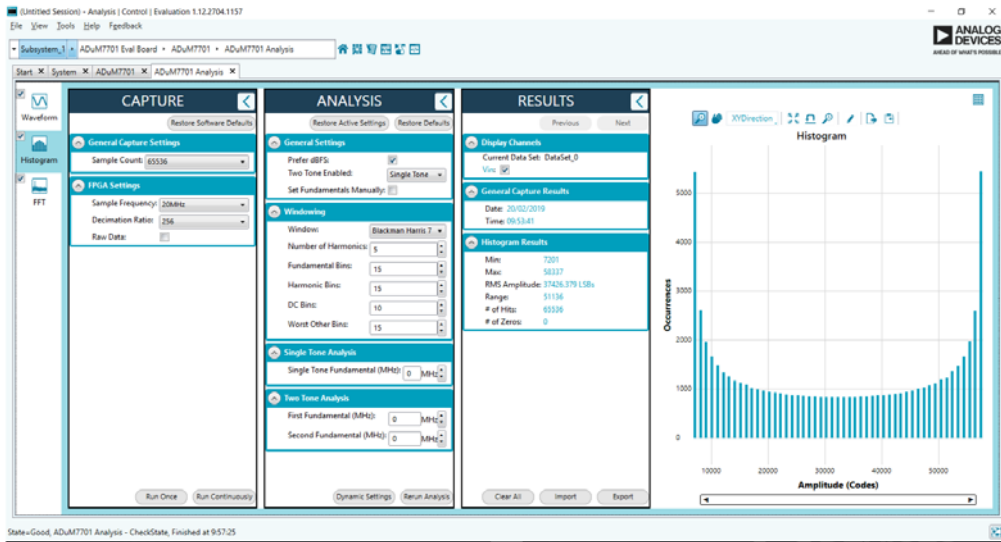

Figure 16. Histogram Tab



Figure 17. FFT Tab

NOTES

**ESD Caution**

ESD (electrostatic discharge) sensitive device. Charged devices and circuit boards can discharge without detection. Although this product features patented or proprietary protection circuitry, damage may occur on devices subjected to high energy ESD. Therefore, proper ESD precautions should be taken to avoid performance degradation or loss of functionality.

Legal Terms and Conditions

By using the evaluation board discussed herein (together with any tools, components documentation or support materials, the "Evaluation Board"), you are agreeing to be bound by the terms and conditions set forth below ("Agreement") unless you have purchased the Evaluation Board, in which case the Analog Devices Standard Terms and Conditions of Sale shall govern. Do not use the Evaluation Board until you have read and agreed to the Agreement. Your use of the Evaluation Board shall signify your acceptance of the Agreement. This Agreement is made by and between you ("Customer") and Analog Devices, Inc. ("ADI"), with its principal place of business at One Technology Way, Norwood, MA 02062, USA. Subject to the terms and conditions of the Agreement, ADI hereby grants to Customer a free, limited, personal, temporary, non-exclusive, non-sublicensable, non-transferable license to use the Evaluation Board FOR EVALUATION PURPOSES ONLY. Customer understands and agrees that the Evaluation Board is provided for the sole and exclusive purpose referenced above, and agrees not to use the Evaluation Board for any other purpose. Furthermore, the license granted is expressly made subject to the following additional limitations: Customer shall not (i) rent, lease, display, sell, transfer, assign, sublicense, or distribute the Evaluation Board; and (ii) permit any Third Party to access the Evaluation Board. As used herein, the term "Third Party" includes any entity other than ADI, Customer, their employees, affiliates and in-house consultants. The Evaluation Board is NOT sold to Customer; all rights not expressly granted herein, including ownership of the Evaluation Board, are reserved by ADI. CONFIDENTIALITY. This Agreement and the Evaluation Board shall all be considered the confidential and proprietary information of ADI. Customer may not disclose or transfer any portion of the Evaluation Board to any other party for any reason. Upon discontinuation of use of the Evaluation Board or termination of this Agreement, Customer agrees to promptly return the Evaluation Board to ADI. ADDITIONAL RESTRICTIONS. Customer may not disassemble, decompile or reverse engineer chips on the Evaluation Board. Customer shall inform ADI of any occurred damages or any modifications or alterations it makes to the Evaluation Board, including but not limited to soldering or any other activity that affects the material content of the Evaluation Board. Modifications to the Evaluation Board must comply with applicable law, including but not limited to the RoHS Directive. TERMINATION. ADI may terminate this Agreement at any time upon giving written notice to Customer. Customer agrees to return to ADI the Evaluation Board at that time. LIMITATION OF LIABILITY. THE EVALUATION BOARD PROVIDED HEREUNDER IS PROVIDED "AS IS" AND ADI MAKES NO WARRANTIES OR REPRESENTATIONS OF ANY KIND WITH RESPECT TO IT. ADI SPECIFICALLY DISCLAIMS ANY REPRESENTATIONS, ENDORSEMENTS, GUARANTEES, OR WARRANTIES, EXPRESS OR IMPLIED, RELATED TO THE EVALUATION BOARD INCLUDING, BUT NOT LIMITED TO, THE IMPLIED WARRANTY OF MERCHANTABILITY, TITLE, FITNESS FOR A PARTICULAR PURPOSE OR NONINFRINGEMENT OF INTELLECTUAL PROPERTY RIGHTS. IN NO EVENT WILL ADI AND ITS LICENSORS BE LIABLE FOR ANY INCIDENTAL, SPECIAL, INDIRECT, OR CONSEQUENTIAL DAMAGES RESULTING FROM CUSTOMER'S POSSESSION OR USE OF THE EVALUATION BOARD, INCLUDING BUT NOT LIMITED TO LOST PROFITS, DELAY COSTS, LABOR COSTS OR LOSS OF GOODWILL. ADI'S TOTAL LIABILITY FROM ANY AND ALL CAUSES SHALL BE LIMITED TO THE AMOUNT OF ONE HUNDRED US DOLLARS (\$100.00). EXPORT. Customer agrees that it will not directly or indirectly export the Evaluation Board to another country, and that it will comply with all applicable United States federal laws and regulations relating to exports. GOVERNING LAW. This Agreement shall be governed by and construed in accordance with the substantive laws of the Commonwealth of Massachusetts (excluding conflict of law rules). Any legal action regarding this Agreement will be heard in the state or federal courts having jurisdiction in Suffolk County, Massachusetts, and Customer hereby submits to the personal jurisdiction and venue of such courts. The United Nations Convention on Contracts for the International Sale of Goods shall not apply to this Agreement and is expressly disclaimed.