

50 Ohm SMA Field Replaceable 2-Hole Flange Mount Plug Receptacle - With EMI Gasket

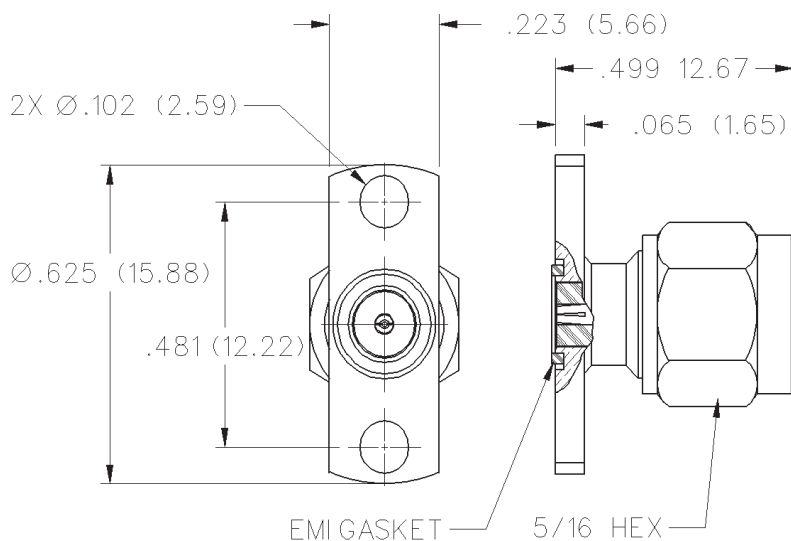

INCHES (MILLIMETERS)
CUSTOMER DRAWINGS AVAILABLE UPON REQUEST



ACCEPTS PIN SIZE	FREQUENCY RANGE	GOLD PLATED	NICKEL PLATED
.018 (0.46)	0-26.5 GHz	142-1801-621	142-1801-626

SMA - 50 Ohm Connectors

Field Replaceable - Application Notes

The field replaceable style of connector is known by many names in the industry, such as MIC launcher, hermetic seal launcher, spark plug launcher, etc. Some types, such as those known as “spark plugs”, have the hermetic seal incorporated into the connector. These types require special welding to install and can not be replaced without destroying the hermeticity of the circuit housing. True field replaceable connectors, such as those manufactured by Johnson Components™, are easy to install and replace. Because the hermetic seal is not incorporated into the connector design, the connector can be removed and replaced without destroying the hermetic seal or the hermeticity of the circuit housing.

All of the above mentioned connector types perform the same basic function - creating a transition from microstrip circuitry to a coaxial transmission line. Whenever possible, the hermetic seal pin diameter should be chosen as close as possible to the microstrip trace width. For optimum electrical performance, the transition from the hermetic seal to the microstrip trace must be properly compensated. Compensation involves adjusting the microstrip trace width to minimize any impedance discontinuities found in the transition area.

The plot shown below is representative of the typical return loss of an Johnson Components™ field replaceable connector. To produce the data shown below, a test fixture is created using the appropriate Johnson Components™ hermetic seal. The fixture consists of a suitably thick spacer plate with the hermetic seal mounted flush to both surfaces. Two connectors are mounted back to back around the fixture and the VSWR of this test assembly is measured. The return loss data shown is equivalent to the square root of the measured VSWR of the test assembly. Since the connectors tested are of identical design, it can be stated with fair accuracy that the data shown represents the response of a single field replaceable connector and its transition to the hermetic seal.



Although Johnson Components™ does not publish a VSWR specification for field replaceable connectors, typical connector VSWR can be expected to be less than $1.1 + .01f$ (f in GHz). A VSWR specification is not stated because an industry standard method for testing field replaceable connectors does not exist. The actual performance of the connector is dependent upon the application for the following reasons:

1. The choice of hermetic seal to be used by the customer is not specified by the connector manufacturer. Hermetic seals produced by different manufacturers will not have the same electrical characteristics. For optimum electrical performance, Johnson Components™ recommends the use of our standard 142-1000-001, 002, 003 and 004 hermetic seals for pin diameters of .012 (0.30), .015 (0.38), .018 (0.46) and .020 (0.51). Custom hermetic seal configurations can be quoted.
2. It is recommended that the hermetic seal be mounted flush with the circuit housing. Tolerance variations between the hermetic seal and machined housing do not always guarantee an optimum transition to the connector. Some manufacturers recommend an additional counterbore in the circuit housing to accommodate a solder washer during installation of the seal. Johnson Components™ does not recommend this type of installation because if the counterbore is not completely filled with solder, electrical discontinuities may be created.
3. The transition between the hermetic seal pin and the microstrip trace will affect electrical performance, as stated above. Several different methods of hermetic seal mounting and seal pin to microstrip trace attachment are used in the industry. Johnson Components™ can not recommend one method over the other as this is dependent upon the customer's application.

As always, quotes for non-standard field replaceable connectors and/or hermetic seals are welcome.

SMA - 50 Ohm Connectors

Specifications



INCHES (MILLIMETERS)
CUSTOMER DRAWINGS AVAILABLE UPON REQUEST

ELECTRICAL RATINGS

Impedance: 50 ohms

Frequency Range:

Dummy loads	0-2 GHz
Flexible cable connectors	0-12.4 GHz
Uncabled receptacles, RA semi-rigid and adapters	0-18.0 GHz
Straight semi-rigid cable connectors and field replaceable connectors	0-26.5 GHz

VSWR: (f = GHz)

	Straight Cabled Connectors	Right Angle Cabled Connectors
RG-178 cable	1.20 + .025f	1.20 + .03f
RG-316, LMR-100 cable	1.15 + .02f	1.15 + .03f
RG-58, LMR-195 cable	1.15 + .01f	1.15 + .02f
RG-142 cable	1.15 + .01f	1.15 + .02f
LMR-200, LMR-240 cable	1.10 + .03f	1.10 + .06f
.086 semi-rigid	1.07 + .008f	1.18 + .015f
.141 semi-rigid (w/contact)	1.05 + .008f	1.15 + .015f
.141 semi-rigid (w/o contact)	1.035 + .005f	
Jack-bulkhead jack adapter and plug-plug adapter	1.05 + .01f	
Jack-jack adapter and plug-jack adapter	1.05 + .005f	
Uncabled receptacles, dummy loads	N/A	
Field replaceable (see page 59)	N/A	

Working Voltage: (Vrms maximum)

Connectors for Cable Type	Sea Level	70K Feet
RG-178	170	45
RG-316; LMR-100, 195, 200	250	65
RG-58, RG-142, LMR-240, .086 semi-rigid, uncabled receptacles, .141 semi-rigid w/o contact	335	85
.141 semi-rigid with contact and adapters	500	125
Dummy loads	N/A	

Dielectric Withstanding Voltage: (VRMS minimum at sea level)

Connectors for RG-178	500
Connectors for RG-316; LMR-100, 195, 200	750
Connectors for RG-58, RG-142, LMR-240, .086 semi-rigid, field replaceable, uncabled receptacles	1000
Connectors for .141 semi-rigid with contact and adapters	1500
Connectors for .141 semi-rigid w/o contact, dummy loads	N/A

Corona Level: (Volts minimum at 70,000 feet)

Connectors for RG-178	125
Connectors for RG-316; LMR-100, 195, 200	190
Connectors for RG-58, RG-142, LMR-240, .086 semi-rigid, uncabled receptacles, .141 semi-rigid w/o contact	250
Connectors for .141 semi-rigid with contact and adapters	375
Dummy loads	N/A

Insertion Loss: (dB maximum)

Straight flexible cable connectors and adapters	0.06	\sqrt{f} (GHz), tested at 6 GHz
Right angle flexible cable connectors	0.15	\sqrt{f} (GHz), tested at 6 GHz
Straight semi-rigid cable connectors with contact	0.03	\sqrt{f} (GHz), tested at 10 GHz
Right angle semi-rigid cable connectors	0.05	\sqrt{f} (GHz), tested at 10 GHz
Straight semi-rigid cable connectors w/o contact	0.03	\sqrt{f} (GHz), tested at 16 GHz
Straight low loss flexible cable connectors	0.06	\sqrt{f} (GHz), tested at 1 GHz
Right Angle low loss flexible cable connectors	0.15	\sqrt{f} (GHz), tested at 1 GHz
Uncabled receptacles, field replaceable, dummy loads		N/A

Insulation Resistance: 5000 megohms minimum

Contact Resistance: (milliohms maximum) **Initial** **After Environmental**

Center contact (straight cabled connectors and uncabled receptacles)	3.0*	4.0*
Center contact (right angle cabled connectors and adapters)	4.0	6.0
Field replaceable connectors	6.0	8.0
Outer contact (all connectors)	2.0	N/A
Braid to body (gold plated connectors)	0.5	N/A
Braid to body (nickel plated connectors)	5.0	N/A

*N/A where the cable center conductor is used as a contact

RF Leakage: (dB minimum, tested at 2.5 GHz)

Flexible cable connectors, adapters and .141 semi-rigid connectors w/o contact	-60 dB
Field replaceable w/o EMI gasket	-70 dB
.086 semi-rigid connectors and .141 semi-rigid connectors with contact, and field replaceable with EMI Gasket	-90 dB
Two-way adapters	-90 dB
Uncabled receptacles, dummy loads	N/A

RF High Potential Withstanding Voltage: (Vrms minimum, tested at 4 and 7 MHz)

Connectors for RG-178	335
Connectors for RG-316; LMR-100, 195, 200	500
Connectors for RG-58, RG-142, LMR-240, .086 semi-rigid, .141 semi-rigid cable w/o contact, uncabled receptacles	670
Connectors for .141 semi-rigid with contact and adapters	1000

Power Rating (Dummy Load): 0.5 watt @ + 25°C, derated to 0.25 watt @ +125°C

MECHANICAL RATINGS

Engagement Design: MIL-C-39012, Series SMA

Engagement/Disengagement Force: 2 inch-pounds maximum

Mating Torque: 7 to 10 inch-pounds

Bulkhead Mounting Nut Torque: 15 inch-pounds

Coupling Proof Torque: 15 inch-pounds minimum

Coupling Nut Retention: 60 pounds minimum

Contact Retention:

6 lbs. minimum axial force (captivated contacts)

4 inch-ounce minimum torque (uncabled receptacles)

Cable Retention:

	Axial Force*(lbs)	Torque (in-oz)
Connectors for RG-178	10	N/A
Connectors for RG-316, LMR-100	20	N/A
Connectors for LMR-195, 200	30	N/A
Connectors for RG-58, LMR-240	40	N/A
Connectors for RG-142	45	N/A
Connectors for .086 semi-rigid	30	16
Connectors for .141 semi-rigid	60	55

*Or cable breaking strength whichever is less.

Durability: 500 cycles minimum

100 cycles minimum for .141 semi-rigid connectors w/o contact

ENVIRONMENTAL RATINGS (Meets or exceed the applicable paragraph of MIL-C-39012)

Temperature Range: - 65°C to + 165°C

Thermal Shock: MIL-STD-202, Method 107, Condition B

Corrosion: MIL-STD-202, Method 101, Condition B

Shock: MIL-STD-202, Method 213, Condition I

Vibration: MIL-STD-202, Method 204, Condition D

Moisture Resistance: MIL-STD-202, Method 106

†Avoid user injury due to misapplication. See safety advisory definitions inside front cover.

Cinch Connectivity Solutions

299 Johnson Avenue SW, Waseca, MN 56093 USA • 800.247.8256 • +1 507 833 8822 • cinchconnectivity.com

SMA - 50 Ohm Connectors

Specifications



INCHES (MILLIMETERS)
CUSTOMER DRAWINGS AVAILABLE UPON REQUEST

MATERIAL SPECIFICATIONS

Bodies: Brass per QQ-B-626, gold plated* per MIL-G-45204 .00001" min. or nickel plated per QQ-N-290

Contacts: Male - brass per QQ-B-626, gold plated per MIL-G-45204 .00003" min.

Female - beryllium copper per QQ-C-530, gold plated per MIL-G-45204 .00003" min.

Nut Retention Spring: Beryllium copper per QQ-C-533. Unplated

Insulators: PTFE fluorocarbon per ASTM D 1710 and ASTM D 1457 or Tefzel per ASTM D 3159 or PFA 340 per ASTM

Expansion Caps: Brass per QQ-B-613, gold plated per MIL-G-45204 .00001" min. or nickel plated per QQ-N-290

Crimp Sleeves: Copper per WW-T-799 or brass per QQ-B-613, gold plated per MIL-G-45204 .00001" min. or nickel plated per QQ-N-290

Mounting Hardware: Brass per QQ-B-626 or QQ-B-613, gold plated per MIL-G-45204 .00001" min. or nickel plated per QQ-N-290

Seal Rings: Silicone rubber per ZZ-R-765

EMI Gaskets: Conductive silicone rubber per MIL-G-83528, Type M

* All gold plated parts include a .00005" min. nickel underplate barrier layer.

Mating Engagement for SMA Series per MIL-C-39012

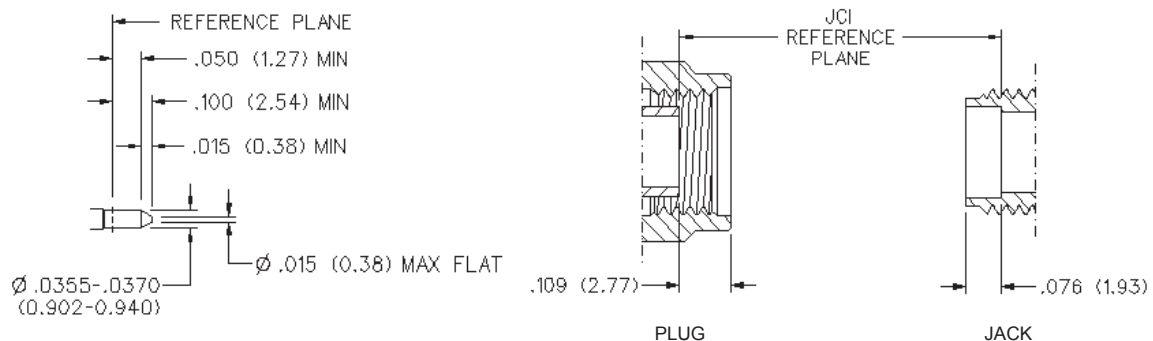
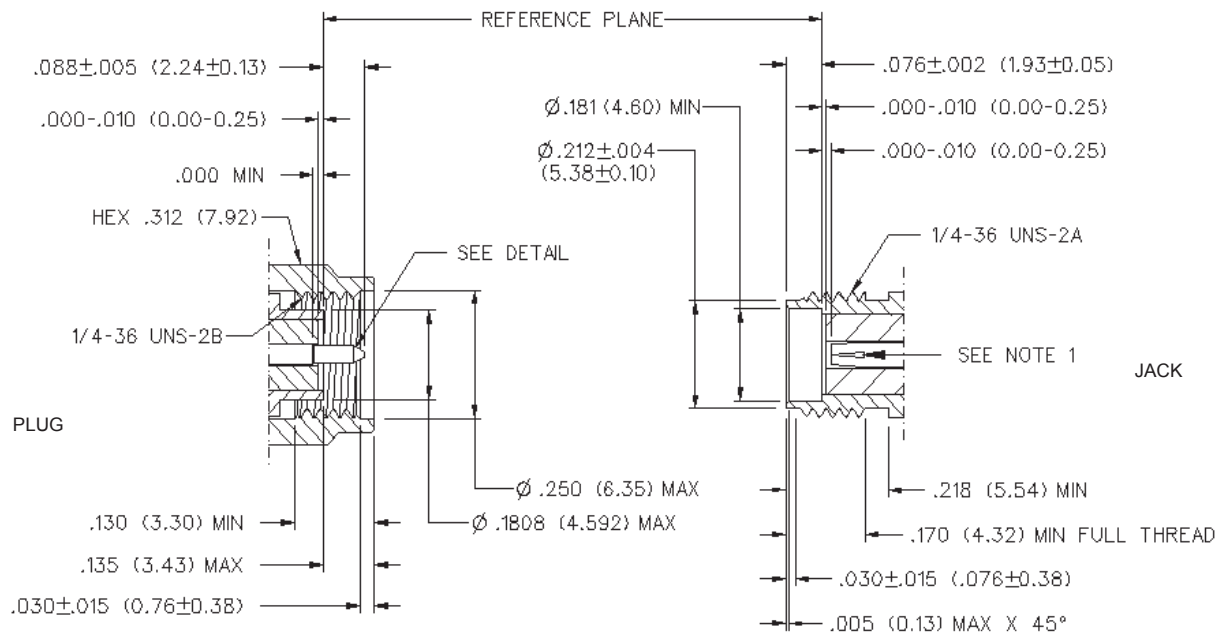

NOTES

1. ID OF CONTACT TO MEET VSWR, CONTACT RESISTANCE AND INSERTION WITHDRAWAL FORCES WHEN MATED WITH DIA .0355-.0370 MALE PIN.

Cinch Connectivity Solutions

299 Johnson Avenue SW, Waseca, MN 56093 USA • 800.247.8256 • +1 507 833 8822 • cinchconnectivity.com