

**NOTES:**

1. Material : Stainless Steel
2. Finish : Glod Irridite
3. Ends : Closed and Ground
4. Total Coils : 10.000
5. Sugg. Max. Deflection : 0.320 (in)
6. Sugg. Max. Load : 2.300 (lbs)
7. All Drawing Dimensions are in Inches [mm]

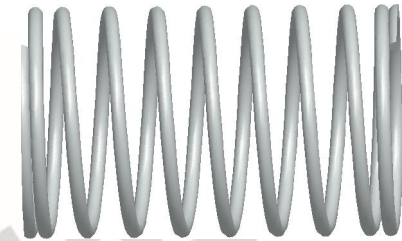

$\varnothing$  0.030  
 [0,76]  
 WIRE DIA

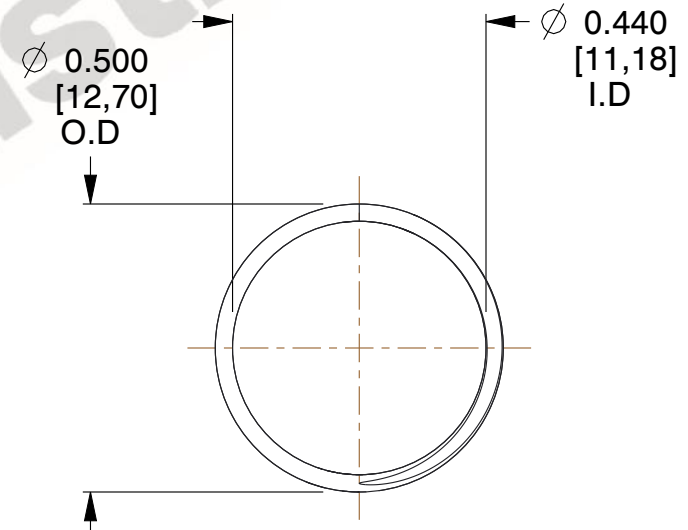
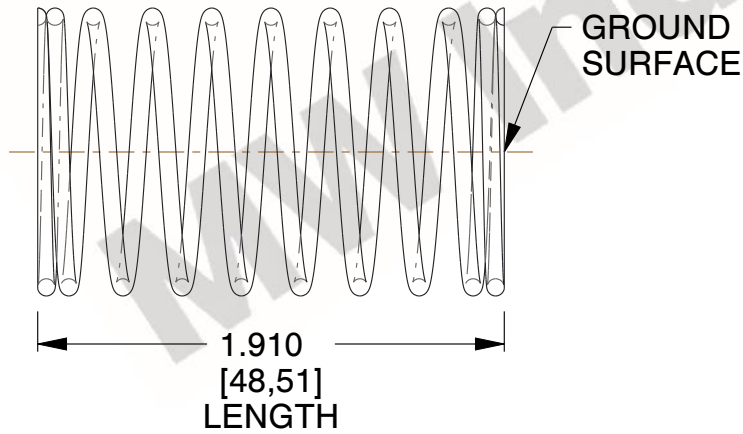

| COMPONENT                               |  | SPRINGS |           |
|---|--|---------|-----------|
| <b>11772</b><br><br>COMPRESSION SPRINGS |  | UNIT    | INCH [mm] |
|   |  | SHEET   | 1 of 1    |
|   |  |         |           |