



DESCRIPTION

The MP4323 is a frequency-configurable (350kHz to 2.5MHz), synchronous, step-down switching converter with integrated internal high-side and low-side power MOSFETs (HS-FET and LS-FET, respectively). It can achieve up to 3A of highly efficient output current (I_{OUT}) with peak current control mode.

The wide 3.3V to 36V input voltage (V_{IN}) range and 42V load dump tolerance accommodate a variety of step-down applications in automotive input environments. A 1 μ A shutdown current (I_{SD}) allows the device to be used in battery-powered applications.

High power conversion efficiency across a wide load range is achieved by scaling down the switching frequency (f_{SW}) under light-load conditions to reduce the switching and gate driver losses.

An open-drain power good (PG) signal indicates whether the output voltage (V_{OUT}) is between 94.5% and 105.5% of its nominal voltage.

Frequency foldback prevents inductor current (I_L) runaway during start-up. Thermal shutdown provides reliable, fault-tolerant operation.

A high duty cycle and low-dropout mode are provided for automotive cold-crank conditions.

The MP4323 is available in a QFN-12 (2mmx3mm) package.

FEATURES

- Designed for Automotive Applications:
 - 42V Load Dump Tolerance
 - Supports 3.1V Cold Crank
 - 3A Continuous Output Current (I_{OUT})
 - Wide 3V to 36V Operating Input Voltage (V_{IN}) Range
 - -40°C to +125°C Junction Temperature (T_J) Range
- Increases Battery Life:
 - 1 μ A Shutdown Current (I_{SD})
 - 20 μ A Sleep Mode Current
 - Advanced Asynchronous Modulation (AAM) Mode for Increased Efficiency under Light-Load Conditions
- High Performance for Improved Thermals:
 - Integrated 70m Ω HS-FET and 50m Ω LS-FET
 - 65ns Minimum On Time (t_{ON_MIN}) and 50ns Minimum Off Time (t_{OFF_MIN})
- Optimized for EMC/EMI Reduction:
 - Frequency Spread Spectrum (FSS) Modulation
 - Symmetric VIN Pins (Pin 2 and Pin 10)
 - CISPR25 Class 5 Compliant
 - 350kHz to 2.5MHz Configurable Switching Frequency (f_{SW})
 - MeshConnect™ Flip-Chip Package
- Additional Features:
 - Power Good (PG) Output
 - Low-Dropout (LDO) Mode
 - Over-Current Protection (OCP) with Hiccup Mode
 - Available in a QFN-12 (2mmx3mm) Package
 - Available in a Wettable Flank Package

APPLICATIONS

- USB Chargers
- Automotive Applications
- Battery-Powered Systems
- General Consumer Applications

All MPS parts are lead-free, halogen-free, and adhere to the RoHS directive. For MPS green status, please visit the MPS website under Quality Assurance. "MPS", the MPS logo, and "Simple, Easy Solutions" are trademarks of Monolithic Power Systems, Inc. or its subsidiaries.

TYPICAL APPLICATION

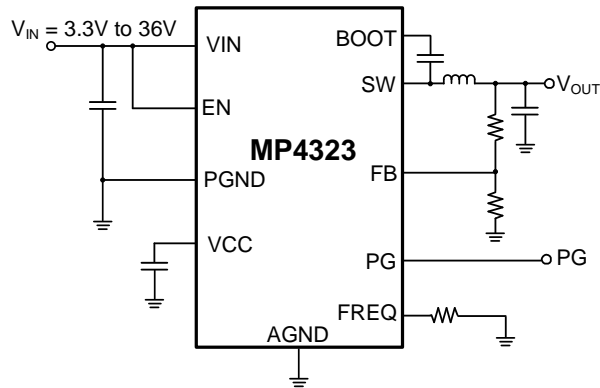

Figure 1: Typical Application (Adjustable Output)

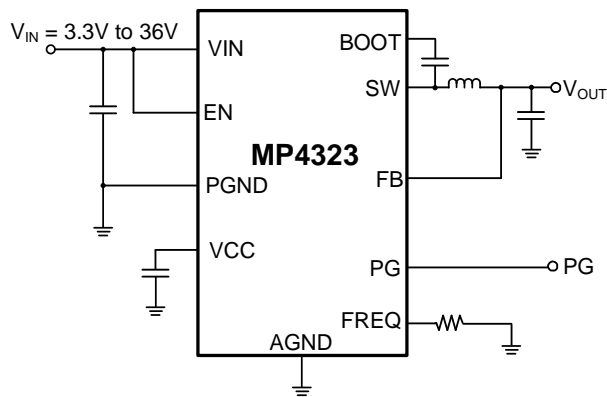
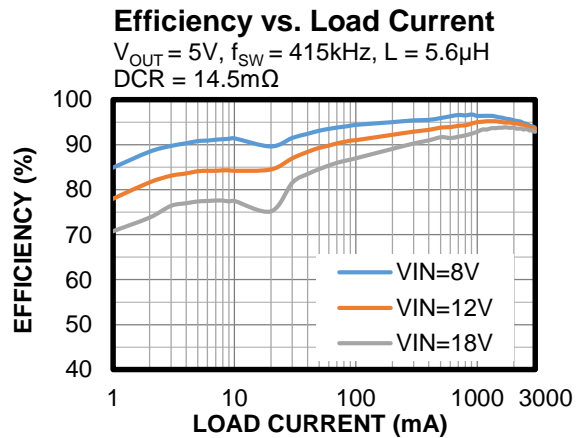

Figure 2: Typical Application (Fixed Output)

ORDERING INFORMATION

Part Number * (1)	Package	Top Marking	MSL Rating**
MP4323GDE ***	QFN-12 (2mmx3mm)	See Below	1

* For Tape & Reel, add suffix -Z (e.g. MP4323GDE-Z).

**Moisture Sensitivity Level Rating

***Wettable flank

Note:

1) Contact MPS for details on the fixed output versions.

TOP MARKING (MP4323GDE)

BPN
YWW
LLLL

BPN: Production code of MP4323GDE

Y: Year code

WW: Week code

LLLL: Lot number

PACKAGE REFERENCE

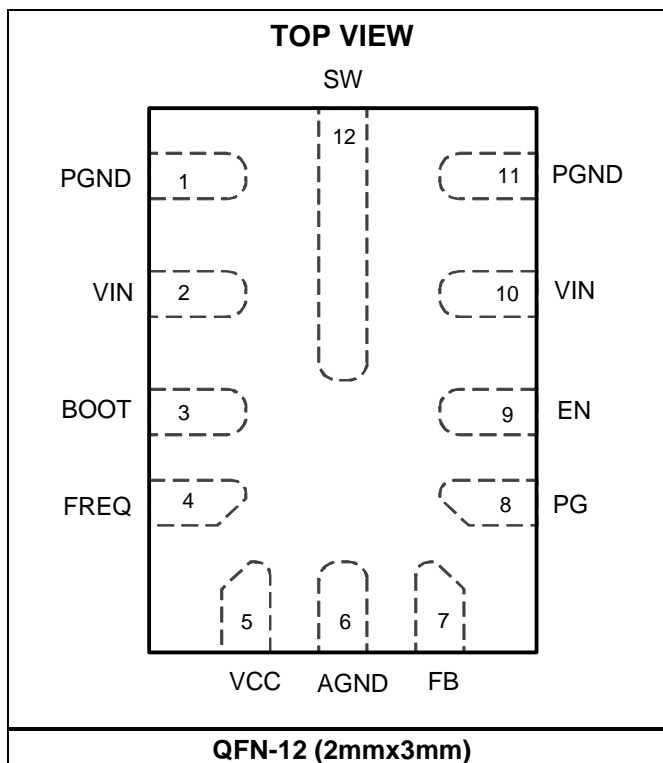

PIN FUNCTIONS

Pin #	Name	Description
1, 11	PGND	Power ground.
2, 10	VIN	Input supply. The VIN pin supplies power to the internal control circuitry and the power MOSFET connected to the SW pin. The two VIN pins are connected internally. Connect a decoupling capacitor between VIN and PGND to minimize switching spikes. Place this capacitor as close to VIN as possible.
3	BOOT	Bootstrap. The BOOT pin is the positive power supply for the high-side MOSFET (HS-FET) driver connected to SW. Connect a bypass capacitor between the BOOT and SW pins.
4	FREQ	Switching frequency (f_{sw}) configuration. Connect a resistor from the FREQ pin to AGND to set f _{sw} .
5	VCC	Bias supply. The VCC pin is the output of the internal regulator that supplies power to the internal control circuitry and gate drivers. Connect a ≥1μF decoupling capacitor between VCC and AGND. Place this capacitor as close to VCC as possible.
6	AGND	Analog ground.
7	FB	Feedback input. The FB pin is the negative input of the error amplifier (EA) (typically 0.8V). For a fixed output, connect FB to the output voltage (V _{OUT}) directly. For an adjustable output, connect FB to the middle point of the external feedback divider, between the output and AGND. V _{OUT} can be set via the external feedback divider.
8	PG	Power good output. The PG pin is an open-drain output. Connect PG to a power source via a pull-up resistor. PG goes high if V _{OUT} is between 94.5% and 105.5% of the nominal voltage, then PG is pulled high. If V _{OUT} exceeds 107% or drops below 93% of the nominal voltage, the PG is pulled low. Float PG if not used.
9	EN	Enable. Pull the EN pin below 0.85V to turn the converter off; pull EN above 1.02V to turn it on. EN does not require an internal pull-up or pull-down resistor. Do not float EN.
12	SW	Switching node. The SW pin is the source of the HS-FET and the drain of the low-side MOSFET (LS-FET).

ABSOLUTE MAXIMUM RATINGS ⁽²⁾

V _{IN} , EN.....	42V for automotive load dump ⁽³⁾
V _{IN} , EN.....	-0.3V to +40V
SW.....	-0.3V to V _{IN_MAX} + 0.3V
BOOT.....	V _{SW} + 5.5V
FREQ, VCC.....	5.5V
All other pins.....	-0.3V to +6V
Continuous power dissipation (T _A = 25°C) ⁽⁴⁾	
QFN-12 (2mmx3mm)	3.5W ⁽⁹⁾
Operating junction temperature.....	150°C
Lead temperature.....	260°C
Storage temperature.....	-65°C to +150°C

ESD Ratings

Human body model (HBM)	Class 2 ⁽⁵⁾
Charged device model (CDM).....	Class C2b ⁽⁶⁾

Recommended Operating Conditions

Supply voltage (V _{IN}).....	3.3V to 36V
Minimum start-up V _{IN}	3.8V
Minimum V _{IN} after start-up	3.1V
Output voltage (V _{OUT}).....	0.8V to 0.95 x V _{IN}
Operating junction temp (T _J)..	-40°C to +125°C ⁽⁷⁾

Thermal Resistance	θ_{JA}	θ_{JC}
QFN-12 (2mmx3mm)		
JESD51-7 ⁽⁸⁾	60.....	7.3..... °C/W
EVQ4323-D-00A ⁽⁹⁾	35.5.....	3.5..... °C/W

Notes:

- 2) Absolute maximum ratings are rated under room temperature, unless otherwise noted. Exceeding these ratings may damage the device.
- 3) Refer to ISO16750.
- 4) The maximum allowable power dissipation is a function of the maximum junction temperature, T_J (MAX), the junction-to-ambient thermal resistance, θ_{JA}, and the ambient temperature, T_A. The maximum allowable continuous power dissipation at any ambient temperature is calculated by P_D (MAX) = (T_J (MAX) - T_A) / θ_{JA}. Exceeding the maximum allowable power dissipation can cause excessive die temperature, which may cause the device to go into thermal shutdown. Internal thermal shutdown circuitry protects the device from permanent damage.
- 5) Per ANSI/ESDA/JEDEC JS-001.
- 6) Per with ANSI/ESDA/JEDEC JS-002.
- 7) The device can operate at junction temperatures above 125°C. Contact an MPS FAE for details.
- 8) Measured on JESD51-7, 4-layer PCB. The values given in this table are only valid for comparison with other packages and cannot be used for design purposes. These values are calculated in accordance with JESD51-7, and simulated on a specified JEDEC board. They do not represent the performance obtained in an actual application.
- 9) Measured on the EVQ4323-D-00A, 8.3cmx8.3cm, 2oz copper thickness, 4-layer PCB.

ELECTRICAL CHARACTERISTICS

V_{IN} = 12V, V_{EN} = 2V, T_J = -40°C to +125°C ⁽¹⁰⁾, typical values are tested at T_J = 25°C, unless otherwise noted.

Parameter	Symbol	Condition	Min	Typ	Max	Units
Input Supply						
V _{IN} under-voltage lockout (UVLO) rising threshold	V _{IN_UVLO_RISING}		3.4	3.65	3.9	V
V _{IN} UVLO falling threshold	V _{IN_UVLO_FALLING}		2.6	2.9	3.1	V
V _{IN} UVLO hysteresis	V _{IN_UVLO_HYS}			750		mV
Quiescent current	I _Q	V _{FB} = 0.85V, no load, T _J = 25°C		20	28	μA
		V _{FB} = 0.85V, no load, T _J = -40°C to +125°C ⁽¹¹⁾			34	μA
Quiescent current (switching) ⁽¹¹⁾	I _{Q_SWITCHING}	Switching, R _{FB1} = 1MΩ, R _{FB2} = 191kΩ, no load		25		μA
Shutdown current	I _{SD}	V _{EN} = 0V		1	10	μA
V _{IN} over-voltage protection (OVP) rising threshold	V _{IN_OVP_RISING}		35.5	37.5	40	V
V _{IN} OVP falling threshold	V _{IN_OVP_FALLING}		34.5	36.5	39	V
V _{IN} OVP hysteresis	V _{IN_OVP_HYS}			1		V
Switching Frequency (f_{sw})						
Switching frequency	f _{sw}	R _{FREQ} = 86.6kΩ, without FSS	332	415	498	kHz
		R _{FREQ} = 34.8kΩ, without FSS	900	1000	1100	kHz
		R _{FREQ} = 15kΩ, without FSS	1980	2200	2420	kHz
Frequency spread spectrum (FSS) range			±10			%
FSS modulation frequency				15		kHz
Minimum on time ⁽¹¹⁾	t _{ON_MIN}			65	80	ns
Minimum off time ⁽¹¹⁾	t _{OFF_MIN}			50	70	ns
Maximum duty cycle	D _{MAX}		98	99.5		%
Switch leakage current	I _{SW_LKG}	V _{EN} = 0V, V _{SW} = V _{BOOT} = 0V or V _{IN} , T _J = 25°C		0.01	1	μA
		V _{EN} = 0V, V _{SW} = V _{BOOT} = 0V or V _{IN} , T _J = -40°C to +125°C		0.01	5	μA
High-side MOSFET (HS-FET) on resistance	R _{DS(ON)_HS}	V _{BOOT} - V _{SW} = 5V		70	130	mΩ
Low-side MOSFET (LS-FET) on resistance	R _{DS(ON)_LS}	V _{CC} = 5V		50	90	mΩ
Output and Regulation						
Feedback (FB) voltage	V _{FB}	T _J = 25°C, adjustable output version	0.794	0.8	0.806	V
		T _J = -40°C to +125°C, adjustable output version	0.790	0.8	0.810	V
FB input current	I _{FB}	Adjustable output version		0	100	nA
V _{OUT} discharge current	I _{DISCHARGE}	V _{EN} = 0V, V _{OUT} = 0.3V	2	4		mA

ELECTRICAL CHARACTERISTICS (continued)

V_{IN} = 12V, V_{EN} = 2V, T_J = -40°C to +125°C ⁽¹⁰⁾, typical values are tested at T_J = 25°C, unless otherwise noted.

Parameter	Symbol	Condition	Min	Typ	Max	Units
Bootstrap (BOOT)						
BOOT to SW refresh rising threshold	V _{BOOT_RISING}			2.5	2.9	V
BOOT to SW refresh falling threshold	V _{BOOT_FALLING}			2.3	2.7	V
BOOT to SW refresh hysteresis	V _{BOOT_HYS}			0.2		V
Enable (EN)						
EN rising threshold	V _{EN_RISING}		0.97	1.02	1.07	V
EN falling threshold	V _{EN_FALLING}		0.8	0.85	0.9	V
EN threshold hysteresis	V _{EN_HYS}			170		mV
Soft Start (SS) and VCC						
Soft-start time	t _{SS}	EN high to SS is complete	3	5	7	ms
VCC voltage	V _{CC}	I _{VCC} = 0mA	4.7	5	5.3	V
VCC regulation		I _{VCC} = 30mA		1		%
VCC current limit	I _{LIMIT_VCC}	V _{CC} = 4V	50	70		mA
Power Good (PG)						
PG rising threshold	V _{PG_RISING}	V _{OUT} rising, V _{FB} / V _{REF}	93	94.5	96	% of V _{REF}
		V _{OUT} falling, V _{FB} / V _{REF}	104	105.5	107	% of V _{REF}
PG falling threshold	V _{PG_FALLING}	V _{OUT} falling	91.5	93	94.5	% of V _{REF}
		V _{OUT} rising	105.5	107	108.5	% of V _{REF}
PG threshold hysteresis	V _{PG_HYS}	V _{FB} / V _{REF}		1.5%		% of V _{REF}
PG output voltage low	V _{PG_LOW}	I _{SINK} = 1mA		0.1	0.3	V
PG rising deglitch time	t _{PG_RISING}			70		μs
PG falling deglitch time	t _{PG_FALLING}			60		μs
Protections						
HS-FET peak current limit	I _{LIMIT_HS}	30% duty cycle	4.3	5.8	7.3	A
LS-FET valley current limit	I _{LIMIT_LS}		3	4.4	5.7	A
Zero current detection (ZCD) current	I _{ZCD}		-0.05	0.05	+0.15	A
Thermal shutdown ⁽¹¹⁾	T _{SD}		160	175	185	°C
Thermal shutdown hysteresis ⁽¹¹⁾	T _{SD_HYS}			20		°C

Notes:

10) Guaranteed by over-temperature correlation. Not tested in production.

11) Guaranteed by design and characterization. Not tested in production.

TYPICAL CHARACTERISTICS

$V_{IN} = 12V$, unless otherwise noted.

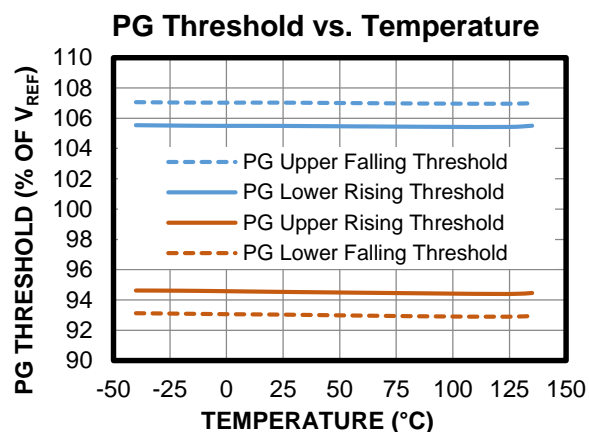
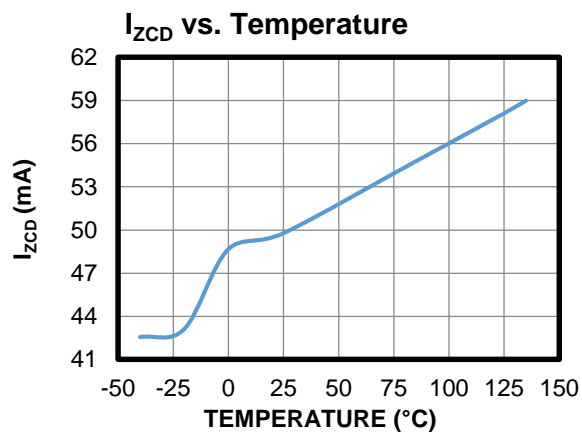
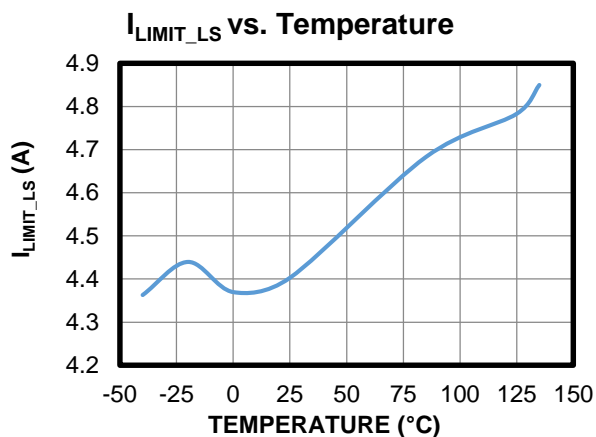
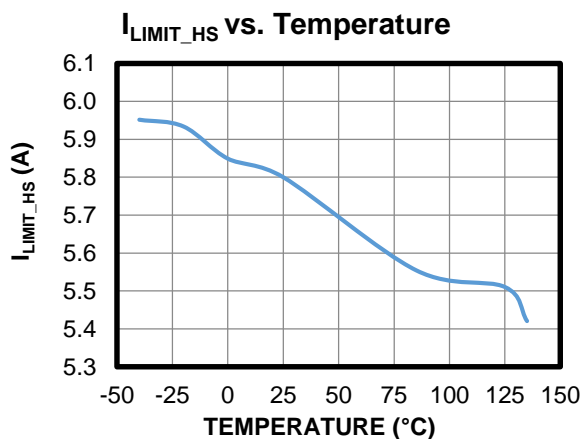
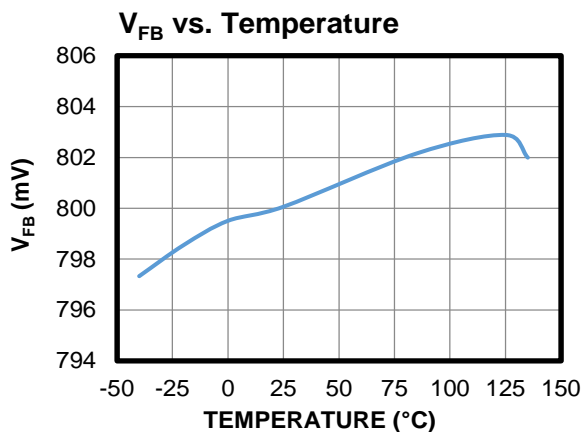
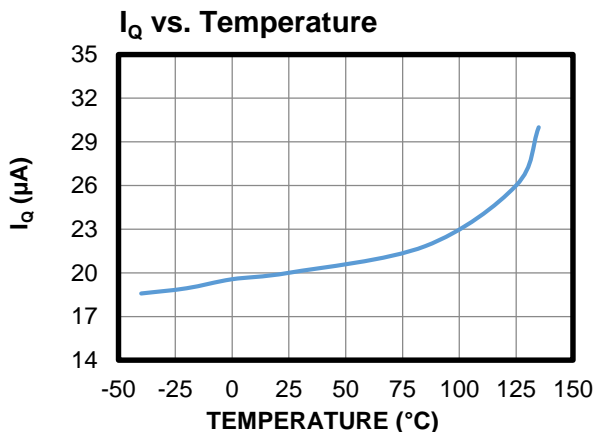

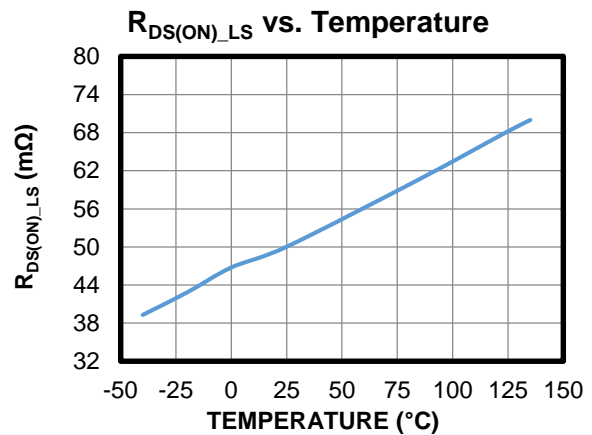
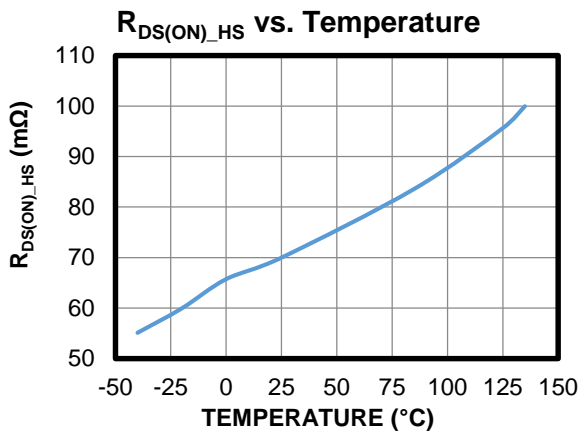
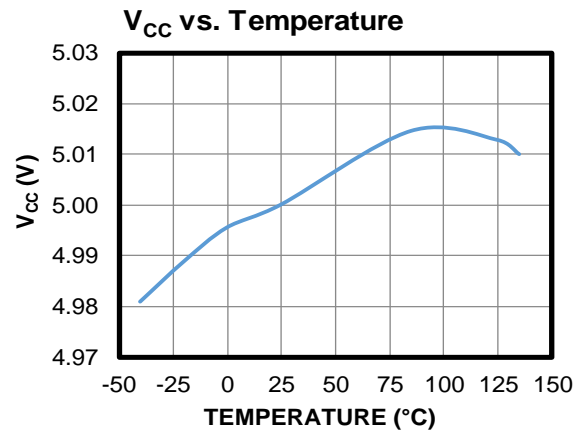
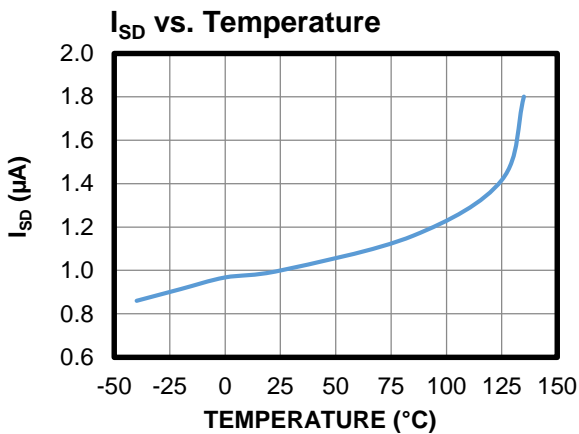
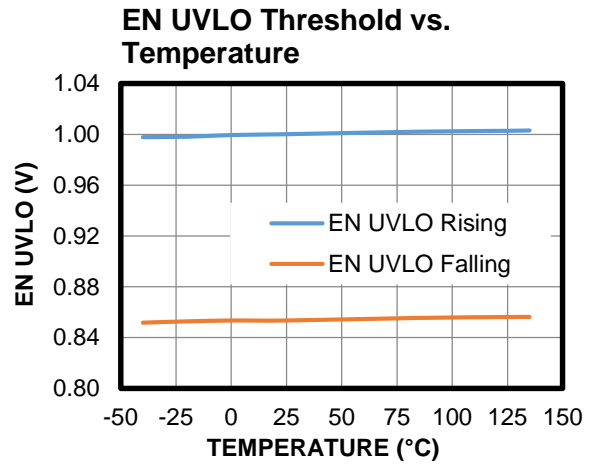
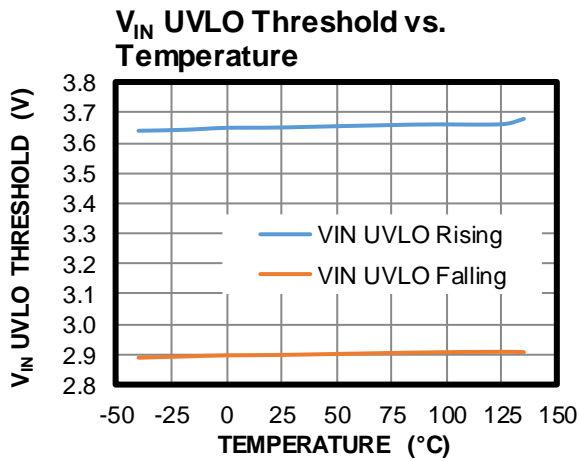
TYPICAL CHARACTERISTICS (continued)
 $V_{IN} = 12V$, unless otherwise noted.

TYPICAL CHARACTERISTICS *(continued)*

V_{IN} = 12V, unless otherwise noted.

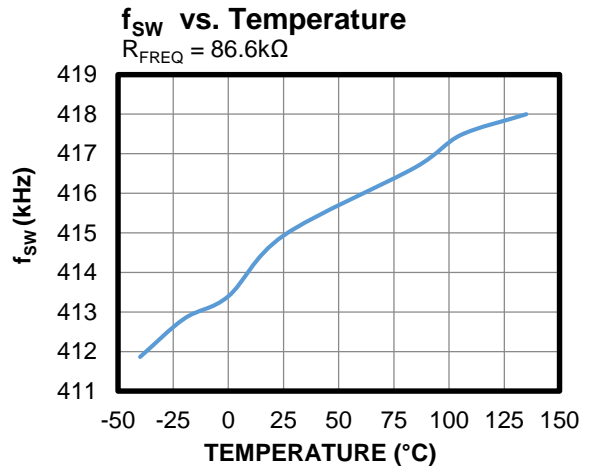
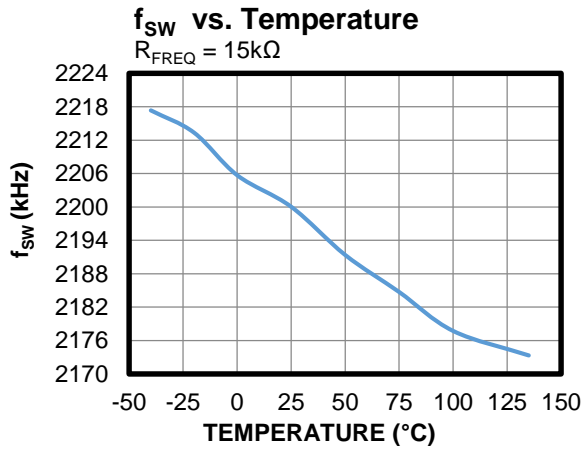

TYPICAL PERFORMANCE CHARACTERISTICS

V_{IN} = 12V, V_{OUT} = 5V, f_{SW} = 2.2MHz, L = 2.2μH, C_{OUT} = 22μF x 2, T_A = 25°C, unless otherwise noted.

Input Current vs. Load Current

R_{FB1} = 100kΩ, R_{FB2} = 19.1kΩ,
DCR = 22.1mΩ

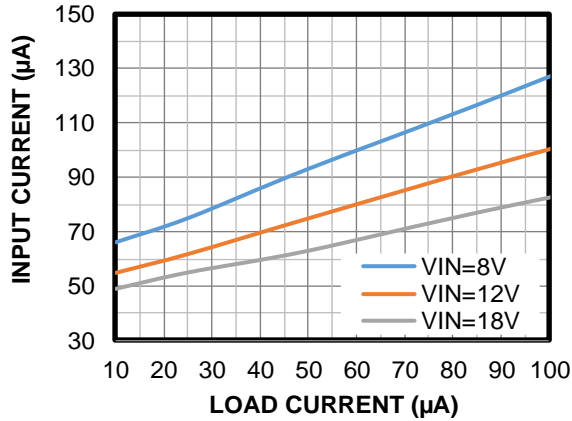

Efficiency vs. Load Current

R_{FB1} = 100kΩ, R_{FB2} = 19.1kΩ,
DCR = 22.1mΩ

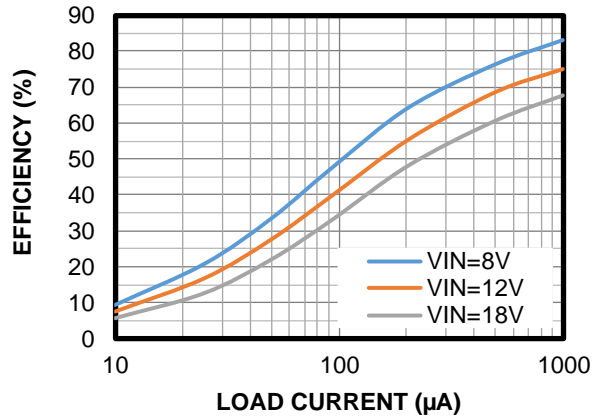

Efficiency vs. Load Current

DCR = 22.1mΩ

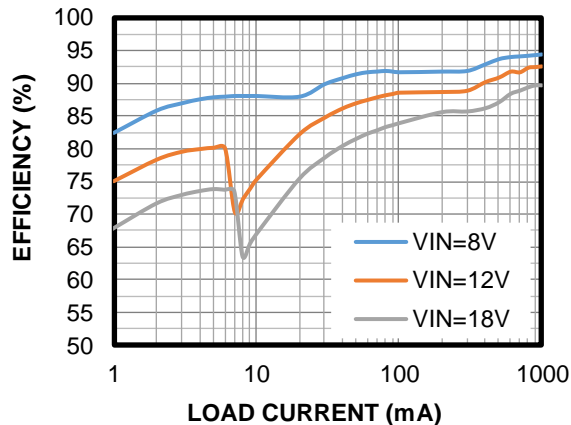

Efficiency vs. Load Current

DCR = 22.1mΩ

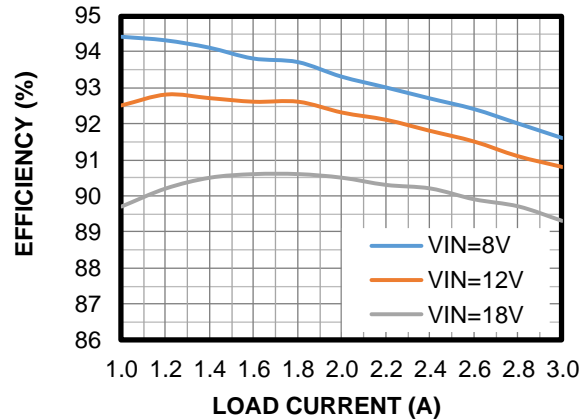

Input Current vs. Load Current

V_{OUT} = 3.3V, R_{FB1} = 100kΩ,
R_{FB2} = 31.6kΩ, DCR = 22.1mΩ

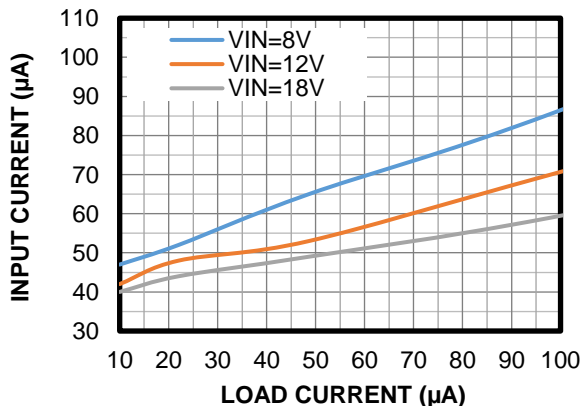

Efficiency vs. Load Current

V_{OUT} = 3.3V, R_{FB1} = 100kΩ, R_{FB2} = 31.6kΩ,
DCR = 22.1mΩ

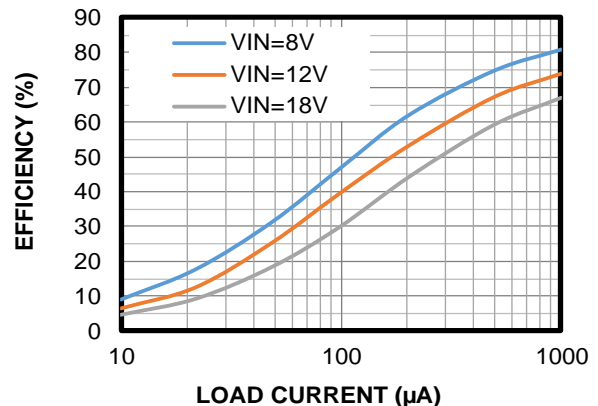

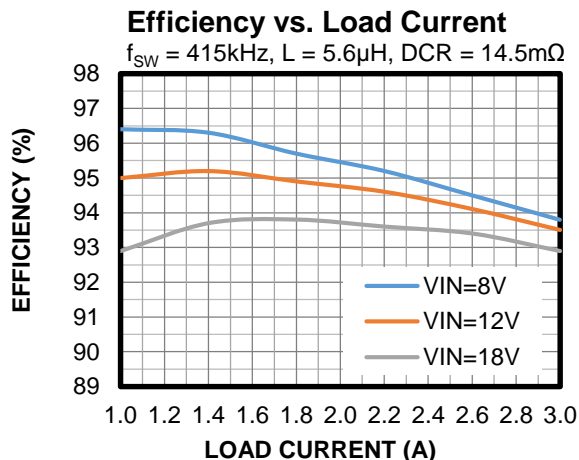
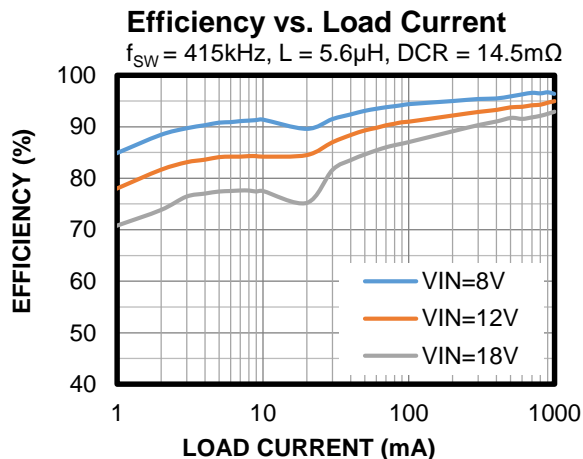
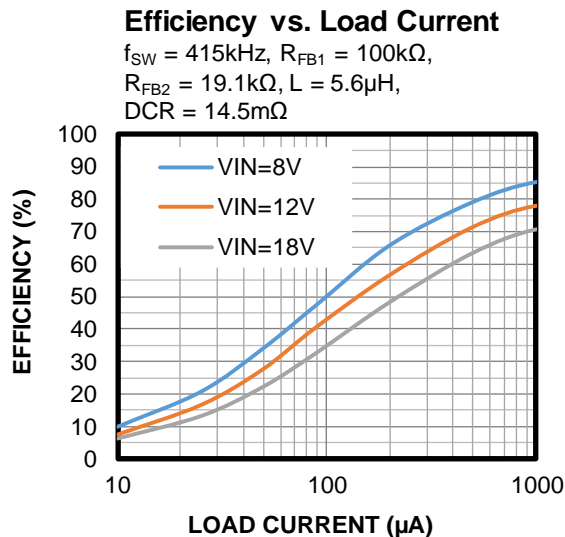
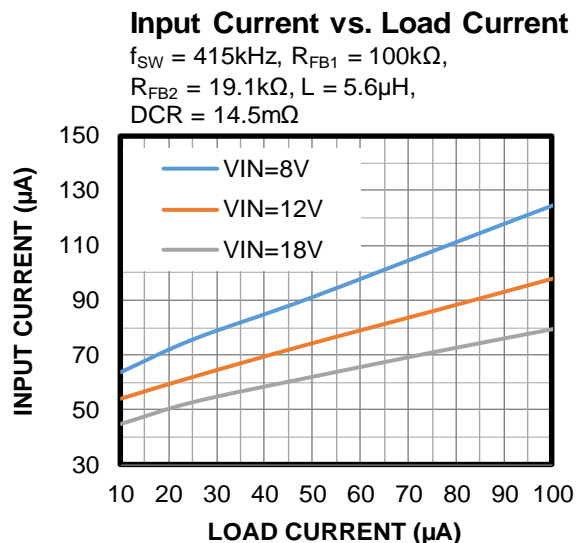
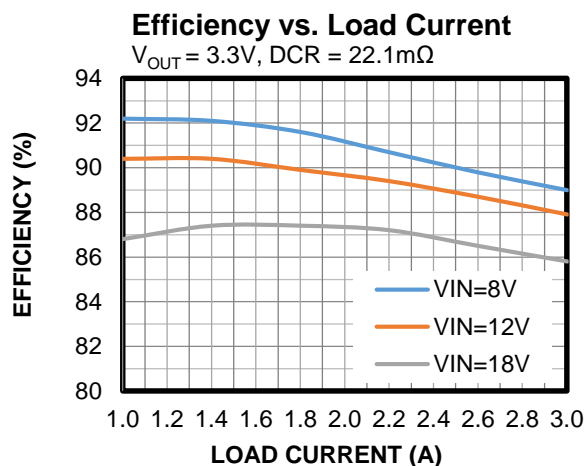
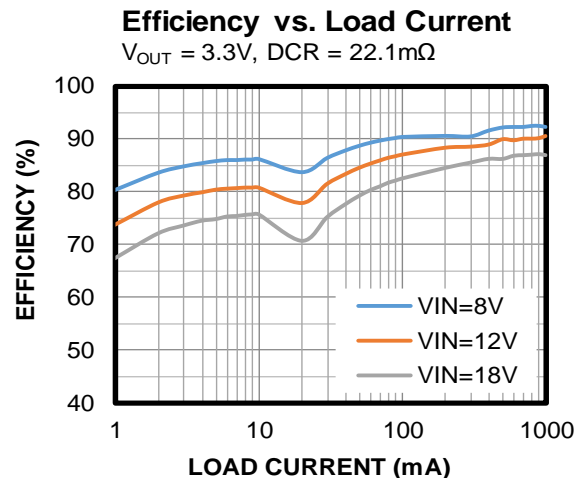
TYPICAL PERFORMANCE CHARACTERISTICS (continued)
 $V_{IN} = 12V$, $V_{OUT} = 5V$, $f_{SW} = 2.2MHz$, $L = 2.2\mu H$, $C_{OUT} = 22\mu F \times 2$, $T_A = 25^\circ C$, unless otherwise noted.

TYPICAL PERFORMANCE CHARACTERISTICS (continued)
 $V_{IN} = 12V$, $V_{OUT} = 5V$, $f_{SW} = 2.2MHz$, $L = 2.2\mu H$, $C_{OUT} = 22\mu F \times 2$, $T_A = 25^\circ C$, unless otherwise noted.

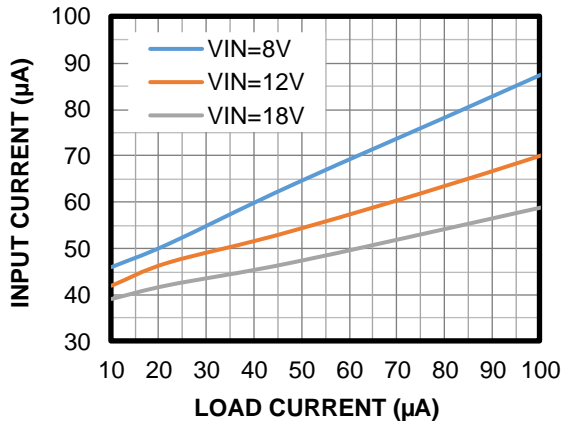
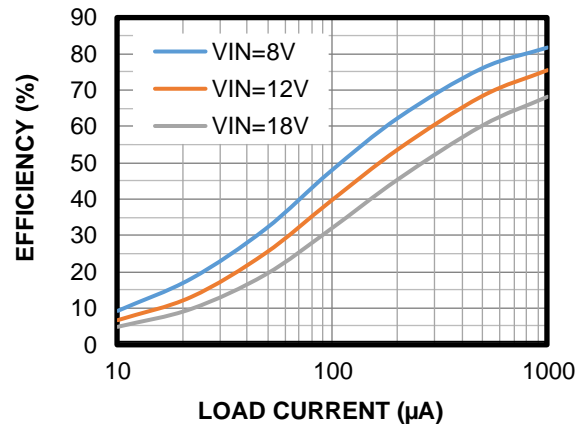
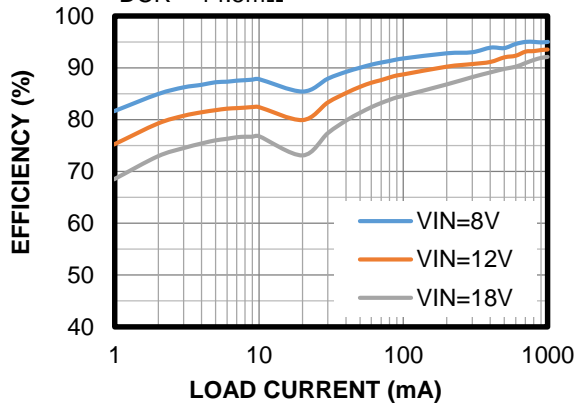
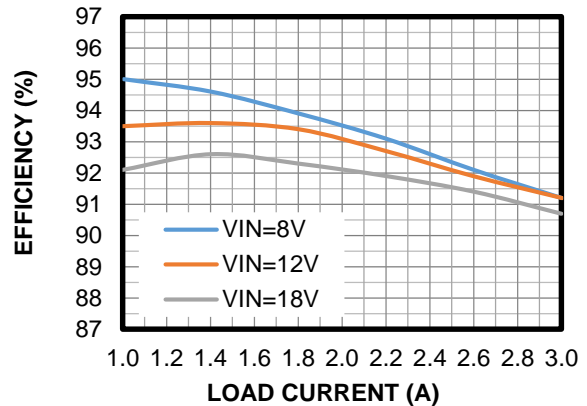
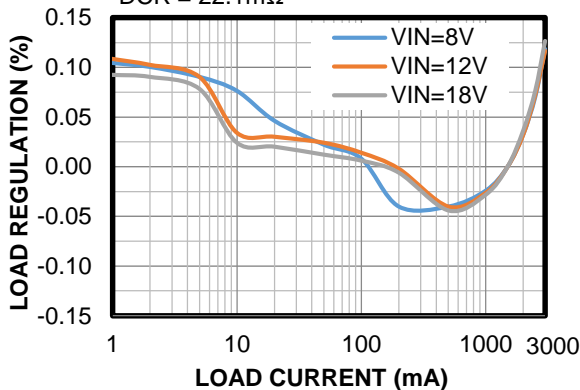
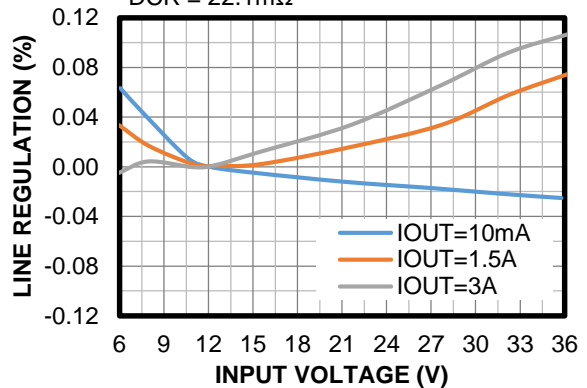
Input Current vs. Load Current
 $V_{OUT} = 3.3V$, $f_{SW} = 415kHz$, $R_{FB1} = 100k\Omega$,
 $R_{FB2} = 31.6k\Omega$, $L = 5.6\mu H$, $DCR = 14.5m\Omega$

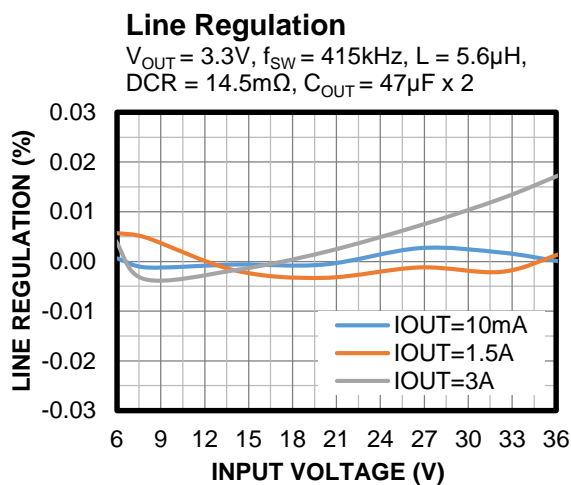
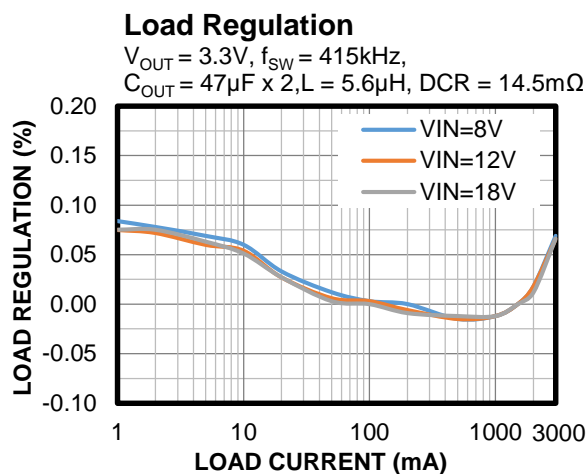
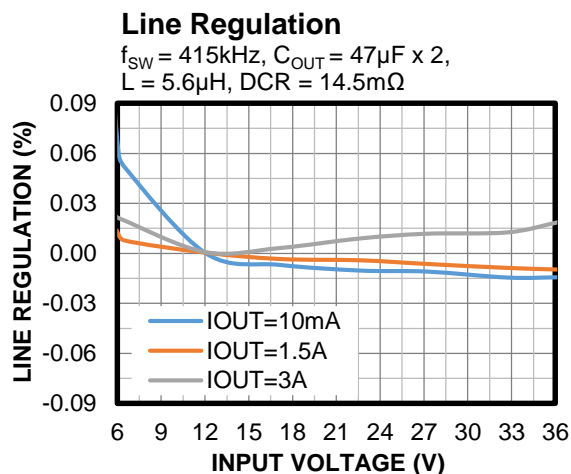
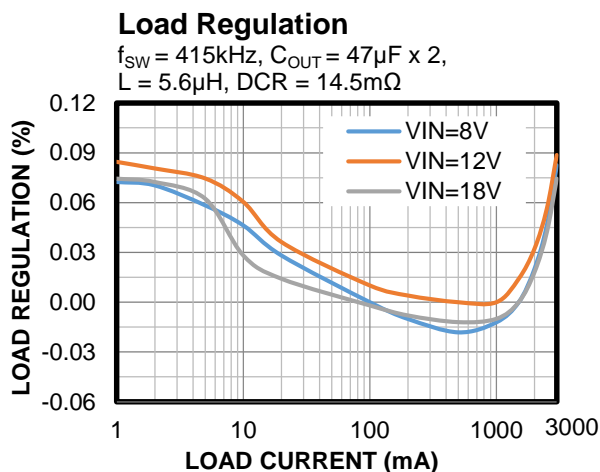
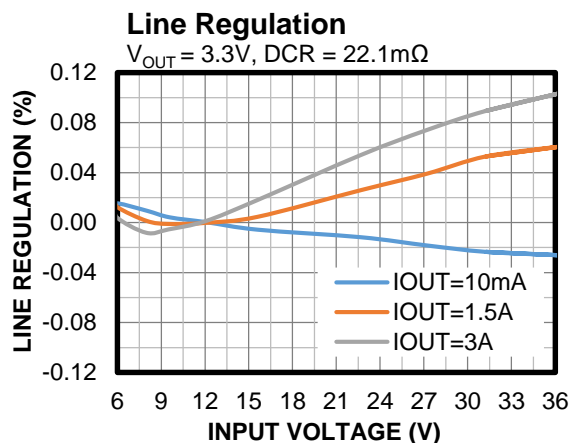
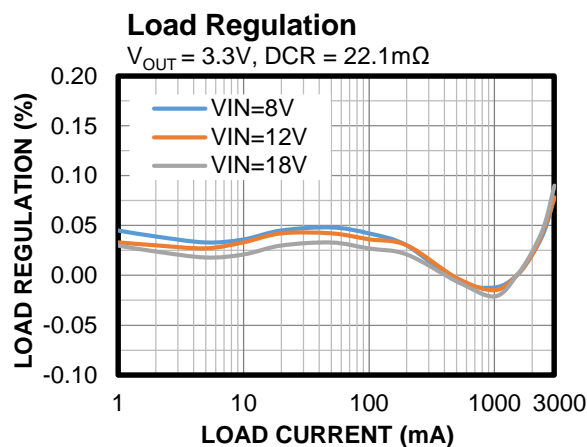
Efficiency vs. Load Current
 $V_{OUT} = 3.3V$, $f_{SW} = 415kHz$, $R_{FB1} = 100k\Omega$,
 $R_{FB2} = 31.6k\Omega$, $L = 5.6\mu H$, $DCR = 14.5m\Omega$

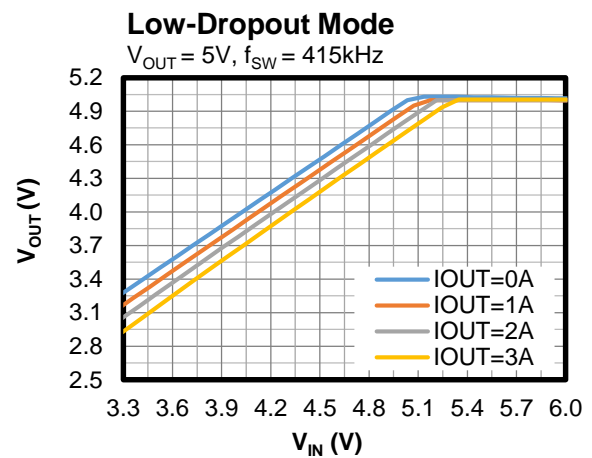
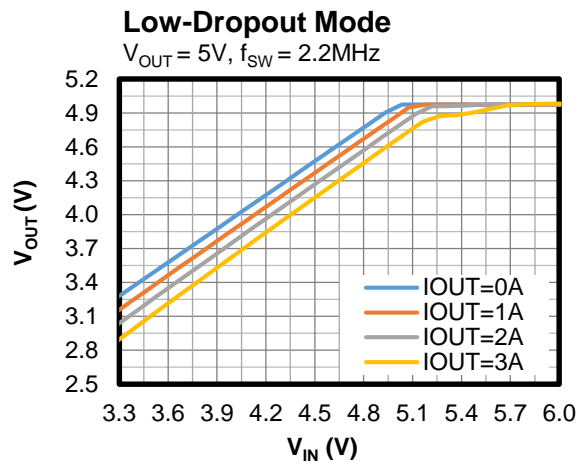
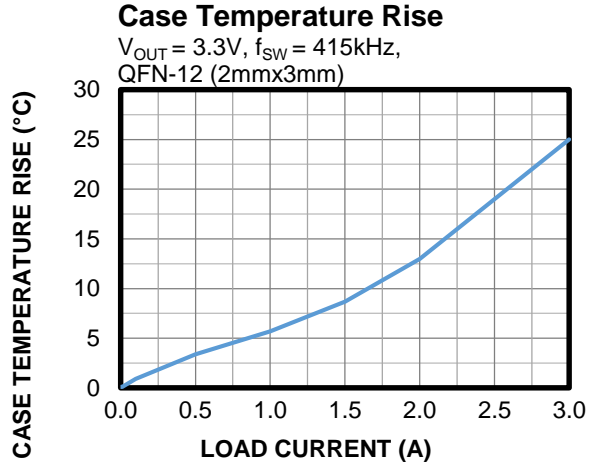
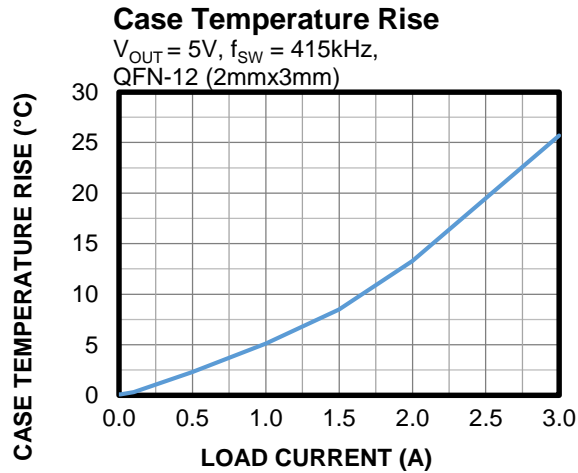
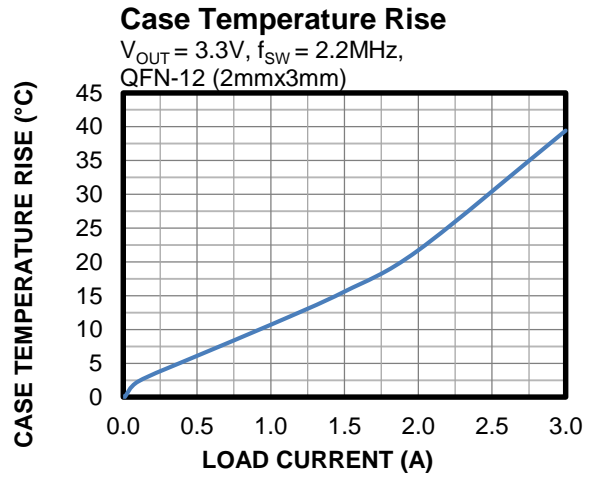
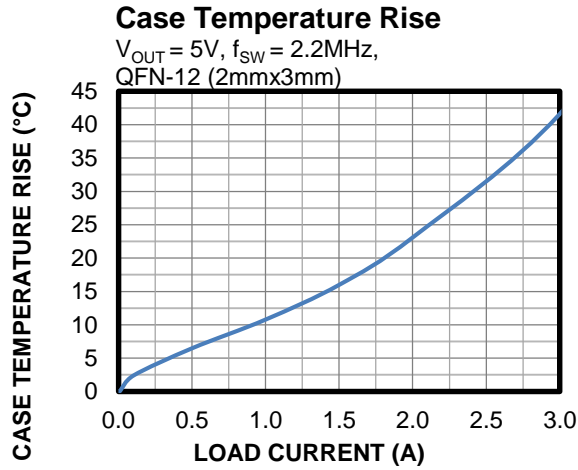
Efficiency vs. Load Current
 $V_{OUT} = 3.3V$, $f_{SW} = 415kHz$, $L = 5.6\mu H$,
 $DCR = 14.5m\Omega$

Efficiency vs. Load Current
 $V_{OUT} = 3.3V$, $f_{SW} = 415kHz$, $L = 5.6\mu H$,
 $DCR = 14.5m\Omega$

Load Regulation
 $DCR = 22.1m\Omega$

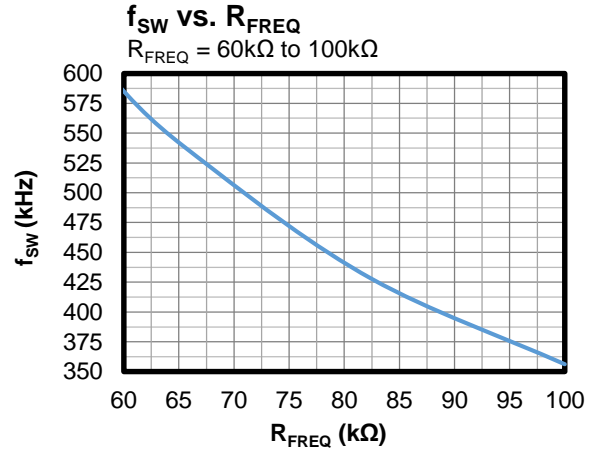
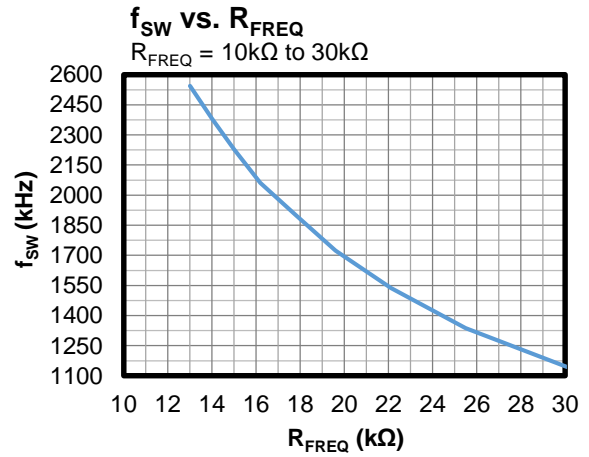
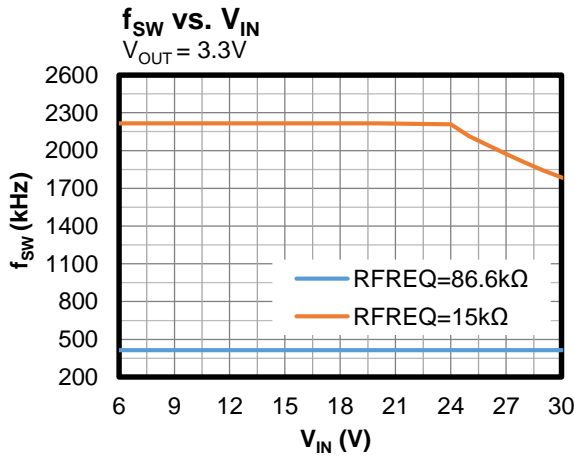
Line Regulation
 $DCR = 22.1m\Omega$

TYPICAL PERFORMANCE CHARACTERISTICS (continued)
 $V_{IN} = 12V$, $V_{OUT} = 5V$, $f_{SW} = 2.2MHz$, $L = 2.2\mu H$, $C_{OUT} = 22\mu F \times 2$, $T_A = 25^\circ C$, unless otherwise noted.

TYPICAL PERFORMANCE CHARACTERISTICS (continued)
 $V_{IN} = 12V$, $V_{OUT} = 5V$, $f_{SW} = 2.2MHz$, $L = 2.2\mu H$, $C_{OUT} = 22\mu F \times 2$, $T_A = 25^\circ C$, unless otherwise noted.

TYPICAL PERFORMANCE CHARACTERISTICS (continued)

V_{IN} = 12V, V_{OUT} = 5V, f_{SW} = 2.2MHz, L = 2.2μH, C_{OUT} = 22μF x 2, T_A = 25°C, unless otherwise noted.



TYPICAL PERFORMANCE CHARACTERISTICS (continued)

V_{IN} = 12V, V_{OUT} = 5V, f_{SW} = 2.2MHz, L = 2.2μH, C_{OUT} = 22μF x 2, T_A = 25°C, unless otherwise noted. ⁽¹²⁾

CISPR25 Class 5 Peak Conducted Emissions

150kHz to 108MHz

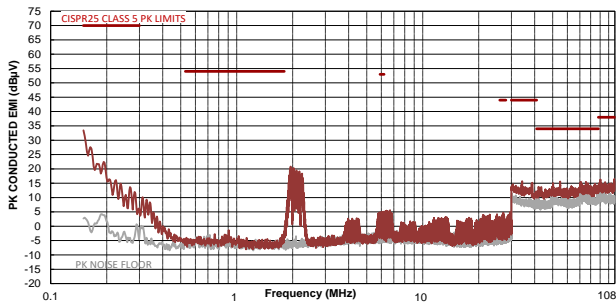

CISPR25 Class 5 Average Conducted Emissions

150kHz to 108MHz

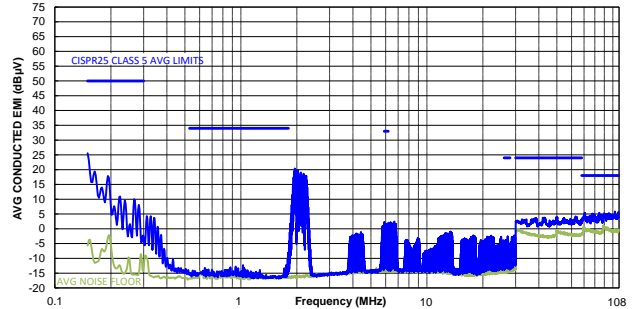

CISPR25 Class 5 Peak Radiated Emissions

150kHz to 30MHz

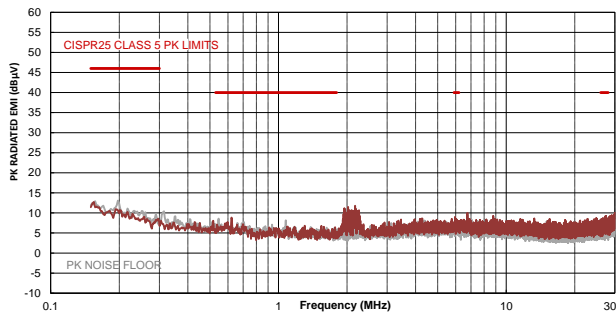

CISPR25 Class 5 Average Radiated Emissions

150kHz to 30MHz

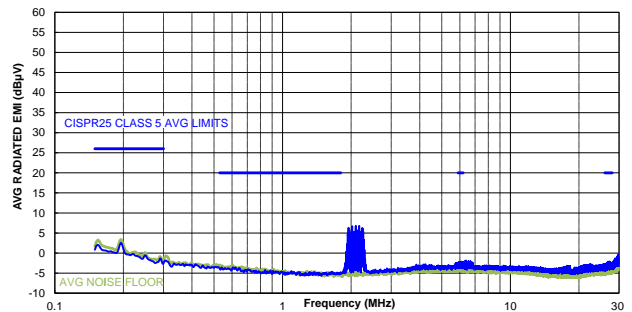

CISPR25 Class 5 Peak Radiated Emissions

Horizontal, 30MHz to 1GHz

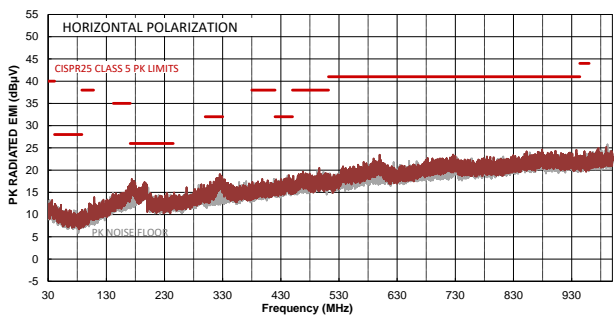

CISPR25 Class 5 Average Radiated Emissions

Horizontal, 30MHz to 1GHz

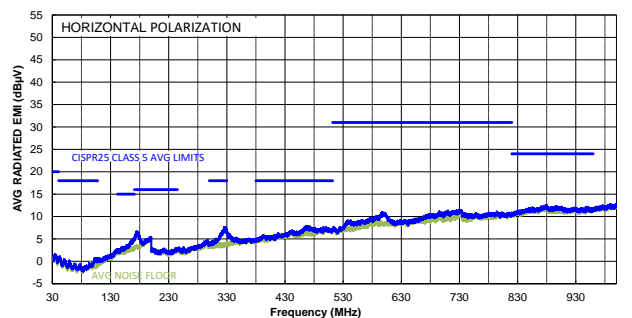

TYPICAL PERFORMANCE CHARACTERISTICS *(continued)*

V_{IN} = 12V, V_{OUT} = 5V, f_{SW} = 2.2MHz, L = 2.2μH, C_{OUT} = 22μF x 2, T_A = 25°C, unless otherwise noted. ⁽¹²⁾

CISPR25 Class 5 Peak Radiated Emissions

Vertical, 30MHz to 1GHz

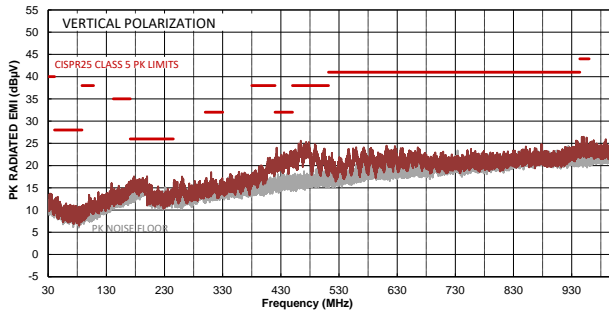

CISPR25 Class 5 Average Radiated Emissions

Vertical, 30MHz to 1GHz

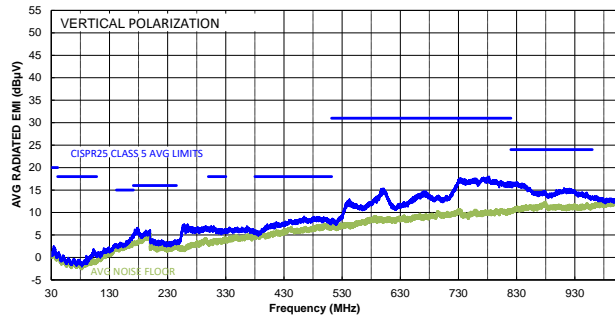

TYPICAL PERFORMANCE CHARACTERISTICS *(continued)*

V_{IN} = 12V, V_{OUT} = 5V, f_{SW} = 415kHz, L = 5.6μH, C_{OUT} = 47μF x 2, T_A = 25°C, unless otherwise noted. ⁽¹³⁾

CISPR25 Class 5 Peak Conducted Emissions

150kHz to 108MHz

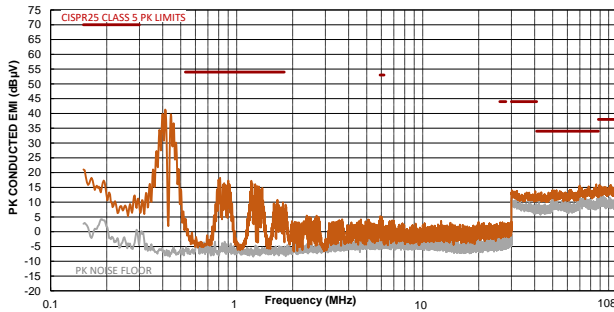

CISPR25 Class 5 Average Conducted Emissions

150kHz to 108MHz

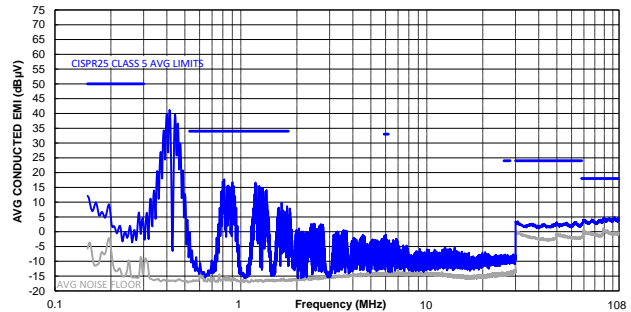

CISPR25 Class 5 Peak Radiated Emissions

150kHz to 30MHz

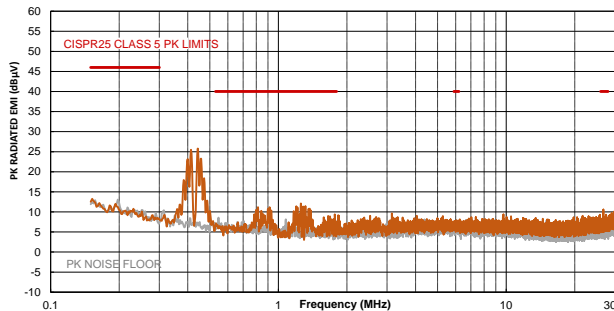

CISPR25 Class 5 Average Radiated Emissions

150kHz to 30MHz

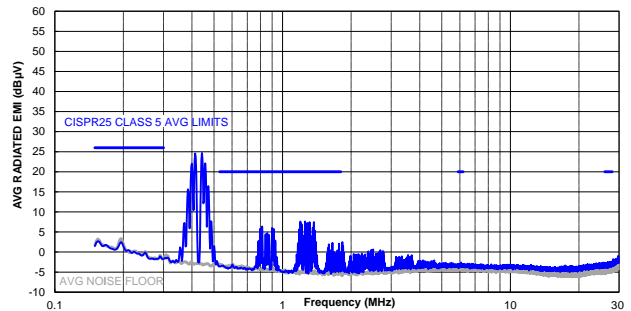

CISPR25 Class 5 Peak Radiated Emissions

Horizontal, 30MHz to 1GHz

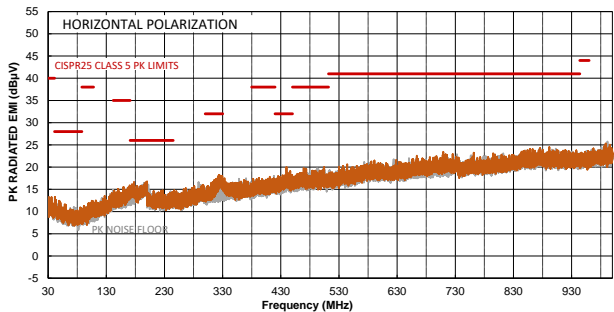

CISPR25 Class 5 Average Radiated Emissions

Horizontal, 30MHz to 1GHz

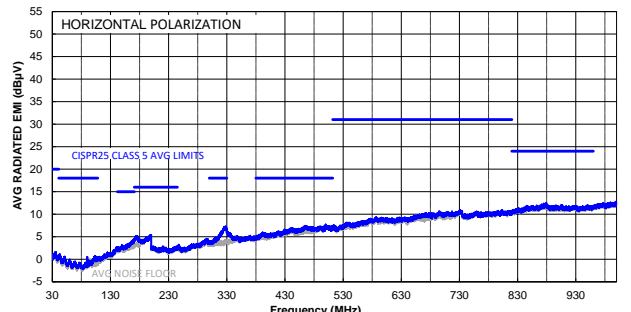

TYPICAL PERFORMANCE CHARACTERISTICS *(continued)*

V_{IN} = 12V, V_{OUT} = 5V, f_{SW} = 415kHz, L = 5.6μH, C_{OUT} = 47μF x 2, T_A = 25°C, unless otherwise noted. ⁽¹³⁾

CISPR25 Class 5 Peak Radiated Emissions

Vertical, 30MHz to 1GHz

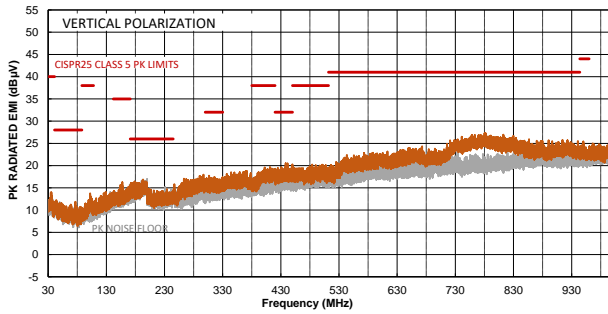

CISPR25 Class 5 Average Radiated Emissions

Vertical, 30MHz to 1GHz

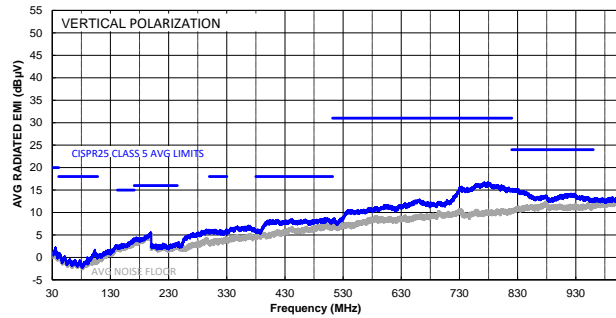

Note:

- 12) The EMC test results are based on Figure 16 on page 39.
- 13) The EMC test results are based on Figure 17 on page 40.

TYPICAL PERFORMANCE CHARACTERISTICS (continued)

V_{IN} = 12V, V_{OUT} = 5V, f_{SW} = 2.2MHz, L = 2.2μH, C_{OUT} = 22μF x 2, T_A = 25°C, unless otherwise noted.

Steady State

I_{OUT} = 0A

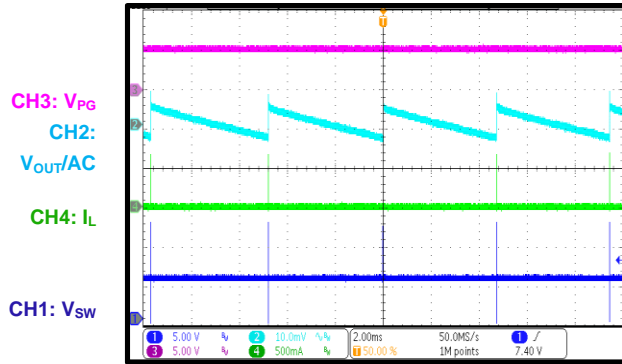

Steady State

I_{OUT} = 3A

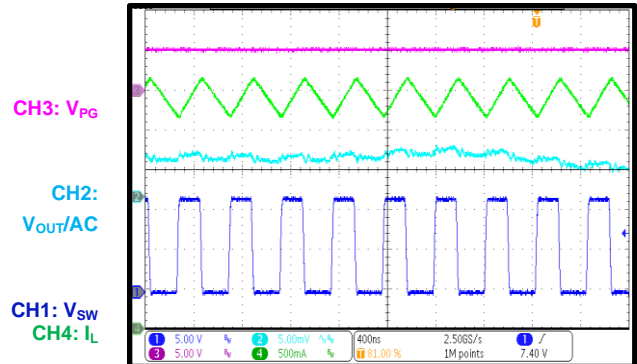

Start-Up through VIN

I_{OUT} = 0A

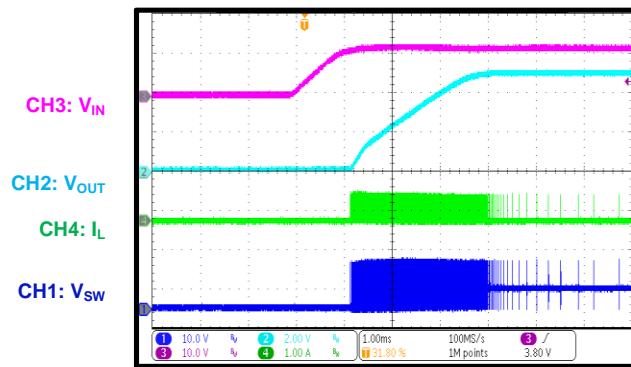

Start-Up through VIN

I_{OUT} = 3A

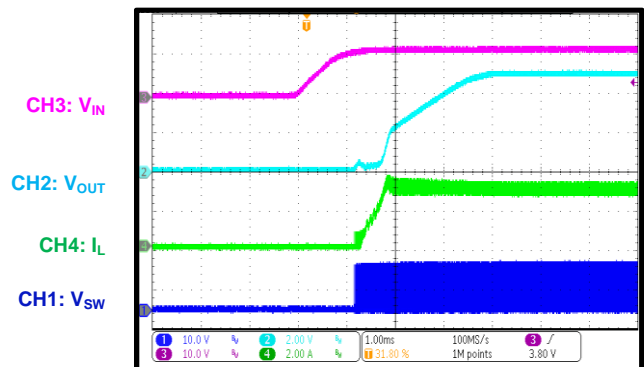

Shutdown through VIN

I_{OUT} = 0A

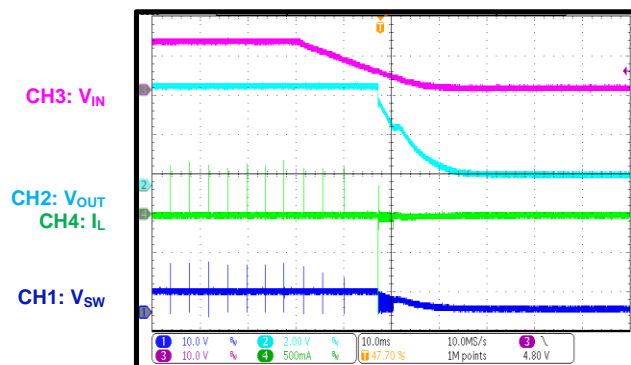

Shutdown through VIN

I_{OUT} = 3A

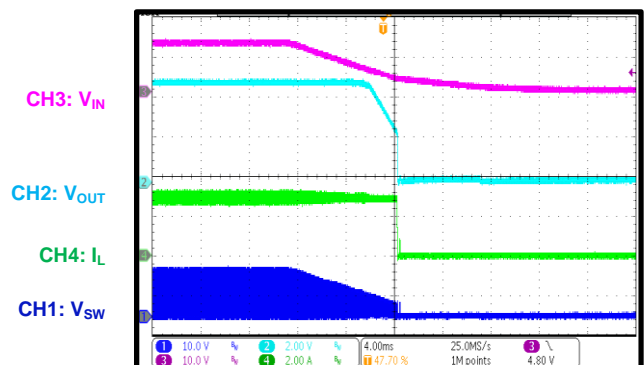

TYPICAL PERFORMANCE CHARACTERISTICS (continued)

V_{IN} = 12V, V_{OUT} = 5V, f_{SW} = 2.2MHz, L = 2.2μH, C_{OUT} = 22μF x 2, T_A = 25°C, unless otherwise noted.

Start-Up through EN
I_{OUT} = 0A

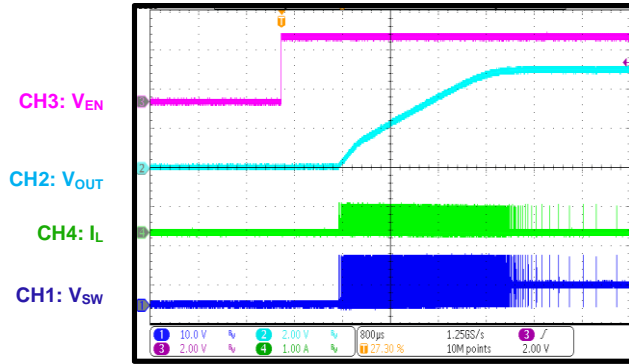

Start-Up through EN
I_{OUT} = 3A

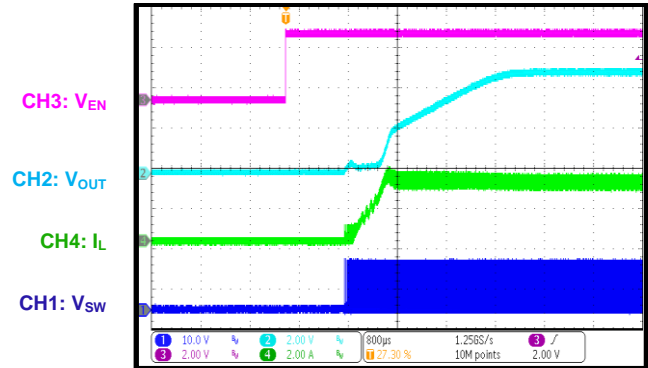

Shutdown through EN
I_{OUT} = 0A

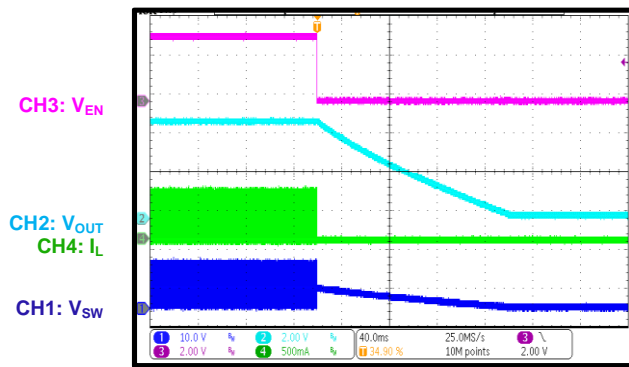

Shutdown through EN
I_{OUT} = 3A

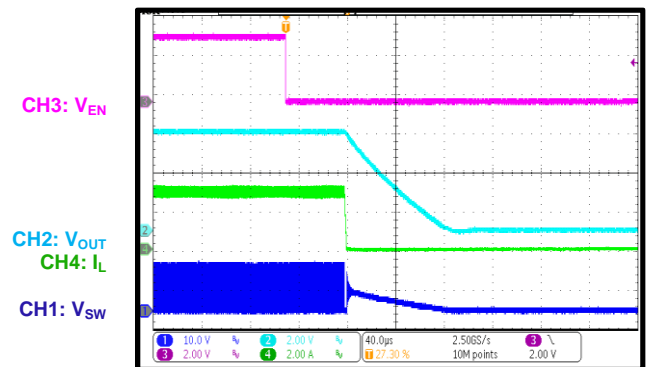

PG Start-Up through VIN
I_{OUT} = 0A

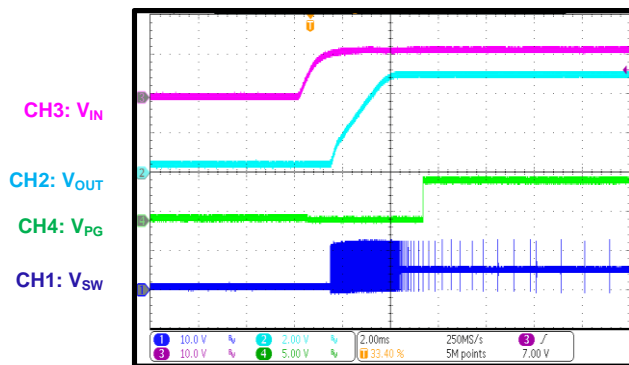

PG Start-Up through VIN
I_{OUT} = 3A

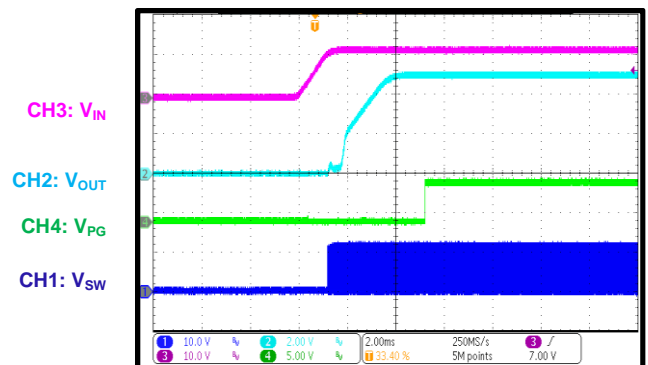

TYPICAL PERFORMANCE CHARACTERISTICS (continued)

V_{IN} = 12V, V_{OUT} = 5V, f_{SW} = 2.2MHz, L = 2.2μH, C_{OUT} = 22μF x 2, T_A = 25°C, unless otherwise noted.

PG Shutdown through VIN

I_{OUT} = 0A

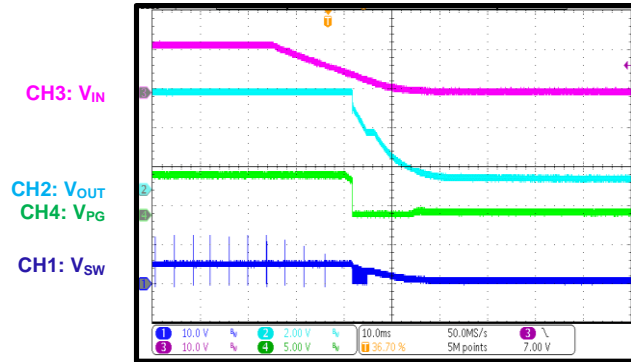

PG Shutdown through VIN

I_{OUT} = 3A

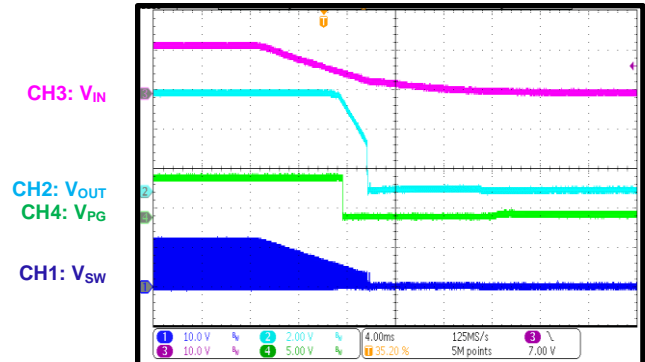

PG Start-Up through EN

I_{OUT} = 0A

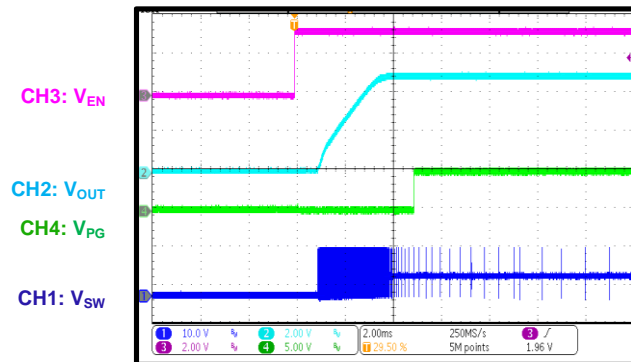

PG Start-Up through EN

I_{OUT} = 3A

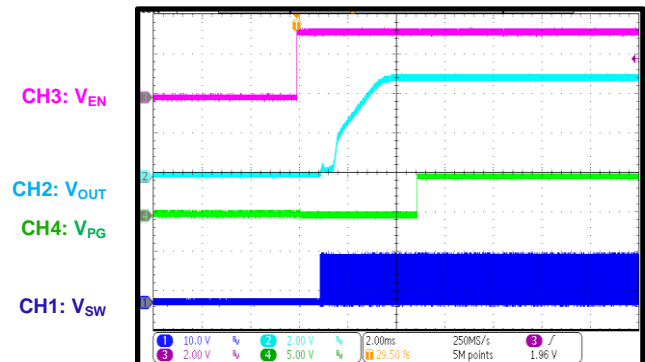

PG Shutdown through EN

I_{OUT} = 0A

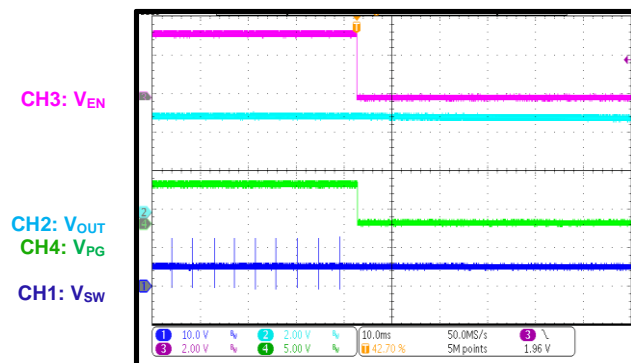

PG Shutdown through EN

I_{OUT} = 3A

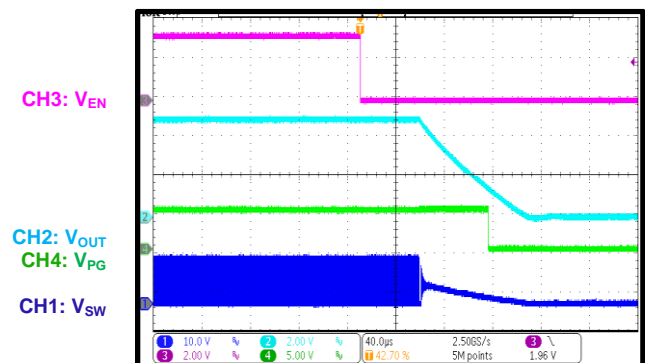

TYPICAL PERFORMANCE CHARACTERISTICS (continued)
 $V_{IN} = 12V$, $V_{OUT} = 5V$, $f_{SW} = 2.2MHz$, $L = 2.2\mu H$, $C_{OUT} = 22\mu F \times 2$, $T_A = 25^\circ C$, unless otherwise noted.

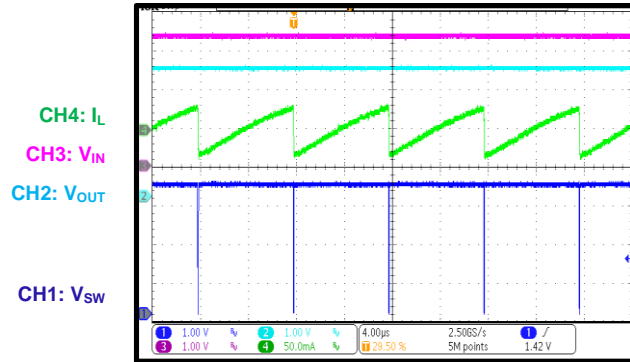
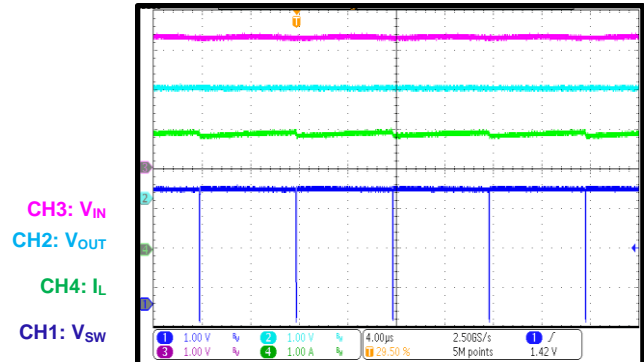
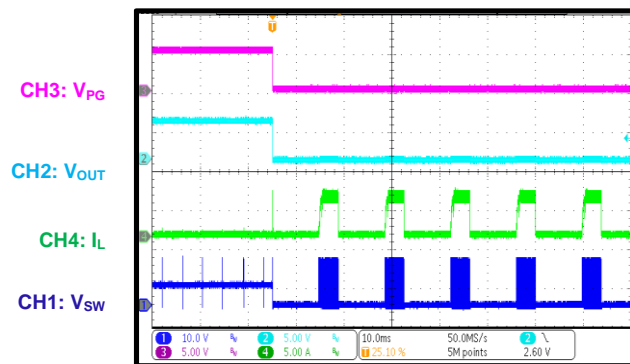
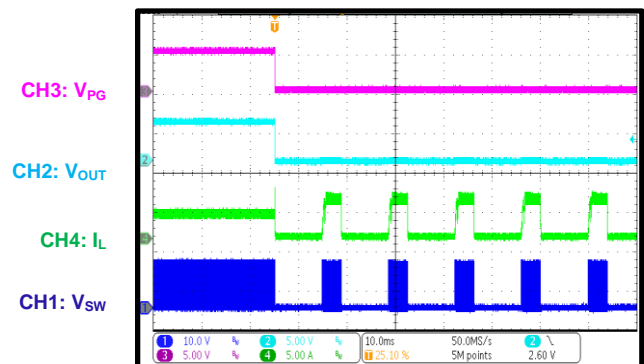
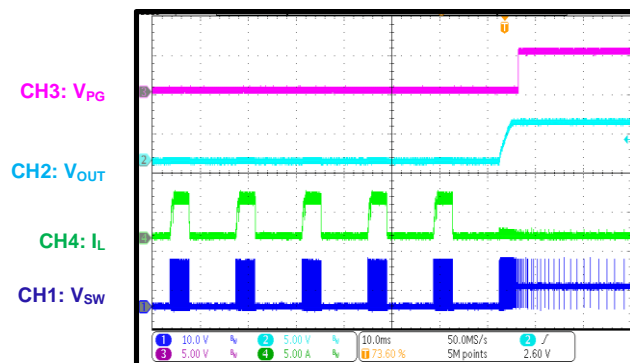
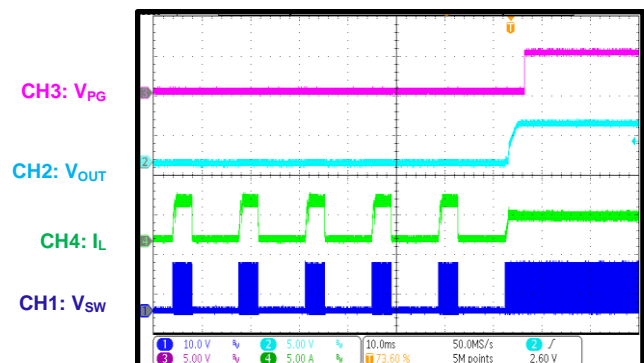
Low-Dropout Mode
 $I_{OUT} = 0A$, $V_{IN} = 3.3V$

Low-Dropout Mode
 $I_{OUT} = 3A$, $V_{IN} = 3.3V$

SCP Entry
 $I_{OUT} = 0A$

SCP Entry
 $I_{OUT} = 3A$

SCP Recovery
 $I_{OUT} = 0A$

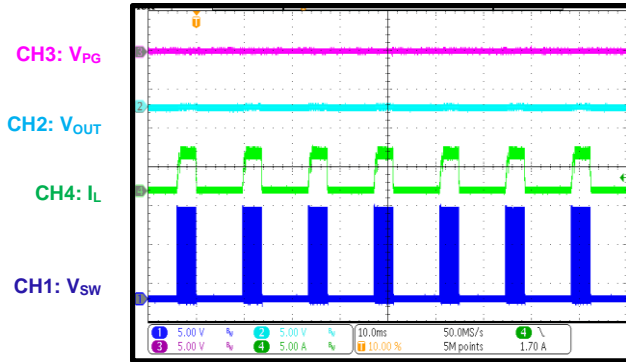
SCP Recovery
 $I_{OUT} = 3A$

TYPICAL PERFORMANCE CHARACTERISTICS (continued)

V_{IN} = 12V, V_{OUT} = 5V, f_{SW} = 2.2MHz, L = 2.2μH, C_{OUT} = 22μF x 2, T_A = 25°C, unless otherwise noted.

SCP Steady State

I_{OUT} = 0A



Load Transient

I_{OUT} = 1.5A to 3A, 1.6A/μs

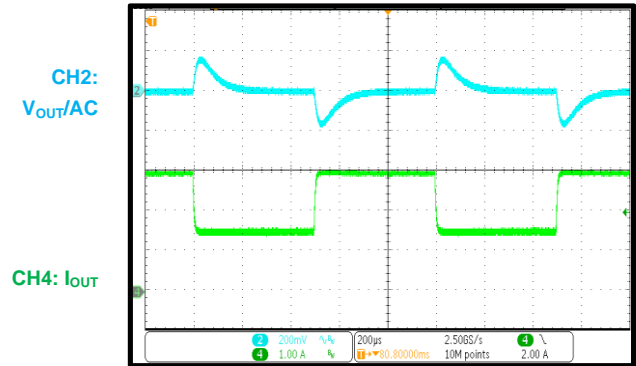

Load Dump

V_{IN} = 12V to 42V, I_{OUT} = 0A

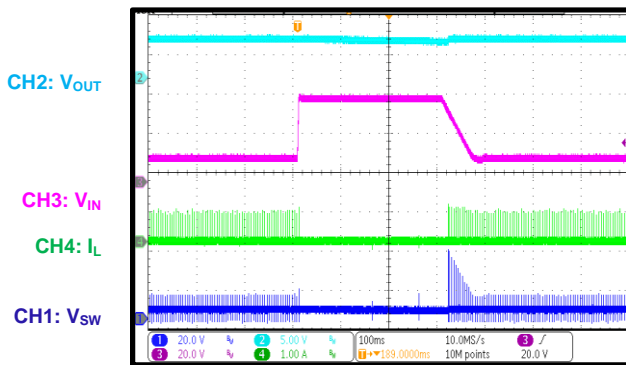

Load Dump

V_{IN} = 12V to 42V, I_{OUT} = 3A

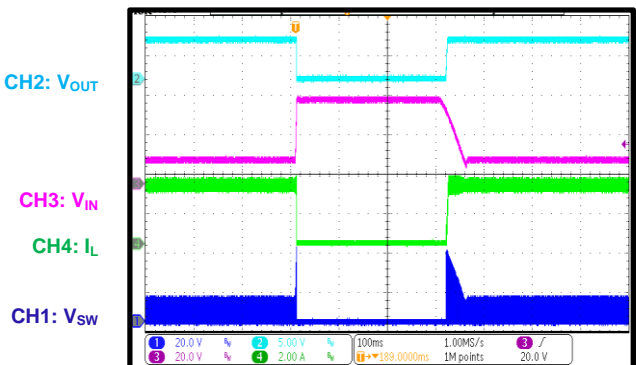

Cold Crank

V_{IN} = 12V to 3.3V to 6V, I_{OUT} = 0A

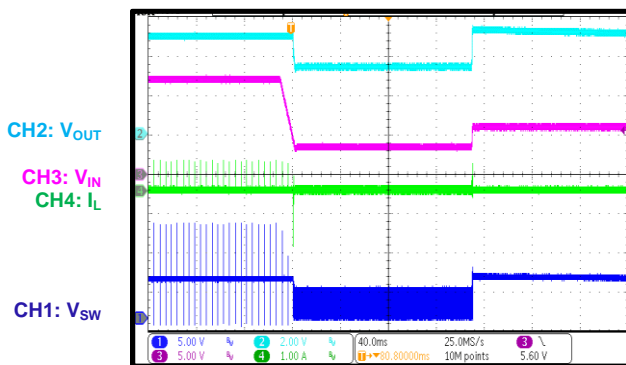

Cold Crank

V_{IN} = 12V to 3.3V to 6V, I_{OUT} = 3A

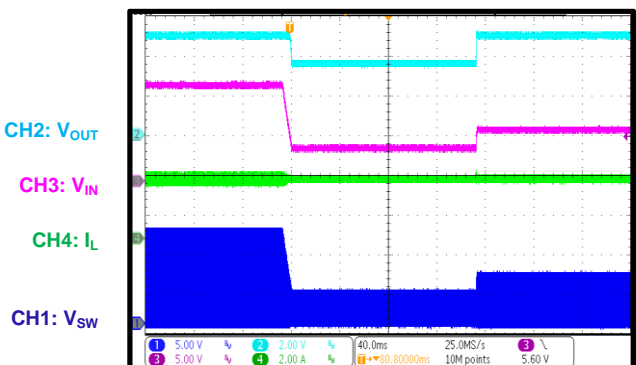

TYPICAL PERFORMANCE CHARACTERISTICS *(continued)*

V_{IN} = 12V, V_{OUT} = 5V, f_{SW} = 2.2MHz, L = 2.2μH, C_{OUT} = 22μF x 2, T_A = 25°C, unless otherwise noted.

V_{IN} Ramps Down and Up
V_{IN} = 6V to 0V, 0.5V/min, I_{OUT} = 0A

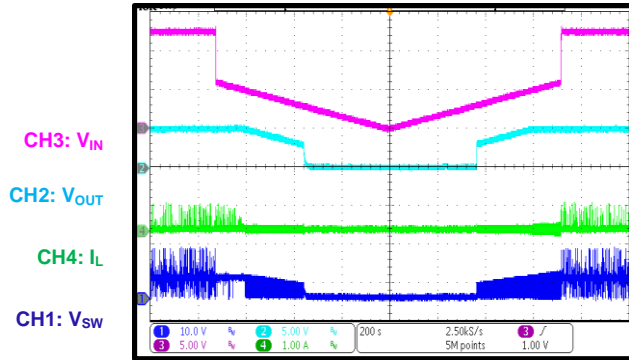

V_{IN} Ramps Down and Up
V_{IN} = 6V to 0V, 0.5V/min, I_{OUT} = 3A

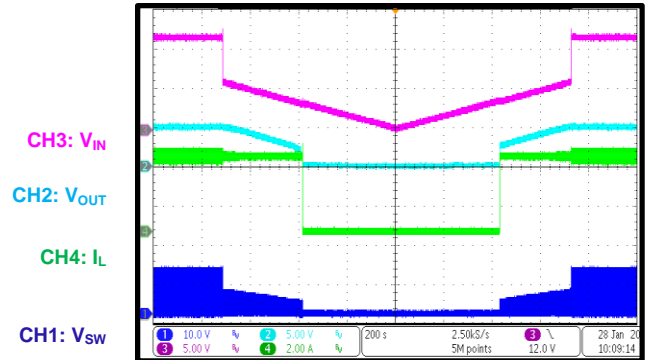

FUNCTIONAL BLOCK DIAGRAMS

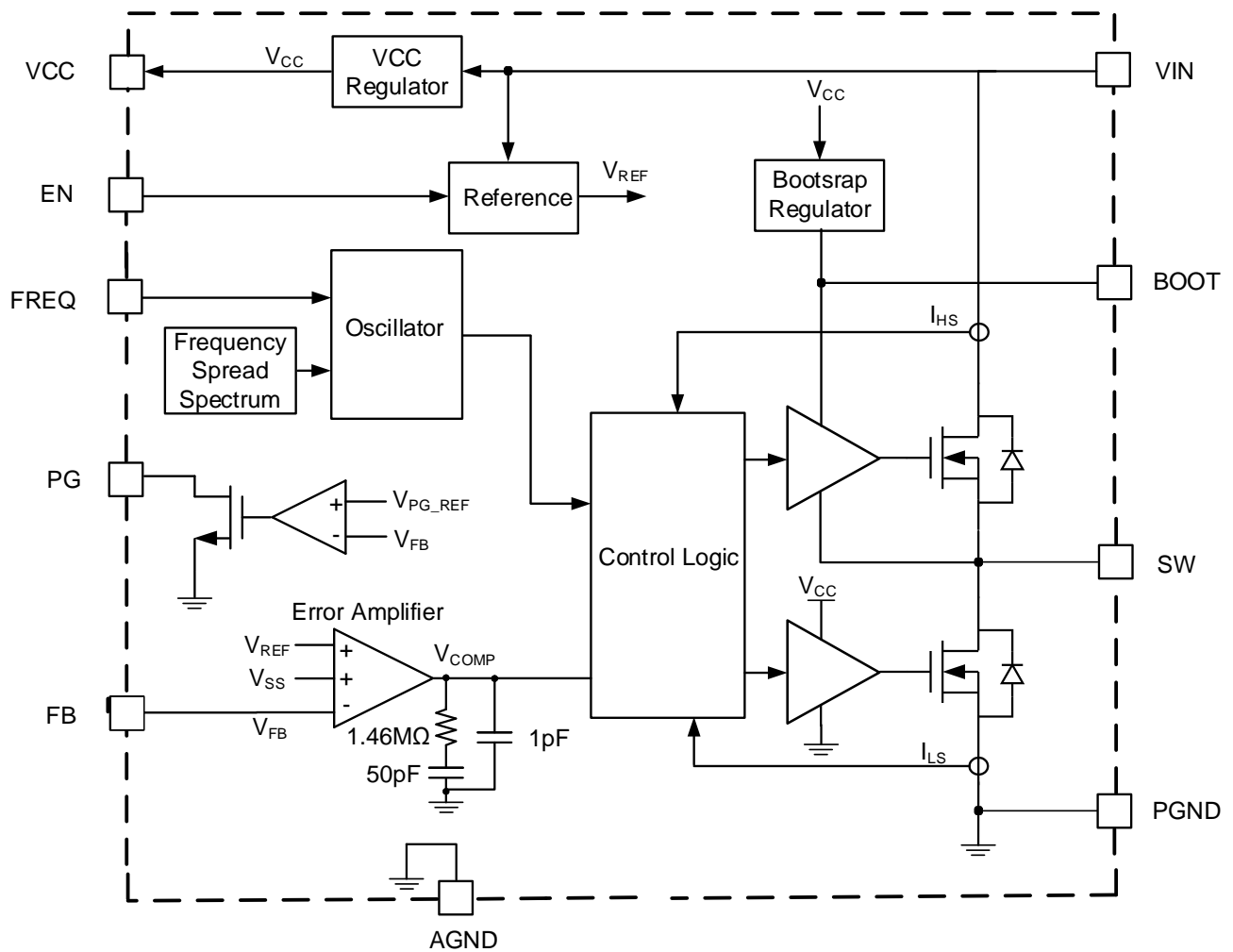

Figure 3: Functional Block Diagram (Adjustable Output)

FUNCTIONAL BLOCK DIAGRAMS (continued)

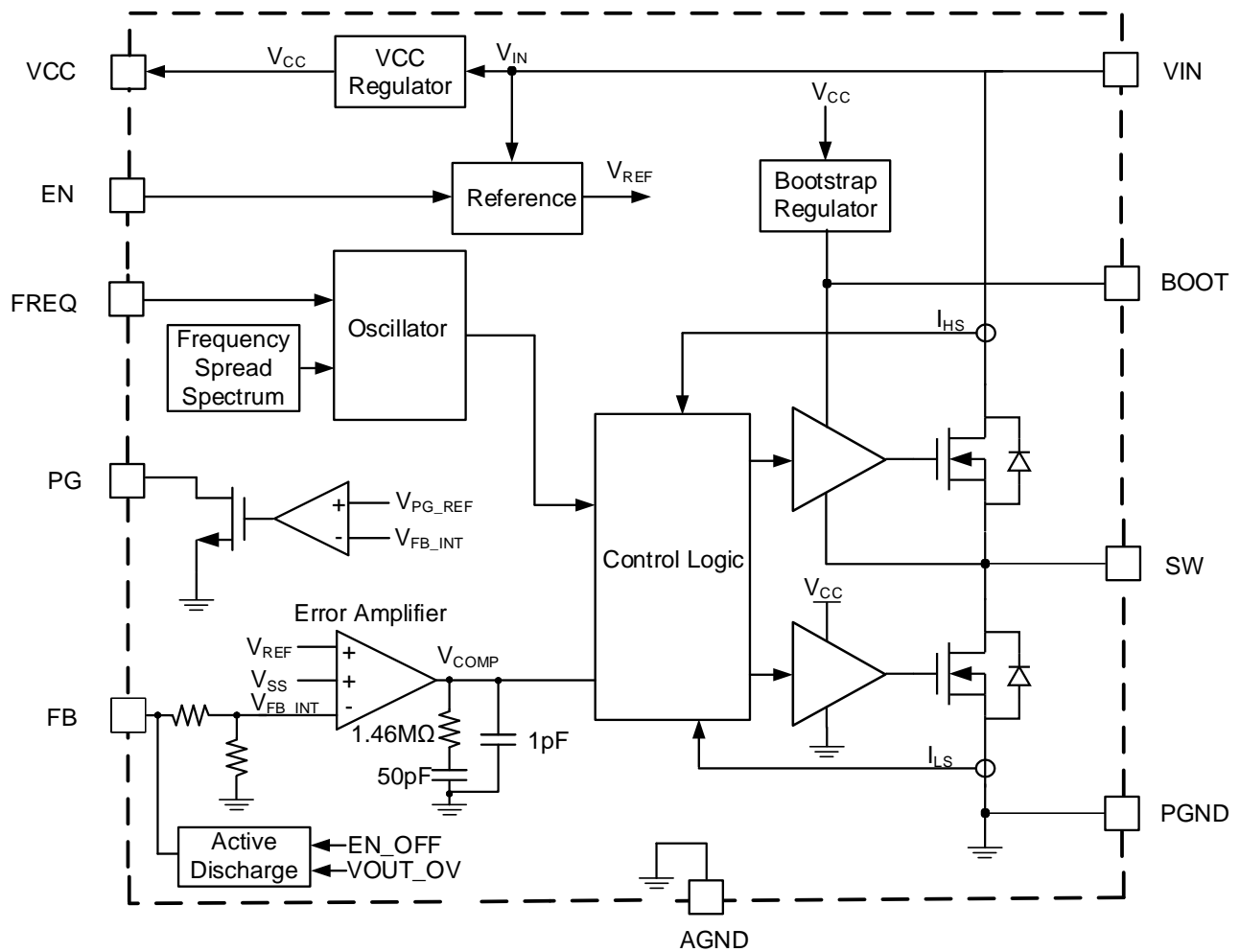

Figure 4: Functional Block Diagram (Fixed Output)

OPERATION

The MP4323 is a synchronous, step-down switching converter with integrated internal high-side and low-side power MOSFETs (HS-FET and LS-FET, respectively). It can achieve up to 3A of highly efficient output current (I_{OUT}) with peak current control mode.

The device features a wide input voltage (V_{IN}) range, 350kHz to 2.5MHz configurable switching frequency (f_{SW}), internal soft start (SS), and precise current limit. The MP4323's low quiescent current (I_Q) makes it well-suited for battery-powered applications.

Pulse-Width Modulation (PWM) Control

At moderate to high output currents, the MP4323 operates with fixed-frequency, peak current mode control to regulate the output voltage (V_{OUT}). A PWM cycle is initiated by the internal clock. At the rising edge of the clock, the HS-FET turns on and remains on until the control signal reaches the value set by the internal COMP voltage (V_{COMP}).

If the HS-FET is off, then the LS-FET turns on and remains on until the next cycle starts or until the inductor current (I_L) drops below the zero current detection (ZCD) threshold. The LS-FET remains off for at least the minimum off time (t_{OFF_MIN}) before the next cycle starts.

If the current in the HS-FET cannot reach the value set by V_{COMP} within one PWM period, then the HS-FET remains on, skipping a turn-off operation. The HS-FET is forced off until it reaches the value set by V_{COMP} , or once its maximum on time (t_{ON_MAX}) (7 μ s) is complete. This mode extends the duty cycle, which achieves low dropout while $V_{IN} \approx V_{OUT}$.

Light-Load Operation

The MP4323 operates in advanced asynchronous modulation (AAM) mode to optimize efficiency under light-load and no-load conditions.

If I_L approaches 0A under light-load conditions, then the part enters asynchronous operation. If the load is further decreased and V_{COMP} drops below the set value, then the part enters AAM mode (see Figure 5).

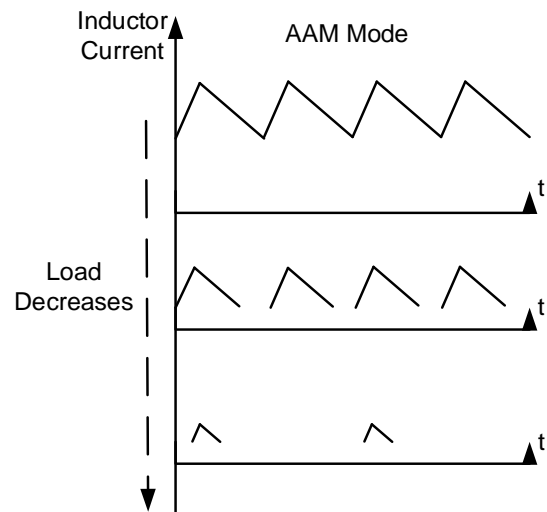

Figure 5: AAM Mode

In AAM mode, the internal clock is reset each time V_{COMP} exceeds the set value. The crossover time is used as a benchmark for the next clock. If the load increases and V_{COMP} exceeds the set value, then the device operates with a constant f_{SW} in either continuous conduction mode (CCM) or discontinuous conduction mode (DCM).

Error Amplifier (EA)

The error amplifier (EA) compares the feedback (FB) voltage (V_{FB}) with the internal reference voltage (V_{REF}) (0.8V), and outputs a current proportional to the difference between the two values. This current is then used to charge the compensation network to produce V_{COMP} . V_{COMP} provides the error that controls the power MOSFET's duty cycle.

During normal operation, the minimum V_{COMP} is clamped at 0.5V, and the maximum V_{COMP} is clamped at 2.5V. During shutdown, COMP is internally pulled down to AGND.

Frequency Spread Spectrum (FSS)

The MP4323 uses a 15kHz modulation frequency with a maximum 128-step triangular profile to spread the internal f_{SW} across a 20% ($\pm 10\%$) window. The steps vary with the set f_{SW} to ensure that the exact steps cycle by cycle (see Figure 6 on page 30).

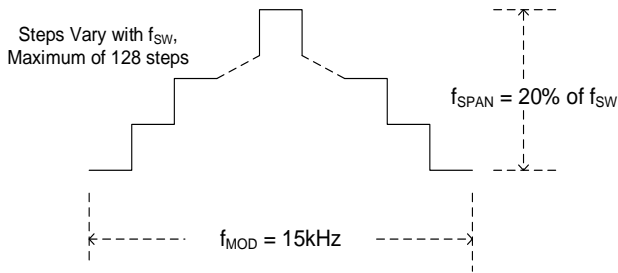

Figure 6: Frequency Spread Spectrum

Sidebands are created by modulating f_{SW} via the triangle modulation waveform. The emission power of the fundamental f_{SW} and its harmonics are reduced. This significantly reduces peak EMI noise.

Soft Start (SS)

Soft start (SS) is implemented to prevent V_{OUT} from overshooting during start-up. The soft-start time (t_{SS}) is fixed internally.

Once an SS is initiated, the soft-start voltage (V_{SS}) rises from 0V to 1.2V according to the internal slew rate. If V_{SS} drops below the internal V_{REF} (0.8V), then V_{SS} takes over and the EA uses V_{SS} as its reference. If V_{SS} exceeds V_{REF} , then the EA uses V_{REF} as its reference.

During start-up through EN, the first pulse occurs after about 830 μ s. V_{CC} is regulated, the internal bias is charged, and the compensation network is charged. Then V_{OUT} ramps up and reaches its set value after 2.9ms. SS is complete after 1.5ms. PG is also be pulled high after a 70 μ s delay.

Pre-Biased Start-Up

If V_{FB} exceeds V_{SS} during start-up, this means that the output has a pre-biased voltage. Both

the HS-FET and LS-FET remain off until V_{SS} exceeds V_{FB} .

Thermal Shutdown

Thermal shutdown prevents the device from operating at exceedingly high temperatures. If the die temperature exceeds the thermal shutdown threshold (about 175°C), then the device shuts down. Once the temperature drops below 155°C, the device initiates an SS to resume normal operation.

Start-Up and Shutdown

If both V_{IN} and V_{EN} exceeds their respective thresholds, then the IC starts up. The reference block starts up first to generate a stable V_{REF} and reference currents. Then the internal regulator turns on to provide a stable supply for the remaining circuitries.

Once the internal supply rail is up, then the internal circuits being normal operation. If the BOOT pin does not reach its refresh rising threshold (about 2.5V), then the LS-FET turns on to charge BOOT. The HS-FET remains off during this charging period. Once an SS is imitated, V_{OUT} starts to ramp up slowly until it reaches its target voltage. V_{OUT} should reach its target voltage within 5ms.

Three events can shut down the chip: EN goes low, V_{IN} drops below its UVLO threshold, and thermal shutdown. During shutdown, the signaling path is blocked to avoid any fault triggering. Then V_{COMP} is pulled down, and the HS-FET turns off.

APPLICATION INFORMATION

Selecting the Input Capacitor (C_{IN})

The step-down converter has a discontinuous input current (I_{IN}), and requires a capacitor to supply AC current to the converter while maintaining the DC V_{IN}. Use low-ESR capacitors for the best performance. Ceramic capacitors with X5R or X7R dielectrics are recommended due to their low ESR and small temperature coefficients.

For most applications, a 4.7μF to 10μF is sufficient. It is strongly recommended to use an additional lower-value capacitor (e.g. 0.1μF) with a small package size (0603) to absorb high-frequency switching noise. Place the smaller capacitor as close to the VIN and AGND pins as possible.

Since the input capacitor (C_{IN}) absorbs the input switching current, it requires an adequate ripple current rating. The RMS current in C_{IN} (I_{CIN}) can be estimated with Equation (1):

$$I_{CIN} = I_{LOAD} \times \sqrt{\frac{V_{OUT}}{V_{IN}} \times \left(1 - \frac{V_{OUT}}{V_{IN}}\right)} \quad (1)$$

The worst-case condition occurs at V_{IN} = 2 × V_{OUT}, which can be calculated with Equation (2):

$$I_{CIN} = \frac{I_{LOAD}}{2} \quad (2)$$

For simplification, choose an input capacitor with an RMS current rating greater than half of the maximum load current (I_{LOAD_MAX}). C_{IN} can be electrolytic, tantalum, or ceramic. When using electrolytic or tantalum capacitors, add a small, high-quality ceramic capacitor (e.g. 0.1μF) as close to the IC as possible. When using ceramic capacitors, ensure that they have enough capacitance to provide a sufficient charge to prevent excessive voltage ripple at the input. The input voltage ripple (ΔV_{IN}) caused by the capacitance can be estimated with Equation (3):

$$\Delta V_{IN} = \frac{I_{LOAD}}{f_{SW} \times C_{IN}} \times \frac{V_{OUT}}{V_{IN}} \times \left(1 - \frac{V_{OUT}}{V_{IN}}\right) \quad (3)$$

V_{IN} Over-Voltage Protection (OVP)

The MP4323 stops switching once V_{IN} exceeds its over-voltage protection (OVP) rising threshold (37.5V). The device resumes normal regulation once V_{IN} drops below the over-voltage falling threshold (36.5V).

Floating Driver and Bootstrap (BOOT) Charging

It is recommended to choose a BOOT capacitor (C_{BOOT}) between 0.1μF to 1μF.

It is not recommended to place a resistor (R_{BOOT}) in series with the C_{BOOT}, unless there is a strict EMI requirement. R_{BOOT} reduces EMI and voltage stress at high input voltages; however, it also generates additional power consumption and reduces efficiency. If necessary, choose R_{BOOT} to be below 4Ω.

The voltage between BOOT and SW (V_{BOOT}) is regulated to about 5V by the dedicated internal BOOT regulator. If V_{BOOT} drops below its regulated value, then a P-channel MOSFET pass transistor connected between VCC and BOOT turns on to C_{BOOT}. The external circuit should provide enough voltage headroom to facilitate charging. If the high-side MOSFET (HS-FET) is on and V_{BOOT} exceeds the VCC voltage (V_{CC}), then C_{BOOT} is not charged.

At higher duty cycles, the time available to charge C_{BOOT} is shorter. C_{BOOT} may not be charged sufficiently since the external circuit does not have sufficient voltage or time to charge C_{BOOT}. External circuitry can ensure that V_{BOOT} remains within its normal operating range.

If V_{BOOT} exceeds its UVLO threshold, then the HS-FET turns off, and the LS-FET turns on. The LS-FET has a t_{OFF_MIN} to refresh V_{BOOT} via f_{SW}.

Setting the Switching Frequency (f_{sw})

f_{sw} can be set via an external resistor (R_{FREQ}) connected from the FREQ pin to AGND (see the f_{sw} vs. R_{FREQ} curves on page 16).

Connect R_{FREQ} between the FREQ and GND pins, placed as close to the IC as possible.

Table 1 shows the resistor values for different f_{SW} .

Table 1: Resistor Values for Different f_{SW}

R _{FREQ} (kΩ)	f _{SW} (kHz)	R _{FREQ} (kΩ)	f _{SW} (kHz)
100	355	30.1	1150
93.1	385	26.1	1300
86.6	415	22.6	1450
80.6	450	20.5	1600
75	480	19.6	1750
68.1	520	17.8	1900
59	600	16.2	2050
51.1	700	15	2200
40.2	850	14.3	2350
34.8	1000	13.3	2500

It is not possible to have both a f_{SW} and a high V_{IN} due to the HS-FET's t_{MIN_ON} . The MP4323 control loop sets the maximum possible f_{SW} as the set frequency automatically. This also reduces power loss. V_{OUT} is regulated by varying the duration of the HS-FET's off time (t_{OFF}), which reduces f_{SW} .

The device is guaranteed to adhere to the HS-FET's minimum on time. This means that the device operates at the target f_{SW} for as long as possible, and f_{SW} changes only while the device is operating at a high V_{IN} . For more details, see the f_{SW} vs. V_{IN} curve on page 16, where $R_{FREQ} = 15k\Omega$ and $V_{OUT} = 3.3V$.

Selecting the Internal VCC Capacitor

It is recommended to use a $1\mu F$ VCC capacitor (C_{VCC}). Most of the internal circuitry is powered by the internal 5V VCC regulator. This regulator uses the VIN pin as its input to operate across the entire V_{IN} range. If V_{IN} exceeds 5V, then VCC is in full regulation. If V_{IN} drops below 5V, then the VCC output degrades.

Setting the Feedback (FB) Voltage

The external resistor divider ($R_5 + R_6$) sets the output voltage (see Figure 7).

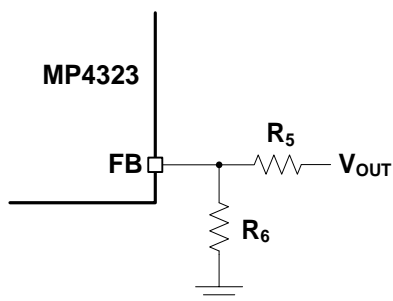

Figure 7: FB Network with Adjustable Output

R_6 can be calculated with Equation (4):

$$R_6 = \frac{R_5}{\frac{V_{OUT}}{0.8V} - 1} \quad (4)$$

With a fixed output, the FB resistor divider is integrated internally. This means that the FB pin must be connected to the output directly to set V_{OUT} . The following fixed outputs can be selected: 1V, 1.8V, 2.5V, 3V, 3.3V, 3.8V, and 5V (see Figure 8).

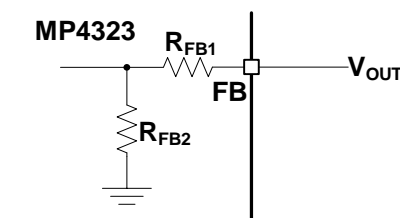

Figure 8: FB Network with Fixed Output

Table 2 shows the resistor values for different V_{OUT} .

Table 2: Resistor Values for Different V_{OUT}

V _{OUT} (V)	R _{FB1} (kΩ)	R _{FB2} (kΩ)
1	64	256
1.8	320	256
2.5	544	256
3	704	256
3.3	800	256
3.8	960	256
5	1344	256

Power Good (PG) Indication

The PG resistor (R_7) should have a resistance of about $100k\Omega$. The MP4323 includes an open-drain power good (PG) output that indicates whether V_{OUT} is within its nominal range.

Connect PG to a logic high power source (e.g. 3.3V) via a pull-up resistor. If V_{OUT} is within 94.5% to 105.5% of the nominal voltage, then PS is pulled high. PG goes low if V_{OUT} exceeds 107% or drops below 93% of the nominal voltage, then PG is pulled low. Float PG if not used.

Enable (EN) and Under-Voltage Lockout (UVLO) Protection

The enable (EN) pin is a digital control pin that turns the converter on and off.

Enable via External Logic High/Low Signal

If the EN voltage (V_{EN}) reaches 0.7V, then the

bottom gate (BG) turns on once V_{IN} exceeds 2.7V. BG turns on to provides an accurate V_{REF} for the V_{EN} threshold. Pull EN above 1.02V to turns the converter on; pull EN below 0.85V to turn it off. There is no internal pull-up or pull-down resistor connected to the EN pin. Do not float EN. An external pull-up or pull-down resistor is required if the control signal cannot give an accurate high or low logic.

Configurable V_{IN} UVLO Protection

The MP4323 has an internal, fixed UVLO threshold. The rising threshold is 3.65V, and the falling threshold is about 2.9V. For applications requiring a higher UVLO point, place an external resistor divider between the V_{IN} and EN pins (see Figure 9).

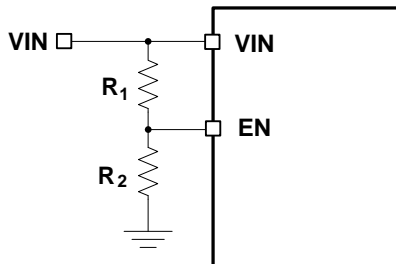

Figure 9: Configurable UVLO via the EN Divider

The UVLO rising threshold can be calculated with Equation (5):

$$V_{IN_UVLO_RISING} = \left(1 + \frac{R_1}{R_2}\right) \times V_{EN_RISING} \quad (5)$$

Where V_{EN_RISING} is 1.02V.

The UVLO falling threshold can be calculated with Equation (6):

$$V_{IN_UVLO_FALLING} = \left(1 + \frac{R_1}{R_2}\right) \times V_{EN_FALLING} \quad (6)$$

Where $V_{EN_FALLING}$ is 0.85V.

If EN is not used to turn the IC on and off, connect EN to a high voltage source (e.g. V_{IN}) to turn the device on by default.

Selecting the Inductor and the Output Capacitors

The inductance (L_1) can be estimated with Equation (7):

$$L_1 = \frac{V_{OUT}}{f_{SW} \times \Delta I_L} \times \left(1 - \frac{V_{OUT}}{V_{IN}}\right) \quad (7)$$

Where ΔI_L is the peak-to-peak inductor ripple current.

For most applications, a 1 μ H to 10 μ H inductor with a DC current rating that exceeds at least 25% of I_{LOAD_MAX} is recommended. For higher efficiency, choose an inductor with a lower DC resistance. A larger-value inductor results in less ripple current and a lower output ripple voltage (ΔV_{OUT}); however, a larger-value inductor has a larger physical size, higher series resistance, and lower saturation current. A good rule to determine the inductance is to have the inductor ripple current be approximately 30% of the I_{LOAD_MAX} .

The peak inductor current (I_{L_PEAK}) can be calculated with Equation (8)

$$I_{L_PEAK} = I_{LOAD} + \frac{V_{OUT}}{2f_{SW} \times L} \times \left(1 - \frac{V_{OUT}}{V_{IN}}\right) \quad (8)$$

Choose an inductor that does not saturate under I_{L_PEAK} .

ΔV_{OUT} can be estimated with Equation (9):

$$\Delta V_{OUT} = \frac{V_{OUT}}{f_{SW} \times L} \times \left(1 - \frac{V_{OUT}}{V_{IN}}\right) \times \left(R_{ESR} + \frac{1}{8f_{SW} \times C_{OUT}}\right) \quad (9)$$

Where L is the inductance.

The output capacitor (C_{OUT}) maintains the DC V_{OUT} . Use ceramic, tantalum, or low-ESR electrolytic capacitors for C_{OUT} . For the best results, use low-ESR capacitors to keep ΔV_{OUT} low.

When using ceramic capacitors, the capacitance dominates the impedance at f_{SW} and causes the majority of ΔV_{OUT} . For simplification, ΔV_{OUT} can be calculated with Equation (10):

$$\Delta V_{OUT} = \frac{V_{OUT}}{8 \times f_{SW}^2 \times L \times C_{OUT}} \times \left(1 - \frac{V_{OUT}}{V_{IN}}\right) \quad (10)$$

For tantalum or electrolytic capacitors, the ESR dominates the impedance at f_{SW} . For simplification, ΔV_{OUT} can be estimated with Equation (11):

$$\Delta V_{OUT} = \frac{V_{OUT}}{f_{SW} \times L} \times \left(1 - \frac{V_{OUT}}{V_{IN}}\right) \times R_{ESR} \quad (11)$$

When selecting C_{OUT} , consider the allowed V_{OUT} overshoot if the load is suddenly removed. In this scenario, energy stored in the inductor is transferred to C_{OUT} , causing its voltage to rise. To achieve optimal overshoot relative to the regulated voltage, C_{OUT} can be estimated with Equation (12):

$$C_{OUT} = \frac{I_{OUT}^2 \times L}{V_{OUT}^2 \times \left(\left(V_{OUTMAX} / V_{OUT}\right)^2 - 1\right)} \quad (12)$$

Where V_{OUTMAX} / V_{OUT} is the allowable maximum overshoot.

After calculating the capacitance that meets both the ripple requirement and overshoot requirement, choose the larger of the two capacitances for application.

The characteristics of C_{OUT} also affect the stability of the regulation system. The MP4323 can be optimized for a wide range of capacitance and ESR values.

Peak and Valley Current Limits

Both the HS-FET and LS-FET feature cycle-by-cycle current limiting. If I_L reaches the high-side peak current limit (I_{LIMIT_HS}) (typically 5.8A) while the HS-FET is on, then the HS-FET turns off to prevent the current from rising further.

If the LS-FET is on, the next clock's rising edge is held until I_L drops below the low-side valley

current limit (I_{LIMIT_LS}) (typically 4.4A). I_L drops to a sufficiently low value once the HS-FET turns on again. This prevents current runaway if an overload condition or short-circuit occurs.

Short-Circuit Protection (SCP)

If the output is shorted to ground and V_{OUT} drops below 70% of its nominal voltage, then the part shuts down and discharges V_{SS} . Once V_{SS} is fully discharged, the device initiates an SS to resume normal operation. This hiccup process is repeated until the fault is removed.

Output Over-Voltage Protection (OVP) and Discharge

The MP4323 stops switching if V_{OUT} exceeds 130% of its nominal voltage, then the MP4323 shuts down. An internal 75Ω discharge path between the FB to AGND pins discharges V_{OUT} . This discharge path is only active with a fixed output. The part resumes normal operation once V_{OUT} drops below 125% of its nominal voltage, and the discharge path is disabled.

For a fixed output, the V_{OUT} discharge path also activates if a shutdown through EN occurs while V_{CC} exceeds its UVLO rising threshold. Once V_{CC} drops below its UVLO falling threshold, the discharge path is deactivated.

Design Guide

Table 3 shows the design guide index.

Table 3: Design Guide Index

Pin #	Pin Name	Component	Design Guide Index
1, 11	PGND	-	GND connection (PGND, pin 1, pin 6, and pin 11)
2, 10	VIN	C1A, C1B, C1C, C1D	Selecting the input capacitors (VIN, pin 2, and pin 10)
3	BOOT	R4, C4	Floating driver and bootstrap charging (BOOT, pin 3)
4	FREQ	R3	Setting f_{sw} (FREQ, pin 4)
5	VCC	C3	Setting the internal V_{CC} (VCC, pin 5)
6	AGND	-	GND connection (AGND, pin 1, pin 6, and pin 11)
7	FB	R5, R6	Feedback (FB, pin 7)
8	PG	R7	Power good indication (PG, pin 8)
9	EN	R1, R2	Enable (EN) and configuring UVLO (EN, pin 9)
12	SW	L1, C2A, C2B	Selecting the inductor and the output capacitor (SW, pin 12)

PCB Layout Guidelines ⁽¹⁴⁾

Efficient PCB layout is critical for stable operation, especially the placement of the input capacitor. A 4-layer layout is recommended to improve thermal performance. For the best results, refer to Figure 10 and follow the guidelines below:

1. Place the symmetric input capacitors as close to the VIN and AGND as possible.
2. Use a large ground plane to connect PGND.
3. If the bottom layer is a ground plane, place multiple vias near PGND.
4. Connect the high-current paths (AGND and VIN) using short, direct, and wide traces.
5. To minimize high-frequency noise, place the ceramic input capacitors, especially the small-sized (0603) input bypass capacitor, as close to VIN and PGND as possible.

6. Make the connection between the input capacitor and VIN as short and wide as possible.
7. Place the VCC capacitor as close to VCC and AGND as possible.
8. Route SW and BOOT away from sensitive analog areas, such as FB.
9. Place the feedback resistors as close to the IC as possible to make the FB trace as short as possible.
10. Use multiple vias to connect the power planes to the internal layers.

Note:

14) The recommended PCB layout is based on the typical application circuit in Figure 11 on page 36.

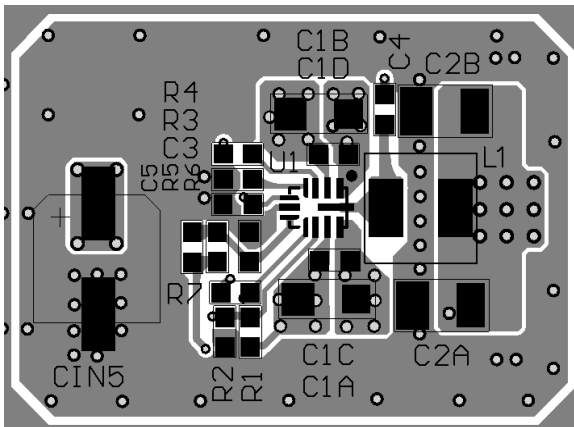
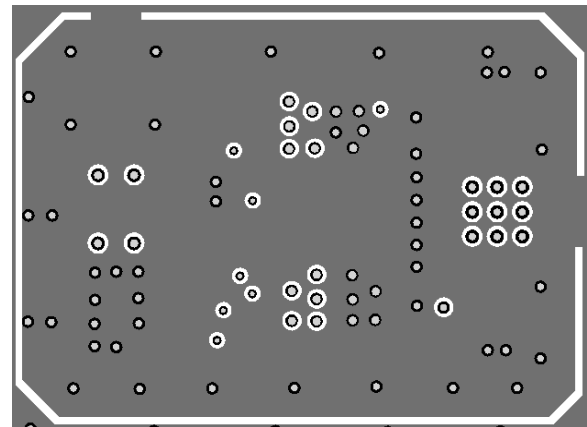
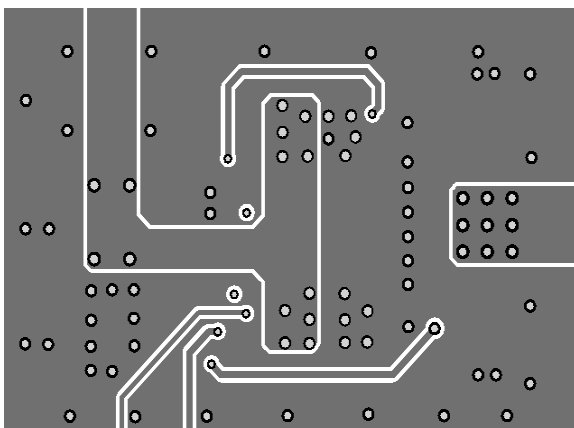
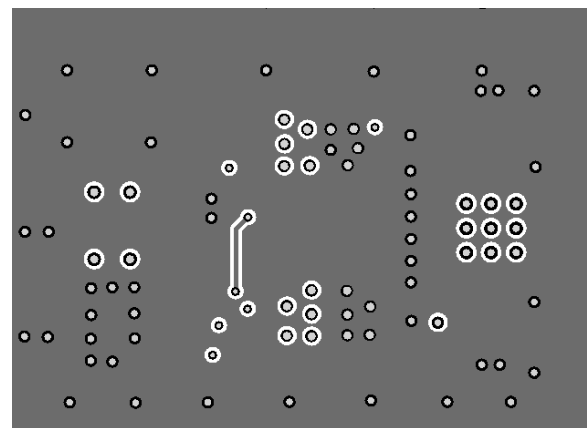

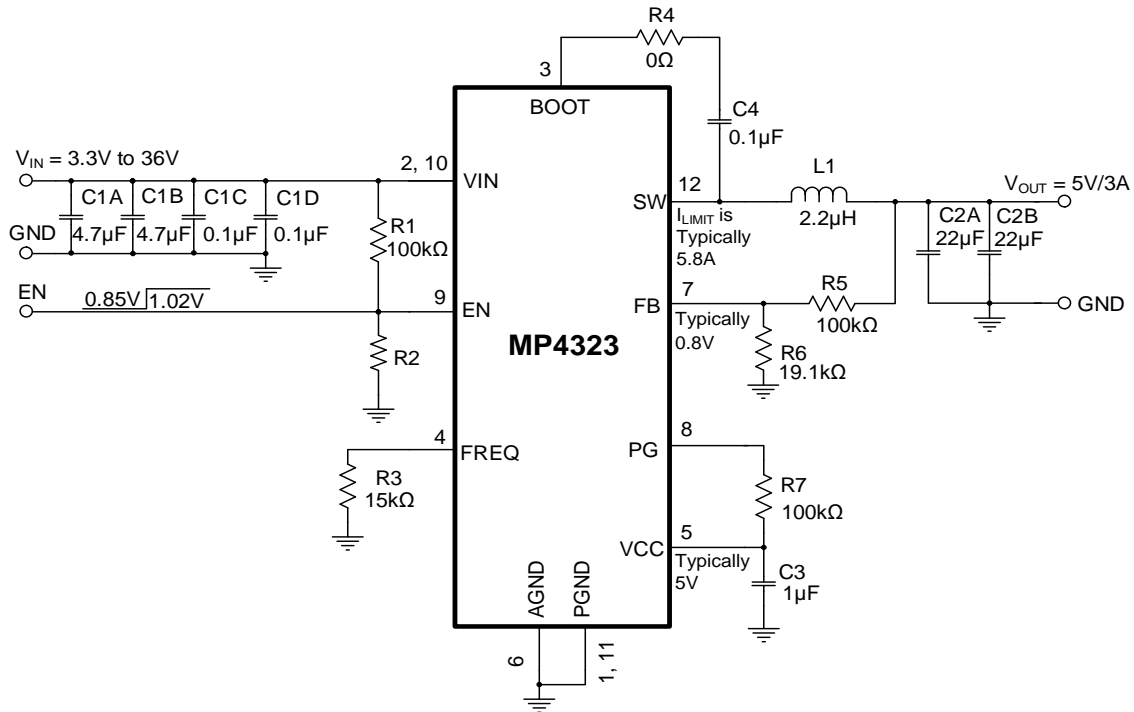
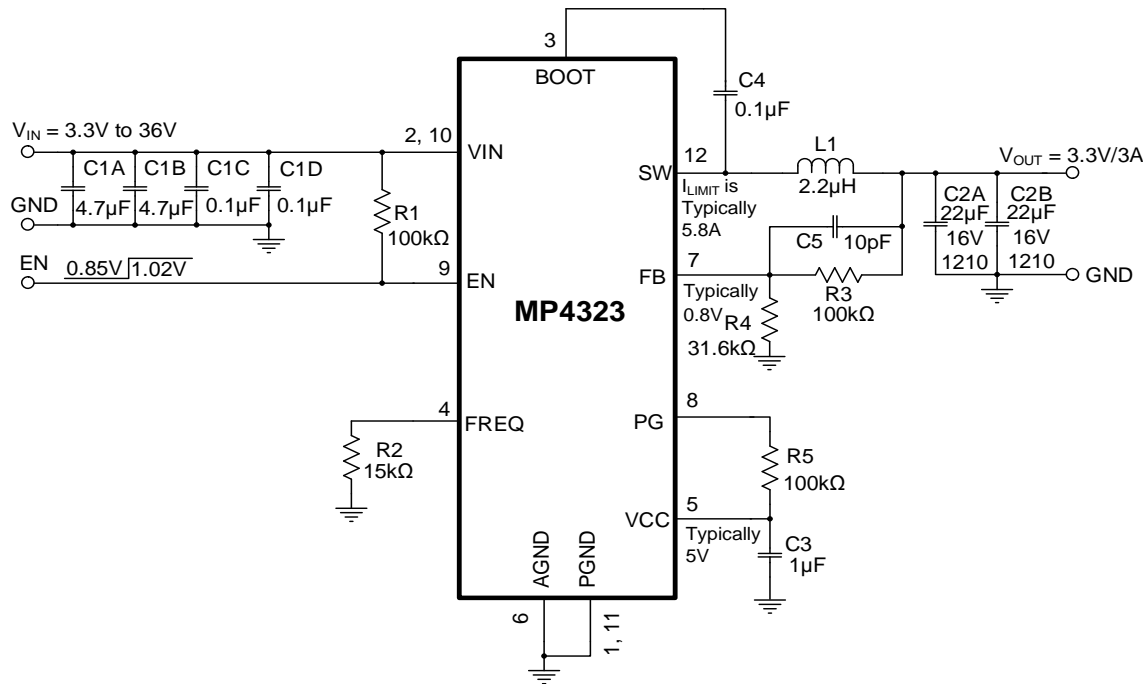
Top Layer and Top Silk

Mid-Layer 1

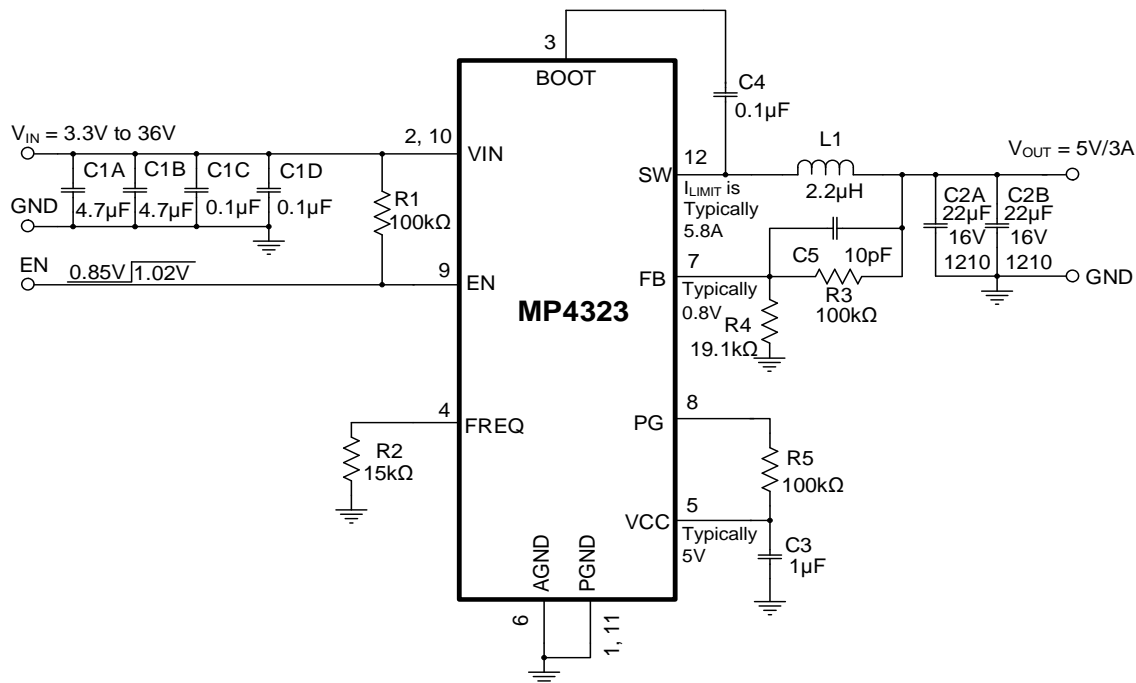
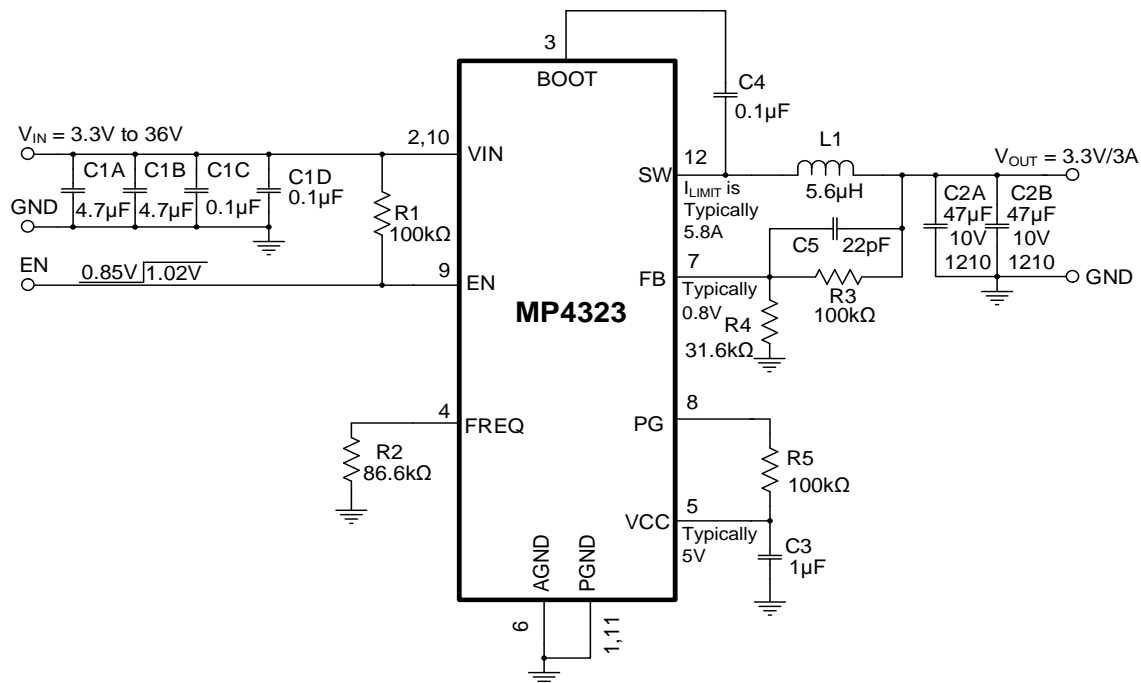
Mid-Layer 2

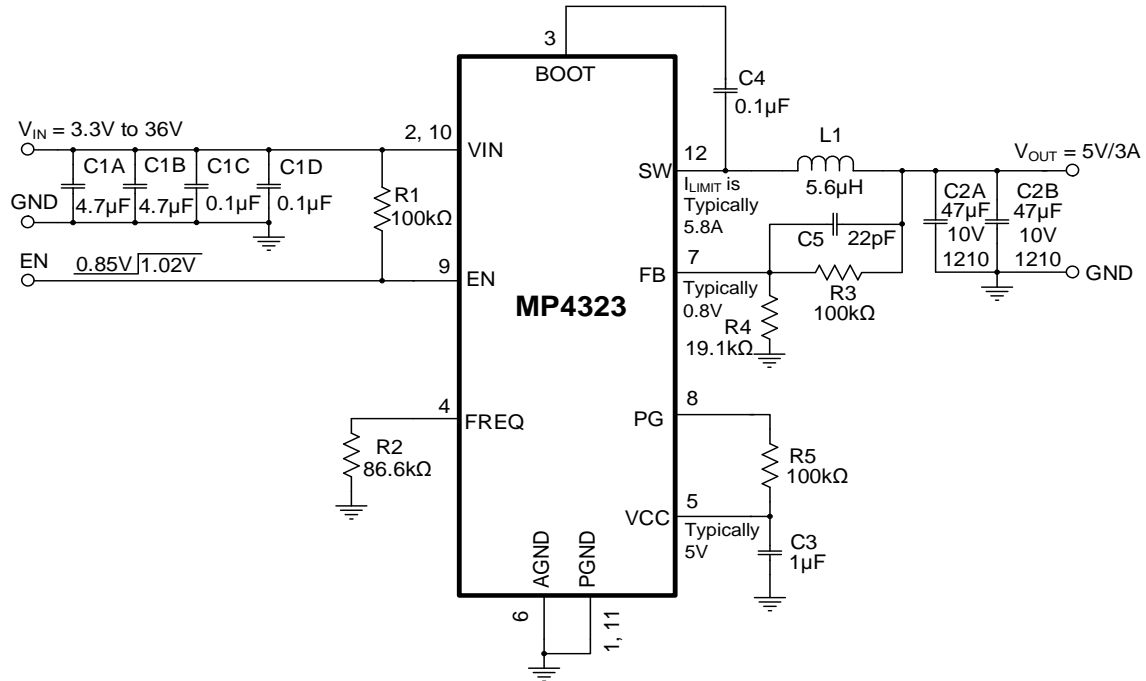
Bottom Layer and Bottom Silk
Figure 10: Recommended PCB Layout

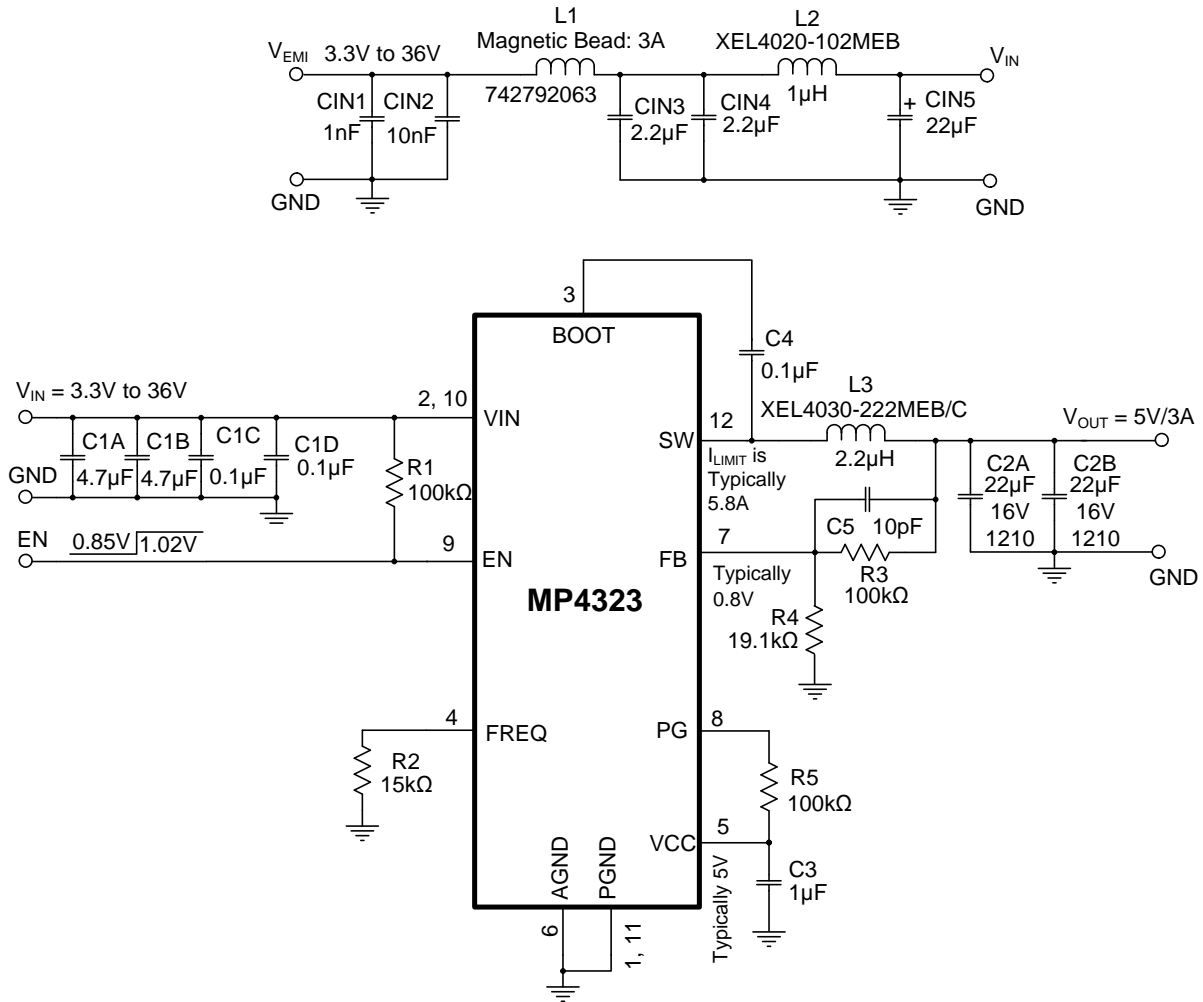
TYPICAL APPLICATION CIRCUITS

Figure 11: Typical Application Circuit with Bootstrap Resistor (R4) ($V_{OUT} = 5V$, $f_{sw} = 2.2MHz$)

Figure 12: Typical Application Circuit ($V_{OUT} = 3.3V$, $f_{sw} = 2.2MHz$)

TYPICAL APPLICATION CIRCUITS (continued)

 Figure 13: Typical Application Circuit ($V_{OUT} = 5V$, $f_{sw} = 2.2MHz$)

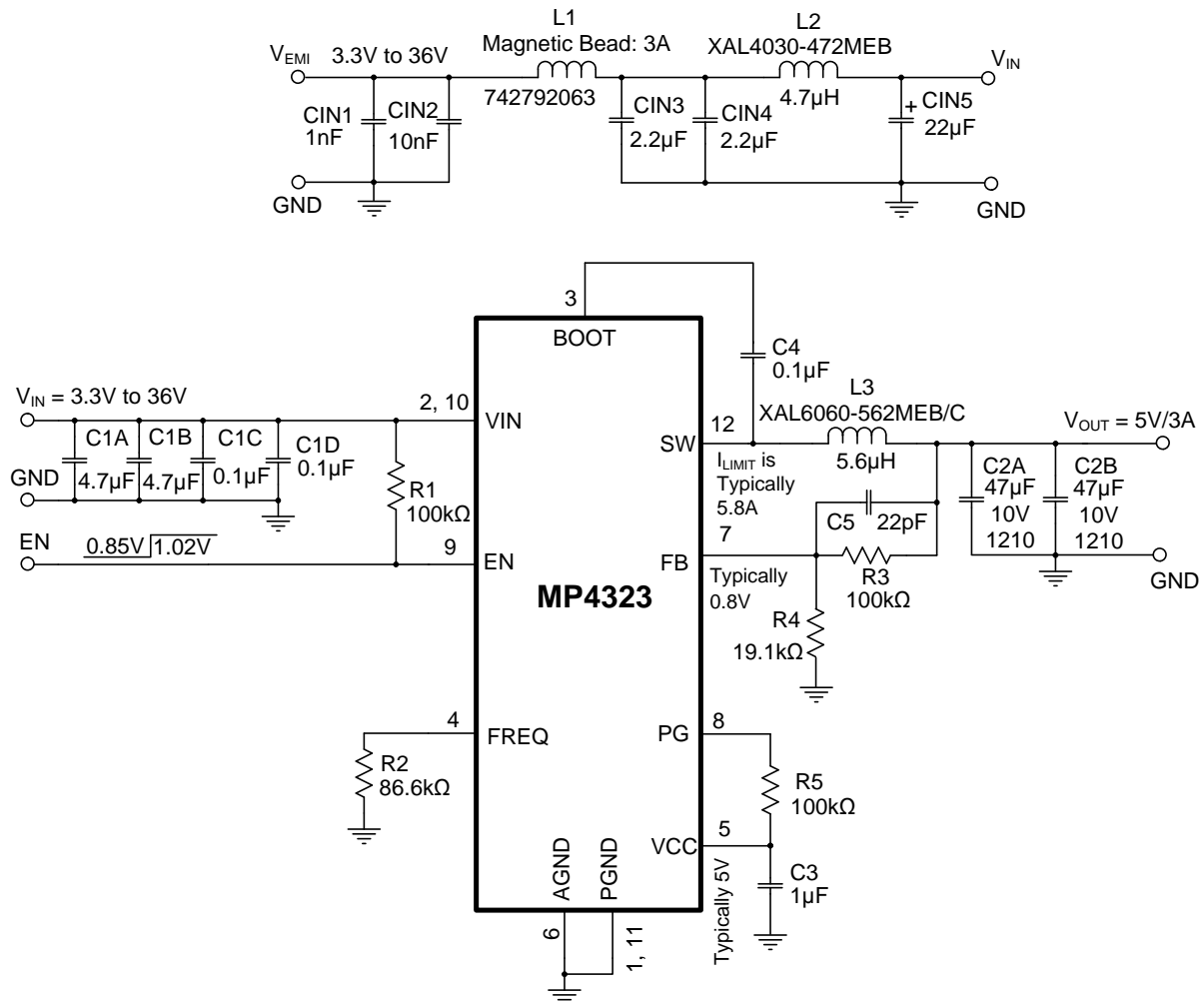
 Figure 14: Typical Application Circuit ($V_{OUT} = 3.3V$, $f_{sw} = 415kHz$)

TYPICAL APPLICATION CIRCUITS (continued)

Figure 15: Typical Application Circuit ($V_{OUT} = 5V$, $f_{SW} = 415kHz$)

TYPICAL APPLICATION CIRCUITS (continued)

Figure 16: Typical Application Circuit ($V_{OUT} = 5V$, $f_{SW} = 2.2MHz$ with EMI Filters)

TYPICAL APPLICATION CIRCUITS (continued)

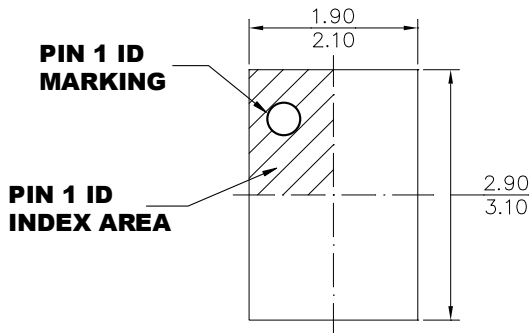
Figure 17: Typical Application Circuit ($V_{OUT} = 5V$, $f_{SW} = 415kHz$ with EMI Filters)

PACKAGE INFORMATION

**QFN-12 (2mmx3mm)
Wettable Flank**

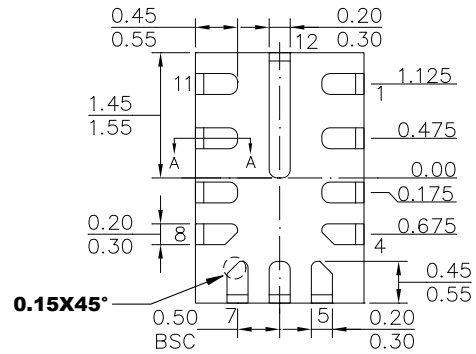

TOP VIEW



BOTTOM VIEW

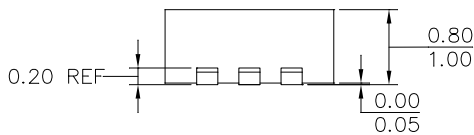

SIDE VIEW

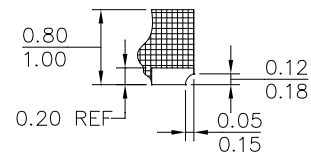

SECTION A-A

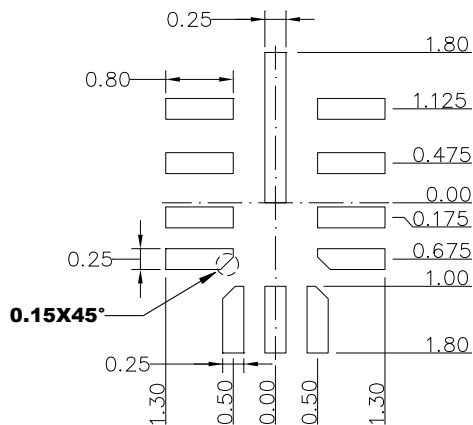

RECOMMENDED LAND PATTERN

- NOTE:**
- 1) THE LEAD SIDE IS WETTABLE.
 - 2) ALL DIMENSIONS ARE IN MILLIMETERS.
 - 3) LEAD COPLANARITIES SHALL BE 0.08 MILLIMETERS MAX.
 - 4) JEDEC REFERENCE IS MO-220.
 - 5) DRAWING IS NOT TO SCALE.

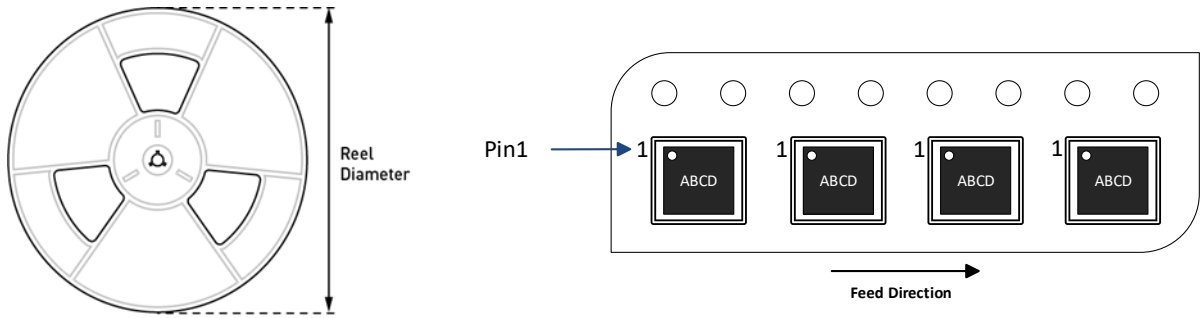
CARRIER INFORMATION

Part Number	Package Description	Quantity/ Reel	Quantity/ Tube ⁽¹⁵⁾ ⁽¹⁷⁾	Quantity/ Tray ⁽¹⁶⁾	Reel Diameter	Carrier Tape Width	Carrier Tape Pitch
MP4323GDE-Z	QFN-12 (2mmx3mm)	5000	N/A	N/A	13in	12mm	8mm

Notes:

15) N/A indicates that this part is “not available” in tubes.

16) N/A indicates that this part is “not available” in trays.

17) Contact an MPS FAE for 500-piece tape and reel prototype quantities. The order code for a 500-piece small reel is “-P”. The tape and reel dimensions of the small reel are the same as a full reel.

REVISION HISTORY

Revision #	Revision Date	Description	Pages Updated
1.0	11/11/2021	Initial Release	-

Notice: The information in this document is subject to change without notice. Please contact MPS for current specifications. Users should warrant and guarantee that third-party Intellectual Property rights are not infringed upon when integrating MPS products into any application. MPS will not assume any legal responsibility for any said applications.