



CERAMIC

# High Pass Filter

## HFCN-1300+

50Ω 1400 to 5000 MHz

### THE BIG DEAL

- Small size
- 7 sections
- Temperature stable
- Excellent power handling, 7W
- Hermetically sealed
- LTCC construction
- Low cost

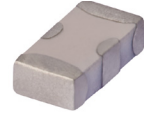

Generic photo used for illustration purposes only

CASE STYLE: FV1206

### +RoHS Compliant

The +Suffix identifies RoHS Compliance. See our web site for RoHS Compliance methodologies and qualifications

### APPLICATIONS

- Sub-harmonic rejection
- Transmitters/receivers
- Lab use

### ELECTRICAL SPECIFICATIONS<sup>1,2</sup> AT 25°C

Parameter	Frequency (MHz)	Min.	Typ.	Max.	Units	
Stop Band	Rejection Loss	690	40	—	—	dB
		930	20	—	—	
	Freq. Cut-Off	1300	—	3.0	—	
	VSWR	690-930	—	20	—	
Pass Band	Insertion Loss	1400-5000	—	2.0	—	dB
		1510-4000	—	—	1.3	dB
	VSWR	1400-4000	—	1.5	—	:1

1. In Application where DC voltage is present at either input or output ports, coupling capacitors are required. Alternatively, Mini-Circuits' "D" suffix version of this model will provide >100 MOhm isolation to ground.

2. Measured on Mini-Circuits Characterization Test Board TB-270.

### MAXIMUM RATINGS

Parameter	Ratings
Operating temperature	-55°C to 100°C
Storage temperature	-55°C to 100°C
RF Power Input <sup>3</sup>	7 W max. at 25°C

3. Passband rating, derate linearly to 3W at 100°C ambient. Permanent damage may occur if any of these limits are exceeded.

### TYPICAL FREQUENCY RESPONSE

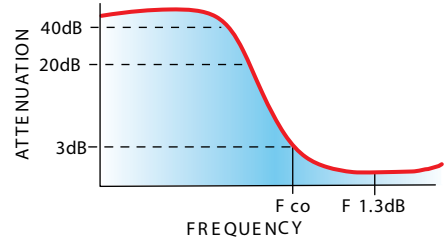

### FUNCTIONAL SCHEMATIC

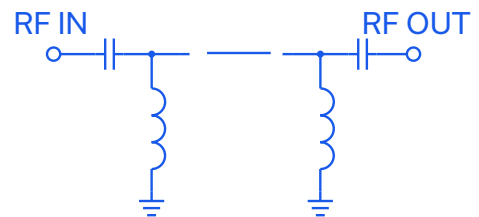

REV. L  
ECO-011980  
HFCN-1300+  
AD/CP/AM  
220221



### PIN CONNECTIONS

RF IN	1
RF OUT	3
GROUND	2,4

PRODUCT MARKING: N/A

DEMO BOARD MCL P/N: TB-270  
SUGGESTED PCB LAYOUT (PL-137)

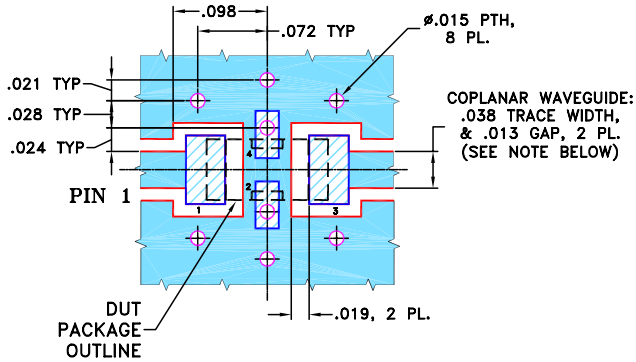

- NOTES:**
1. COPLANAR WAVEGUIDE PARAMETERS ARE SHOWN FOR ROGERS RO4350B WITH THICKNESS .020" ± .0015". COPPER: 1/2 OZ. EACH SIDE. FOR OTHER MATERIALS TRACE WIDTH & GAP MAY NEED TO BE MODIFIED.
  2. BOTTOM SIDE OF THE PCB IS CONTINUOUS GROUND PLANE.

- DENOTES PCB COPPER LAYOUT WITH SMOBC (SOLDER MASK OVER BARE COPPER)
- DENOTES COPPER LAND PATTERN FREE OF SOLDER MASK

### OUTLINE DRAWING

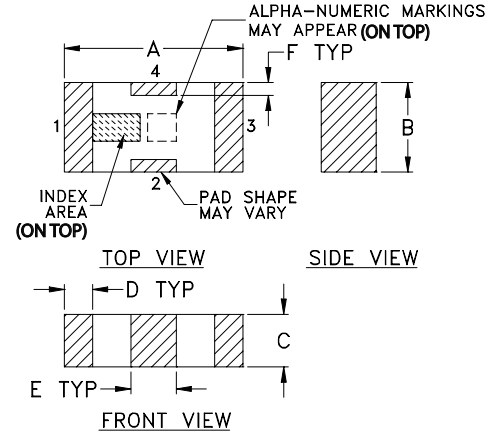

### PCB Land Pattern

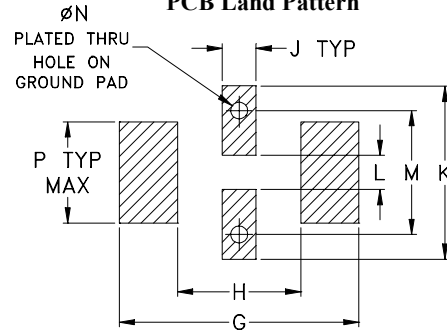

Suggested Layout,  
Tolerance to be within ±.002

### OUTLINE DIMENSIONS (Inches mm)

A	B	C	D	E	F	G
.126	.063	.037	.020	.032	.009	.169
3.20	1.60	0.94	0.51	0.81	0.23	4.29

H	J	K	L	M	N	P	wt
.087	.024	.122	.024	.087	.012	.071	grams
2.21	0.61	3.10	0.61	2.21	0.30	1.80	.020

### TAPE & REEL INFORMATION: F71



CERAMIC

# High Pass Filter

## HFCN-1300+

Mini-Circuits

### TYPICAL PERFORMANCE DATA AT 25°C

Frequency (MHz)	Insertion Loss (dB)	VSWR (:1)
1.00	89.20	868.59
100.00	68.18	868.59
690.00	49.67	72.39
930.00	28.30	39.49
1150.00	12.20	14.74
1230.00	6.92	7.11
1300.00	3.49	3.39
1400.00	1.44	1.61
1510.00	1.01	1.36
3000.00	0.51	1.34
4000.00	0.53	1.25
5000.00	1.39	2.32
7000.00	4.70	6.24

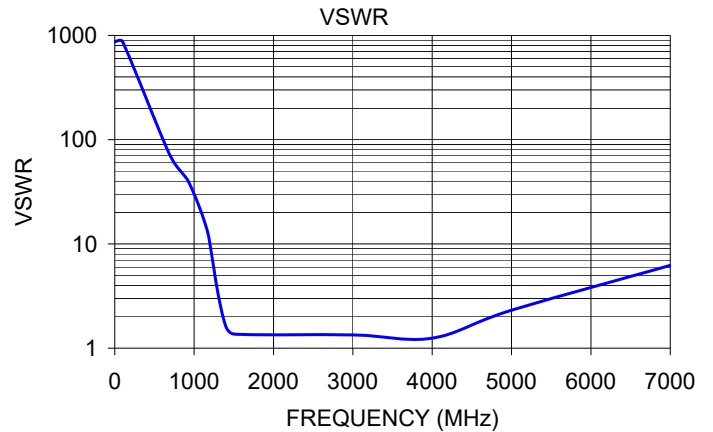
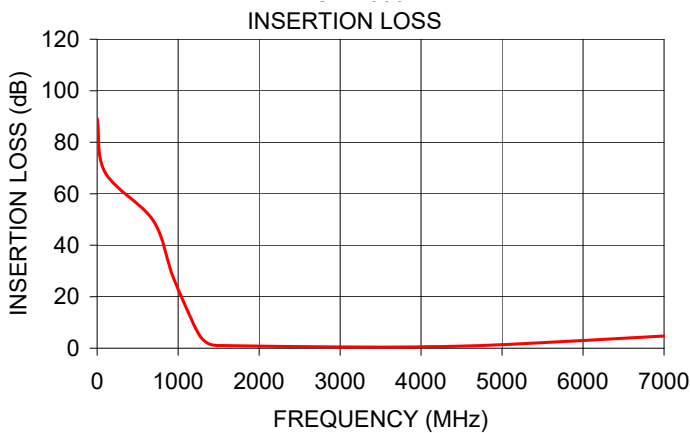

#### NOTES

- A. Performance and quality attributes and conditions not expressly stated in this specification document are intended to be excluded and do not form a part of this specification document.
- B. Electrical specifications and performance data contained in this specification document are based on Mini-Circuit's applicable established test performance criteria and measurement instructions.
- C. The parts covered by this specification document are subject to Mini-Circuits standard limited warranty and terms and conditions (collectively, "Standard Terms"); Purchasers of this part are entitled to the rights and benefits contained therein. For a full statement of the standard. Terms and the exclusive rights and remedies thereunder, please visit Mini-Circuits' website at [www.minicircuits.com/MCLStore/terms.jsp](http://www.minicircuits.com/MCLStore/terms.jsp)

