

Device Overview

The 89HPES16NT2 is a member of the IDT PRECISE™ family of PCI Express® switching solutions offering the next-generation I/O interconnect standard. The PES16NT2 is a 16-lane, 2-port peripheral chip that provides high-performance switching and non-transparent bridging (NTB) functions between a PCIe® upstream port and an NTB downstream port. The PES16NT2 is a part of the IDT PCIe System Interconnect Products and is intended to be used with IDT PCIe System Interconnect Switches. Together, the chipset targets multi-host and intelligent I/O applications such as communications, storage, and blade servers where inter-domain communication is required.

Features

- ◆ **High Performance PCI Express Switch**
 - Sixteen PCI Express lanes (2.5Gbps), two switch ports
 - Delivers 64 Gbps (8 GBps) of aggregate switching capacity
 - Low latency cut-through switch architecture
 - Support for Max Payload size up to 2048 bytes
 - Supports one virtual channel and eight traffic classes
 - PCI Express Base specification Revision 1.0a compliant
- ◆ **Flexible Architecture with Numerous Configuration Options**
 - Supports automatic per port link width negotiation (x8, x4, x2, or x1)
 - Static lane reversal on all ports
 - Automatic polarity inversion on all lanes

- Supports locked transactions, allowing use with legacy software
- Ability to load device configuration from serial EEPROM
- Ability to control device via SMBus
- ◆ **Non-Transparent Port**
 - Crosslink support on NTB port
 - Four mapping windows supported
 - Each may be configured as a 32-bit memory or I/O window
 - May be paired to form a 64-bit memory window
 - Interprocessor communication
 - Thirty-two inbound and outbound doorbells
 - Four inbound and outbound message registers
 - Two shared scratchpad registers
 - Allows up to sixteen masters to communicate through the non-transparent port
 - No limit on the number of supported outstanding transactions through the non-transparent bridge
 - Completely symmetric non-transparent bridge operation allows similar/same configuration software to be run
 - Supports direct connection to a transparent or non-transparent port of another switch
- ◆ **Highly Integrated Solution**
 - Requires no external components
 - Incorporates on-chip internal memory for packet buffering and queueing
 - Integrates sixteen 2.5 Gbps embedded full duplex SerDes, 8B/10B encoder/decoder (no separate transceivers needed)

Block Diagram

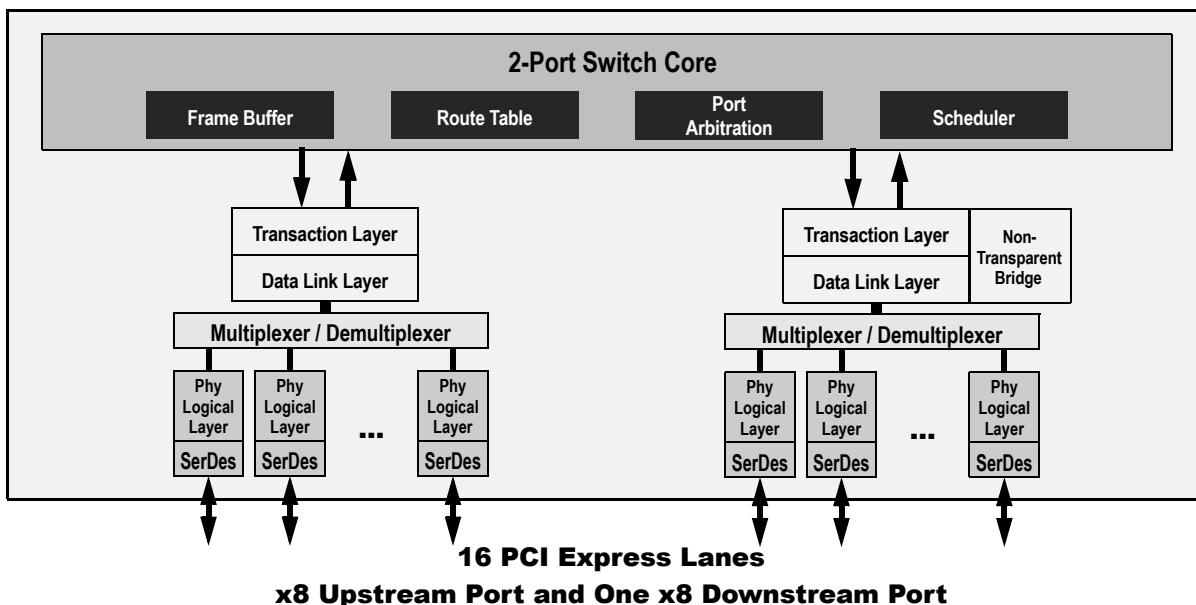

Figure 1 Internal Block Diagram

- ◆ **Reliability, Availability, and Serviceability (RAS) Features**
 - Internal end-to-end parity protection on all TLPs ensures data integrity even in systems that do not implement end-to-end CRC (ECRC)
 - Supports ECRC pass-through
 - Supports Hot-Swap
- ◆ **Power Management**
 - Supports PCI Power Management Interface specification, Revision 1.1 (PCI-PM)
 - Unused SerDes are disabled
- ◆ **Testability and Debug Features**
 - Built in SerDes Pseudo-Random Bit Stream (PRBS) generator
 - Ability to read and write any internal register via the SMBus
 - Ability to bypass link training and force any link into any mode
 - Provides statistics and performance counters
- ◆ **Two SMBus Interfaces**
 - Slave interface provides full access to all software-visible registers by an external SMBus master
 - Master interface provides connection for an optional serial EEPROM used for initialization
 - Master and slave interfaces may be tied together so the switch can act as both master and slave
- ◆ **Eight General Purpose Input/Output pins**
- ◆ **Packaged in a 23mm x 23mm 484-ball BCG with 1mm ball spacing**

Product Description

Utilizing standard PCI Express interconnect, the PES16NT2 provides the most efficient high-performance I/O connectivity solution for applications requiring high throughput, low latency, and simple board layout with a minimum number of board layers. With support for non-transparent bridging, the PES16NT2 is part of the IDT PCIe System Interconnect Products that target multi-host and intelligent I/O applications requiring inter-domain communication. The PES16NT2 provides 64 Gbps (8 GBps) of aggregated, full-duplex switching capacity through 16 integrated serial lanes, using proven and robust IDT technology. Each lane provides 2.5 Gbps of bandwidth in both directions and is fully compliant with PCI Express Base specification 1.0a.

The PES16NT2 is based on a flexible and efficient layered architecture. The PCI Express layer consists of SerDes, Physical, Data Link, and Transaction layers in compliance with PCI Express Base specification Revision 1.0a. The PES16NT2 can operate either as a store and forward or cut-through switch depending on the packet size and is designed to switch memory and I/O transactions. It supports eight Traffic Classes (TCs) and one Virtual Channel (VC) with sophisticated resource management.

Switch Configuration

The PES16NT2 is a two port switch that contains sixteen PCI Express lanes. Each of the two ports is statically allocated eight lanes with ports labeled as A and C. Port A is the upstream port and port C is the non-transparent downstream port.

During link training, link width is automatically negotiated. Each PES16NT2 port is capable of independently negotiating to a x8, x4, x2, or x1 width. Thus, the PES16NT2 may be used in virtually any two port switch configuration (e.g., {x8, x8}, {x4, x4}, {x4, x2}, etc.). The PES16NT2 supports static lane reversal. For example, lane reversal for upstream port A may be configured by asserting the PCI Express Port A Lane Reverse (PEALREV) input signal or through serial EEPROM or SMBus initialization. Lane reversal for port C may be enabled via a configuration space register, serial EEPROM, or the SMBus.

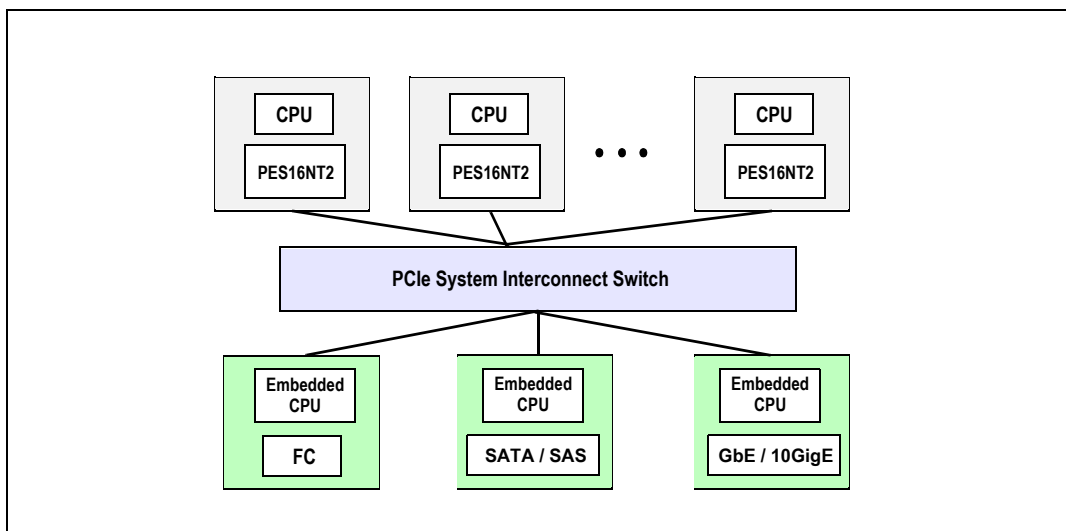

Figure 2 PCIe System Interconnect Architecture Block Diagram

Pin Description

The following tables list the functions of the pins provided on the PES16NT2. Some of the functions listed may be multiplexed onto the same pin. The active polarity of a signal is defined using a suffix. Signals ending with an “N” are defined as being active, or asserted, when at a logic zero (low) level. All other signals (including clocks, buses, and select lines) will be interpreted as being active, or asserted, when at a logic one (high) level.

Signal	Type	Name/Description
PEALREV	I	PCI Express Port A Lane Reverse. When this bit is asserted, the lanes of PCI Express Port A are reversed. This value may be overridden by modifying the value of the PALREV bit in the PA_SWCTL register.
PEARP[7:0] PEARN[7:0]	I	PCI Express Port A Serial Data Receive. Differential PCI Express receive pairs for port A.
PEATP[7:0] PEATN[7:0]	O	PCI Express Port A Serial Data Transmit. Differential PCI Express transmit pairs for port A
PECLREV	I	PCI Express Port C Lane Reverse. When this bit is asserted, the lanes of PCI Express Port C are reversed. This value may be overridden by modifying the value of the PCLREV bit in the PA_SWCTL register.
PECRP[7:0] PECRN[7:0]	I	PCI Express Port C Serial Data Receive. Differential PCI Express receive pairs for port C.
PECTP[7:0] PECTN[7:0]	O	PCI Express Port C Serial Data Transmit. Differential PCI Express transmit pairs for port C
PEREFCLKP[1:0] PEREFCLKN[1:0]	I	PCI Express Reference Clock. Differential reference clock pair input. This clock is used as the reference clock by on-chip PLLs to generate the clocks required for the system logic and on-chip SerDes. The frequency of the differential reference clock is determined by the REFCLKM signal.
REFCLKM	I	PCI Express Reference Clock Mode Select. These signals select the frequency of the reference clock input. 0x0 - 100 MHz 0x1 - 125 MHz

Table 1 PCI Express Interface Pins

Signal	Type	Name/Description
MSMBADDR[4:1]	I	Master SMBus Address. These pins determine the SMBus address of the serial EEPROM from which configuration information is loaded.
MSMBCLK	I/O	Master SMBus Clock. This bidirectional signal is used to synchronize transfers on the master SMBus. It is active and generating the clock only when the EEPROM is being accessed.
MSMBDAT	I/O	Master SMBus Data. This bidirectional signal is used for data on the master SMBus.
SSMBADDR[5,3:1]	I	Slave SMBus Address. These pins determine the SMBus address to which the slave SMBus interface responds.
SSMBCLK	I/O	Slave SMBus Clock. This bidirectional signal is used to synchronize transfers on the slave SMBus.
SSMBDAT	I/O	Slave SMBus Data. This bidirectional signal is used for data on the slave SMBus.

Table 2 SMBus Interface Pins

Signal	Type	Name/Description
GPIO[0]	I/O	General Purpose I/O. This pin can be configured as a general purpose I/O pin.
GPIO[1]	I/O	General Purpose I/O. This pin can be configured as a general purpose I/O pin. Alternate function pin name: PECRSTN Alternate function pin type: Output Alternate function: Reset output for downstream port C
GPIO[2]	I/O	General Purpose I/O. This pin can be configured as a general purpose I/O pin. Alternate function pin name: PALINKUPN Alternate function pin type: Output Alternate function: Port A link up status output
GPIO[3]	I/O	General Purpose I/O. This pin can be configured as a general purpose I/O pin.
GPIO[4]	I/O	General Purpose I/O. This pin can be configured as a general purpose I/O pin. Alternate function pin name: PCLINKUPN Alternate function pin type: Output Alternate function: Port C link up status output
GPIO[5]	I/O	General Purpose I/O. This pin can be configured as a general purpose I/O pin. Alternate function pin name: FAILOVERP Alternate function pin type: Input Alternate function: NTB upstream port failover
GPIO[6]	I/O	General Purpose I/O. This pin can be configured as a general purpose I/O pin.
GPIO[7]	I/O	General Purpose I/O. This pin can be configured as a general purpose I/O pin.

Table 3 General Purpose I/O Pins

Signal	Type	Name/Description
CCLKDS	I	Common Clock Downstream. When the CCLKDS pin is asserted, it indicates that a common clock is being used between the downstream device and the downstream port.
CCLKUS	I	Common Clock Upstream. When the CCLKUS pin is asserted, it indicates that a common clock is being used between the upstream device and the upstream port.
MSMBSMODE	I	Master SMBus Slow Mode. The assertion of this pin indicates that the master SMBus should operate at 100 KHz instead of 400 KHz. This value may not be overridden.
PENTBRSTN	I	Non-Transparent Bridge Reset. Assertion of this signal indicates a reset on the external side of the non-transparent bridge. This signal is only used when the switch mode selects a non-transparent mode and has no effect otherwise.
PERSTN	I	Fundamental Reset. Assertion of this signal resets all logic inside the PES16NT2 and initiates a PCI Express fundamental reset.
RSTHALT	I	Reset Halt. When this signal is asserted during a PCI Express fundamental reset, the PES16NT2 executes the reset procedure and remains in a reset state with the Master and Slave SMBuses active. This allows software to read and write registers internal to the device before normal device operation begins. The device exits the reset state when the RSTHALT bit is cleared in the PA_SWCTL register by an SMBus master.
SWMODE[3:0]	I	Switch Mode. These configuration pins determine the PES16NT2 switch operating mode. 0x0 - Transparent mode 0x1 - Transparent mode with serial EEPROM initialization 0x2 - Non-transparent mode 0x3 - Non-transparent mode with serial EEPROM initialization 0x4 - Non-transparent failover mode 0x5 - Non-transparent failover mode with serial EEPROM initialization 0x6 through 0xF - Reserved

Table 4 System Pins

Signal	Type	Name/Description
JTAG_TCK	I	JTAG Clock. This is an input test clock used to clock the shifting of data into or out of the boundary scan logic or JTAG Controller. JTAG_TCK is independent of the system clock with a nominal 50% duty cycle.
JTAG_TDI	I	JTAG Data Input. This is the serial data input to the boundary scan logic or JTAG Controller.

Table 5 Test Pins (Part 1 of 2)

Signal	Type	Name/Description
JTAG_TDO	O	JTAG Data Output. This is the serial data shifted out from the boundary scan logic or JTAG Controller. When no data is being shifted out, this signal is tri-stated.
JTAG_TMS	I	JTAG Mode. The value on this signal controls the test mode select of the boundary scan logic or JTAG Controller.
JTAG_TRST_N	I	JTAG Reset. This active low signal asynchronously resets the boundary scan logic and JTAG TAP Controller. An external pull-up on the board is recommended to meet the JTAG specification in cases where the tester can access this signal. However, for systems running in functional mode, one of the following should occur: <ul style="list-style-type: none"> 1) actively drive this signal low with control logic 2) statically drive this signal low with an external pull-down on the board

Table 5 Test Pins (Part 2 of 2)

Signal	Type	Name/Description
V _{DD} CORE	I	Core V_{DD}. Power supply for core logic.
V _{DD} IO	I	I/O V_{DD}. LVTTTL I/O buffer power supply.
V _{DD} PE	I	PCI Express Digital Power. PCI Express digital power used by the digital power of the SerDes.
V _{DD} APE	I	PCI Express Analog Power. PCI Express analog power used by the PLL and bias generator.
V _{TT} PE	I	PCI Express Termination Power.
V _{SS}	I	Ground.

Table 6 Power and Ground Pins

Pin Characteristics

Note: Some input pads of the PES16NT2 do not contain internal pull-ups or pull-downs. Unused inputs should be tied off to appropriate levels. This is especially critical for unused control signal inputs which, if left floating, could adversely affect operation. Also, any input pin left floating can cause a slight increase in power consumption.

Function	Pin Name	Type	Buffer	I/O Type	Internal Resistor	Notes
PCI Express Interface	PEALREV	I	LVTTTL	Input	pull-down	
	PEARNT[7:0]	I	CML	Serial link		
	PEARP[7:0]	I				
	PEATN[7:0]	O				
	PEATP[7:0]	O				
	PECLREV	I			LVTTTL	Input
	PECRN[7:0]	I	CML	Serial link		
	PECRP[7:0]	I				
	PECTN[7:0]	O				
	PECTP[7:0]	O				
	PEREFCLKN[1:0]	I	LVPECL/ CML	Diff. Clock Input		Refer to Table 8
	PEREFCLKP[1:0]	I				
REFCLKM	I	LVTTTL	Input	pull-down		
SMBus	MSMBADDR[4:1]	I	LVTTTL	Input	pull-up	
	MSMBCLK	I/O		STI		
	MSMBDAT	I/O				
	SSMBADDR[5,3:1]	I		Input	pull-up	
	SSMBCLK	I/O		STI		
	SSMBDAT	I/O				
General Purpose I/O	GPIO[7:0]	I/O	LVTTTL	Input, High Drive	pull-up	
System Pins	CCLKDS	I	LVTTTL	Input	pull-up	
	CCLKUS	I			pull-up	
	MSMBSMODE	I			pull-down	
	PENTBRSTN	I				
	PERSTN	I				
	RSTHALT	I			pull-down	
	SWMODE[3:0]	I			pull-up	
JTAG	JTAG_TCK	I	LVTTTL	STI	pull-up	
	JTAG_TDI	I			pull-up	
	JTAG_TDO	O		Low Drive		
	JTAG_TMS	I		STI	pull-up	
	JTAG_TRST_N	I			pull-up	External pull-down

Table 7 Pin Characteristics

Logic Diagram — PES16NT2

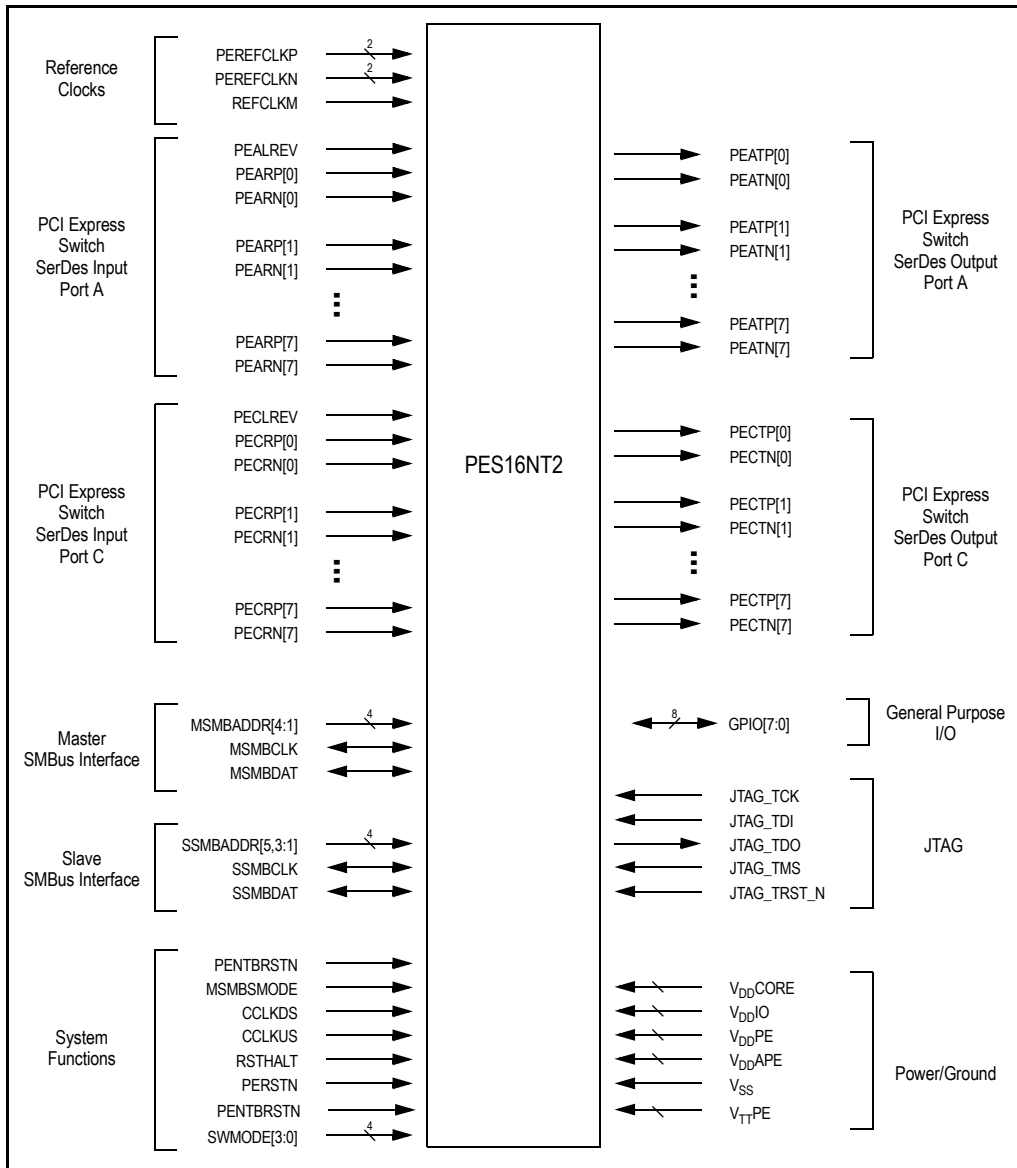

Figure 3 PES16NT2 Logic Diagram

System Clock Parameters

Values based on systems running at recommended supply voltages and operating temperatures, as shown in Tables 12 and 13.

Parameter	Description	Min	Typical	Max	Unit
Refclk _{FREQ}	Input reference clock frequency range	100		125 ¹	MHz
Refclk _{DC} ²	Duty cycle of input clock	40	50	60	%
T _R , T _F	Rise/Fall time of input clocks			0.2*RCUI	RCUI ³
V _{SW}	Differential input voltage swing ⁴	0.6		1.6	V
T _{jitter}	Input clock jitter (cycle-to-cycle)			125	ps
R _T	Termination Resistor		110		Ohms

Table 8 Input Clock Requirements

¹ The input clock frequency will be either 100 or 125 MHz depending on signal REFCLKM.

² ClkIn must be AC coupled. Use 0.01 — 0.1 μF ceramic capacitors.

³ RCUI (Reference Clock Unit Interval) refers to the reference clock period.

⁴ AC coupling required.

AC Timing Characteristics

Parameter	Description	Min ¹	Typical ¹	Max ¹	Units
PCIe Transmit					
UI	Unit Interval	399.88	400	400.12	ps
T _{TX-EYE}	Minimum Tx Eye Width	0.7	.9		UI
T _{TX-EYE-MEDIAN-to-MAX-JITTER}	Maximum time between the jitter median and maximum deviation from the median			0.15	UI
T _{TX-RISE} , T _{TX-FALL}	D+ / D- Tx output rise/fall time	50	90		ps
T _{TX-IDLE-MIN}	Minimum time in idle	50			UI
T _{TX-IDLE-SET-TO-IDLE}	Maximum time to transition to a valid Idle after sending an Idle ordered set			20	UI
T _{TX-IDLE-TO-DIFF-DATA}	Maximum time to transition from valid idle to diff data			20	UI
T _{TX-SKEW}	Transmitter data skew between any 2 lanes		500	1300	ps
PCIe Receive					
UI	Unit Interval	399.88	400	400.12	ps
T _{RX-EYE (with jitter)}	Minimum Receiver Eye Width (jitter tolerance)	0.4			UI

Table 9 PCIe AC Timing Characteristics (Part 1 of 2)

Parameter	Description	Min ¹	Typical ¹	Max ¹	Units
T _{RX-EYE-MEDIUM TO MAX JITTER}	Max time between jitter median & max deviation			0.3	UI
T _{RX-IDLE-DET-DIFF-ENTER TIME}	Unexpected Idle Enter Detect Threshold Integration Time			10	ms
T _{RX-SKEW}	Lane to lane input skew			20	ns

Table 9 PCIe AC Timing Characteristics (Part 2 of 2)

¹: Minimum, Typical, and Maximum values meet the requirements under PCI Specification 1.1

Signal	Symbol	Reference Edge	Min	Max	Unit	Timing Diagram Reference
GPIO						
GPIO[7:0] ¹	T _{pw_13b} ²	None	50	—	ns	

Table 10 GPIO AC Timing Characteristics

¹: GPIO signals must meet the setup and hold times if they are synchronous or the minimum pulse width if they are asynchronous.

²: The values for this symbol were determined by calculation, not by testing.

Signal	Symbol	Reference Edge	Min	Max	Unit	Timing Diagram Reference
JTAG						
JTAG_TCK	T _{per_16a}	none	50.0	—	ns	See Figure 4.
	T _{high_16a, Tlow_16a}		10.0	25.0	ns	
JTAG_TMS ¹ , JTAG_TDI	T _{su_16b}	JTAG_TCK rising	2.4	—	ns	
	T _{hld_16b}		1.0	—	ns	
JTAG_TDO	T _{do_16c}	JTAG_TCK falling	—	20	ns	
	T _{dz_16c} ²		—	20	ns	
JTAG_TRST_N	T _{pw_16d} ²	none	25.0	—	ns	

Table 11 JTAG AC Timing Characteristics

¹: The JTAG specification, IEEE 1149.1, recommends that JTAG_TMS should be held at 1 while the signal applied at JTAG_TRST_N changes from 0 to 1. Otherwise, a race may occur if JTAG_TRST_N is deasserted (going from low to high) on a rising edge of JTAG_TCK when JTAG_TMS is low, because the TAP controller might go to either the Run-Test/Idle state or stay in the Test-Logic-Reset state.

²: The values for this symbol were determined by calculation, not by testing.

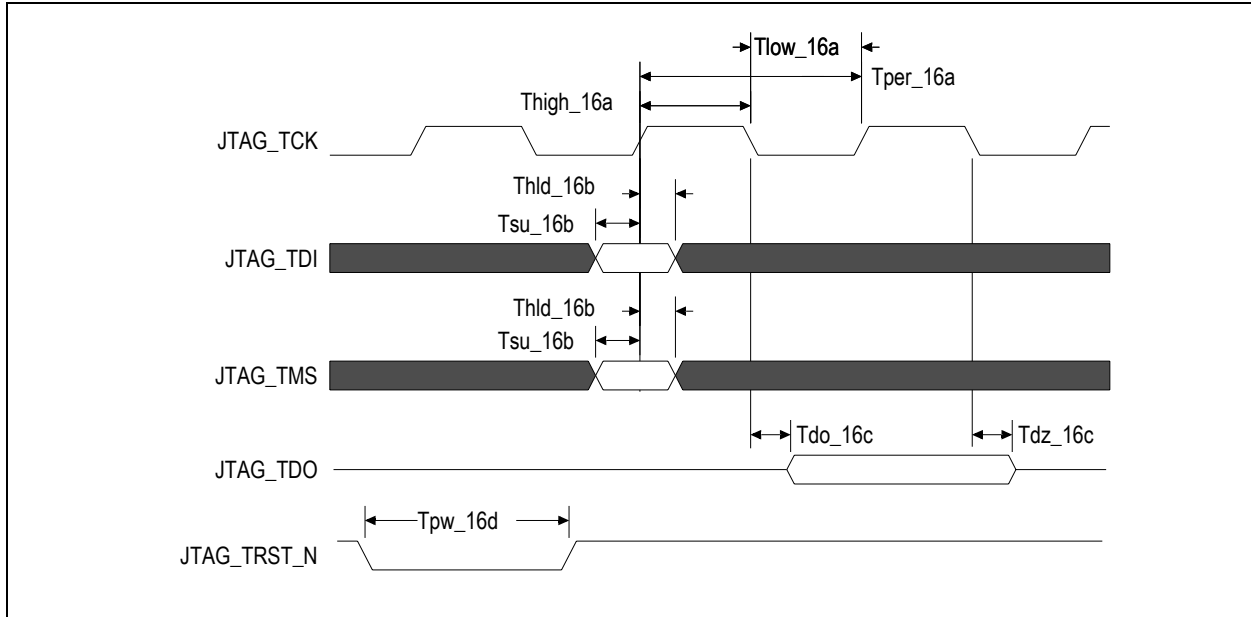

Figure 4 JTAG AC Timing Waveform

Recommended Operating Supply Voltages

Symbol	Parameter	Minimum	Typical	Maximum	Unit
V _{DD} CORE	Internal logic supply	0.9	1.0	1.1	V
V _{DD} I/O	I/O supply except for SerDes LVPECL/CML	3.0	3.3	3.6	V
V _{DD} PE	PCI Express Digital Power	0.9	1.0	1.1	V
V _{DD} APE	PCI Express Analog Power	0.9	1.0	1.1	V
V _{TT} PE	PCI Express Serial Data Transmit Termination Voltage	1.425	1.5	1.575	V
V _{SS}	Common ground	0	0	0	V

Table 12 PES16NT2 Operating Voltages

Power-Up Sequence

This section describes the sequence in which various voltages must be applied to the part during power-up to ensure proper functionality. For the PES16NT2, the power-up sequence must be as follows:

1. V_{DD}I/O — 3.3V
2. V_{DD}Core, V_{DD}PE, V_{DD}APE — 1.0V
3. V_{TT}PE — 1.5V

When powering up, each voltage level must ramp and stabilize prior to applying the next voltage in the sequence to ensure internal latch-up issues are avoided. There are no maximum time limitations in ramping to valid power levels. The power-down sequence must be in the reverse order of the power-up sequence.

Recommended Operating Temperature

Grade	Temperature
Commercial	0°C to +70°C Ambient

Table 13 PES16NT2 Operating Temperatures

Power Consumption

Typical power is measured under the following conditions: 25°C Ambient, 35% total link usage on all ports, typical voltages defined in Table 14.

Maximum power is measured under the following conditions: 70°C Ambient, 85% total link usage on all ports, maximum voltages defined in Table 14.

All power measurements assume that the part is mounted on a 10 layer printed circuit board with 0 LFM airflow.

Number of Connected Lanes: Port-A/Port-C	Core (Watts) (1.0V supply)		PCIe Digital (Watts) (1.0V supply)		PCIe Analog (Watts) (1.0V supply)		PCIe Termin- ation (Watts) (1.5V supply)		I/O (Watts) (3.3V supply)		Total (Watts)	
	Typ	Max	Typ	Max	Typ	Max	Typ	Max	Typ	Max	Typ	Max
8/8	472	546	697	905	266	345	354	440	1	3		
	0.47	0.60	0.70	1.00	0.27	0.38	0.53	0.69	0.003	0.01	1.97	2.68

Table 14 PES16NT2 Power Consumption

Thermal Considerations

This section describes thermal considerations for the PES16NT2 (23mm² BCG484 package). The data in Table 15 below contains information that is relevant to the thermal performance of the PES16NT2 switch.

Symbol	Parameter	Value	Units	Conditions
$T_{J(max)}$	Junction Temperature	125	°C	Maximum
$T_{A(max)}$	Ambient Temperature	70	°C	Maximum for commercial-rated products
$\theta_{JA(effective)}$	Effective Thermal Resistance, Junction-to-Ambient	11.5	°C/W	Zero air flow
		9.6	°C/W	1 m/S air flow
		9.0	°C/W	2 m/S air flow
θ_{JB}	Thermal Resistance, Junction-to-Board	10.9	°C/W	
θ_{JC}	Thermal Resistance, Junction-to-Case	5	°C/W	
P	Power Dissipation of the Device	2.68	Watts	Maximum

Table 15 Thermal Specifications for PES16NT2, 23x23mm BCG484 Package

Note: The parameter $\theta_{JA(eff)}$ is not the *absolute* thermal resistance for the package as defined by JEDEC (JESD-51). Because resistance can vary with the number of board layers, size of the board, and airflow, $\theta_{JA(eff)}$ is the *effective* thermal resistance. The values for effective θ_{JA} given above are based on a 10-layer, standard height, full length (4.3"x12.2") PCIe add-in card.

DC Electrical Characteristics

Values based on systems running at recommended supply voltages, as shown in Table 12.

Note: See Table 7, Pin Characteristics, for a complete I/O listing.

I/O Type	Parameter	Description	Min ¹	Typ ¹	Max ¹	Unit	Conditions
Serial Link	PCIe Transmit						
	$V_{TX-DIFFp-p}$	Differential peak-to-peak output voltage	800		1200	mV	
	$V_{TX-DE-RATIO}$	De-emphasized differential output voltage	-3		-4	dB	
	$V_{TX-DC-CM}$	DC Common mode voltage	-0.1	1	3.7	V	
	$V_{TX-CM-ACP}$	RMS AC peak common mode output voltage			20	mV	
	$V_{TX-CM-DC-active-idle-delta}$	Abs delta of DC common mode voltage between L0 and idle			100	mV	
	$V_{TX-CM-DC-line-delta}$	Abs delta of DC common mode voltage between D+ and D-			25	mV	
	$V_{TX-Idle-DiffP}$	Electrical idle diff peak output			20	mV	
Serial Link (cont.)	$V_{TX-RCV-Detect}$	Voltage change during receiver detection			600	mV	
	$RL_{TX-DIFF}$	Transmitter Differential Return loss	12			dB	
	RL_{TX-CM}	Transmitter Common Mode Return loss	6			dB	
	$Z_{TX-DEFF-DC}$	DC Differential TX impedance	80	100	120	Ω	
	Z_{OSE}	Single ended TX Impedance	40	50	60	Ω	
	Transmitter Eye Diagram	TX Eye Height (De-emphasized bits)	505	650		mV	
	Transmitter Eye Diagram	TX Eye Height (Transition bits)	800	950		mV	
	PCIe Receive						
	$V_{RX-DIFFp-p}$	Differential input voltage (peak-to-peak)	175		1200	mV	
	$V_{RX-CM-AC}$	Receiver common-mode voltage for AC coupling			150	mV	
	$RL_{RX-DIFF}$	Receiver Differential Return Loss	15			dB	
	RL_{RX-CM}	Receiver Common Mode Return Loss	6			dB	
	$Z_{RX-DIFF-DC}$	Differential input impedance (DC)	80	100	120	Ω	
	$Z_{RX-COMM-DC}$	Single-ended input impedance	40	50	60	Ω	
$Z_{RX-COMM-HIGH-Z-DC}$	Powered down input common mode impedance (DC)	200k	350k		Ω		
$V_{RX-IDLE-DET-DIFFp-p}$	Electrical idle detect threshold	65		175	mV		
PCIe REFCLK							
	C_{IN}	Input Capacitance	1.5	—		pF	

Table 16 DC Electrical Characteristics (Part 1 of 2)

I/O Type	Parameter	Description	Min ¹	Typ ¹	Max ¹	Unit	Conditions
Other I/Os							
LOW Drive Output	I _{OL}		—	2.5	—	mA	V _{OL} = 0.4v
	I _{OH}		—	-5.5	—	mA	V _{OH} = 1.5V
High Drive Output	I _{OL}		—	12.0	—	mA	V _{OL} = 0.4v
	I _{OH}		—	-20.0	—	mA	V _{OH} = 1.5V
Schmitt Trigger Input (STI)	V _{IL}		-0.3	—	0.8	V	—
	V _{IH}		2.0	—	V _{DD} I/O + 0.5	V	—
Input	V _{IL}		-0.3	—	0.8	V	—
	V _{IH}		2.0	—	V _{DD} I/O + 0.5	V	—
Capacitance	C _{IN}		—	—	8.5	pF	—
Leakage	Inputs		—	—	± 10	μA	V _{DD} I/O (max)
	I/O _{LEAK} w/o Pull-ups/downs		—	—	± 10	μA	V _{DD} I/O (max)
	I/O _{LEAK} WITH Pull-ups/downs		—	—	± 80	μA	V _{DD} I/O (max)

Table 16 DC Electrical Characteristics (Part 2 of 2)

¹: Minimum, Typical, and Maximum values meet the requirements under PCI Specification 1.0a.

Package Pinout — 484-BGA Signal Pinout for PES16NT2

The following table lists the pin numbers and signal names for the PES16NT2 device.

Pin	Function	Alt	Pin	Function	Alt	Pin	Function	Alt	Pin	Function	Alt
A1	V _{SS}		B13	PEATN03		D3	V _{SS}		E15	V _{TT} PE	
A2	V _{SS}		B14	V _{SS}		D4	PEARN07		E16	V _{DD} PE	
A3	V _{DD} CORE		B15	PEATP02		D5	V _{SS}		E17	V _{SS}	
A4	V _{SS}		B16	V _{SS}		D6	PEARP06		E18	V _{SS}	
A5	PEATN07		B17	PEATN01		D7	V _{TT} PE		E19	PECRN07	
A6	V _{SS}		B18	V _{SS}		D8	PEARN05		E20	PECRP07	
A7	PEATN06		B19	PEATP00		D9	V _{TT} PE		E21	V _{SS}	
A8	V _{SS}		B20	V _{SS}		D10	PEARP04		E22	V _{SS}	
A9	PEATN05		B21	V _{SS}		D11	V _{DD} PE		F1	V _{SS}	
A10	V _{SS}		B22	V _{SS}		D12	PEARP03		F2	V _{SS}	
A11	PEATN04		C1	V _{DD} CORE		D13	V _{SS}		F3	V _{DD} CORE	
A12	V _{SS}		C2	V _{DD} CORE		D14	PEARN02		F4	V _{SS}	
A13	PEATP03		C3	V _{DD} CORE		D15	V _{SS}		F5	V _{SS}	
A14	V _{SS}		C4	PEARP07		D16	PEARP01		F6	V _{DD} IO	
A15	PEATN02		C5	V _{SS}		D17	V _{SS}		F7	V _{SS}	
A16	V _{SS}		C6	PEARN06		D18	PEARN00		F8	V _{DD} PE	
A17	PEATP01		C7	V _{SS}		D19	V _{SS}		F9	V _{DD} APE	
A18	V _{SS}		C8	PEARP05		D20	V _{SS}		F10	V _{DD} APE	
A19	PEATN00		C9	V _{SS}		D21	PECTP07		F11	V _{DD} PE	
A20	V _{SS}		C10	PEARN04		D22	PECTN07		F12	V _{DD} PE	
A21	V _{SS}		C11	V _{SS}		E1	V _{DD} CORE		F13	V _{DD} APE	
A22	V _{SS}		C12	PEARN03		E2	V _{DD} CORE		F14	V _{DD} APE	
B1	V _{SS}		C13	V _{TT} PE		E3	V _{SS}		F15	V _{DD} PE	
B2	V _{SS}		C14	PEARP02		E4	V _{DD} CORE		F16	V _{SS}	
B3	V _{DD} CORE		C15	V _{TT} PE		E5	V _{SS}		F17	V _{SS}	
B4	V _{SS}		C16	PEARN01		E6	V _{SS}		F18	V _{DD} PE	
B5	PEATP07		C17	V _{SS}		E7	V _{TT} PE		F19	V _{SS}	
B6	V _{SS}		C18	PEARP00		E8	V _{DD} PE		F20	V _{SS}	
B7	PEATP06		C19	V _{SS}		E9	V _{DD} APE		F21	PECTP06	
B8	V _{SS}		C20	V _{DD} CORE		E10	V _{TT} PE		F22	PECTN06	
B9	PEATP05		C21	V _{DD} CORE		E11	V _{SS}		G1	V _{DD} CORE	
B10	V _{SS}		C22	V _{DD} CORE		E12	V _{DD} PE		G2	V _{DD} CORE	
B11	PEATP04		D1	V _{SS}		E13	V _{TT} PE		G3	V _{SS}	
B12	V _{SS}		D2	V _{SS}		E14	V _{SS}		G4	V _{DD} CORE	

Table 17 PES16NT2 484-pin Signal Pin-Out (Part 1 of 4)

Pin	Function	Alt	Pin	Function	Alt	Pin	Function	Alt	Pin	Function	Alt
G5	V _{SS}		H20	V _{SS}		K13	V _{DD} CORE		M6	V _{DD} CORE	
G6	V _{SS}		H21	PECTP05		K14	V _{SS}		M7	V _{SS}	
G7	V _{DD} IO		H22	PECTN05		K15	V _{DD} CORE		M8	V _{SS}	
G8	V _{SS}		J1	V _{SS}		K16	V _{SS}		M9	V _{DD} CORE	
G9	V _{SS}		J2	V _{DD} CORE		K17	V _{DD} APE		M10	V _{SS}	
G10	V _{SS}		J3	V _{SS}		K18	V _{SS}		M11	V _{DD} CORE	
G11	V _{DD} IO		J4	V _{DD} CORE		K19	V _{TT} PE		M12	V _{SS}	
G12	V _{SS}		J5	V _{SS}		K20	V _{TT} PE		M13	V _{DD} CORE	
G13	V _{SS}		J6	V _{DD} IO		K21	PECTN04		M14	V _{SS}	
G14	V _{DD} APE		J7	V _{SS}		K22	PECTP04		M15	V _{DD} CORE	
G15	V _{SS}		J8	V _{DD} CORE		L1	V _{SS}		M16	V _{SS}	
G16	V _{DD} IO		J9	V _{SS}		L2	V _{DD} CORE		M17	V _{DD} CORE	
G17	V _{DD} IO		J10	V _{DD} CORE		L3	V _{SS}		M18	V _{SS}	
G18	V _{SS}		J11	V _{SS}		L4	V _{DD} CORE		M19	V _{SS}	
G19	PECRP06		J12	V _{DD} CORE		L5	V _{SS}		M20	V _{SS}	
G20	PECRN06		J13	V _{SS}		L6	V _{DD} IO		M21	PECTP03	
G21	V _{SS}		J14	V _{DD} CORE		L7	V _{SS}		M22	PECTN03	
G22	V _{SS}		J15	V _{SS}		L8	V _{DD} CORE		N1	V _{SS}	
H1	V _{SS}		J16	V _{DD} APE		L9	V _{SS}		N2	V _{SS}	
H2	V _{SS}		J17	V _{SS}		L10	V _{DD} CORE		N3	V _{DD} CORE	
H3	V _{DD} CORE		J18	V _{DD} APE		L11	V _{SS}		N4	V _{DD} CORE	
H4	V _{SS}		J19	PECRN05		L12	V _{DD} CORE		N5	V _{DD} APE	
H5	V _{SS}		J20	PECRP05		L13	V _{SS}		N6	V _{DD} APE	
H6	V _{DD} CORE		J21	V _{SS}		L14	V _{DD} CORE		N7	V _{SS}	
H7	V _{SS}		J22	V _{SS}		L15	V _{SS}		N8	V _{DD} CORE	
H8	V _{DD} CORE		K1	V _{SS}		L16	V _{SS}		N9	V _{SS}	
H9	V _{SS}		K2	V _{SS}		L17	V _{DD} PE		N10	V _{DD} CORE	
H10	V _{DD} CORE		K3	V _{DD} CORE		L18	V _{DD} PE		N11	V _{SS}	
H11	V _{SS}		K4	V _{SS}		L19	PECRN04		N12	V _{DD} CORE	
H12	V _{SS}		K5	V _{SS}		L20	PECRP04		N13	V _{SS}	
H13	V _{DD} CORE		K6	V _{DD} CORE		L21	V _{SS}		N14	V _{DD} CORE	
H14	V _{SS}		K7	V _{SS}		L22	V _{SS}		N15	V _{SS}	
H15	V _{DD} CORE		K8	V _{SS}		M1	V _{SS}		N16	V _{SS}	
H16	V _{SS}		K9	V _{DD} CORE		M2	V _{SS}		N17	V _{DD} APE	
H17	V _{DD} PE		K10	V _{SS}		M3	V _{SS}		N18	V _{DD} APE	
H18	V _{TT} PE		K11	V _{DD} CORE		M4	V _{SS}		N19	PECRP03	
H19	V _{TT} PE		K12	V _{SS}		M5	V _{SS}		N20	PECRN03	

Table 17 PES16NT2 484-pin Signal Pin-Out (Part 2 of 4)

Pin	Function	Alt	Pin	Function	Alt	Pin	Function	Alt	Pin	Function	Alt
N21	V _{TT} PE		R14	V _{SS}		U7	V _{SS}		V22	PECTN00	
N22	V _{TT} PE		R15	V _{SS}		U8	V _{SS}		W1	V _{SS}	
P1	PEREFCLKP0		R16	V _{SS}		U9	V _{SS}		W2	V _{DD} CORE	
P2	PEREFCLKN0		R17	V _{DD} APE		U10	V _{SS}		W3	V _{SS}	
P3	V _{SS}		R18	V _{DD} APE		U11	V _{SS}		W4	V _{DD} CORE	
P4	V _{SS}		R19	PECRN02		U12	V _{SS}		W5	V _{SS}	
P5	V _{SS}		R20	PECRP02		U13	V _{SS}		W6	V _{DD} IO	
P6	V _{DD} IO		R21	V _{SS}		U14	V _{SS}		W7	V _{SS}	
P7	V _{SS}		R22	V _{SS}		U15	V _{SS}		W8	V _{DD} IO	
P8	V _{SS}		T1	V _{SS}		U16	V _{DD} CORE		W9	V _{DD} CORE	
P9	V _{DD} CORE		T2	V _{SS}		U17	V _{DD} CORE		W10	V _{SS}	
P10	V _{SS}		T3	V _{SS}		U18	V _{DD} CORE		W11	V _{DD} IO	
P11	V _{DD} CORE		T4	V _{SS}		U19	PECRP01		W12	V _{SS}	
P12	V _{SS}		T5	V _{SS}		U20	PECRN01		W13	V _{SS}	
P13	V _{DD} CORE		T6	V _{DD} IO		U21	V _{DD} PE		W14	V _{DD} IO	
P14	V _{SS}		T7	V _{DD} IO		U22	V _{TT} PE		W15	V _{SS}	
P15	V _{DD} CORE		T8	V _{DD} IO		V1	V _{DD} CORE		W16	V _{DD} IO	
P16	V _{SS}		T9	V _{DD} CORE		V2	V _{SS}		W17	V _{SS}	
P17	V _{DD} PE		T10	V _{DD} IO		V3	V _{DD} CORE		W18	V _{SS}	
P18	V _{DD} PE		T11	V _{DD} CORE		V4	V _{SS}		W19	PECRN00	
P19	V _{SS}		T12	V _{DD} CORE		V5	V _{SS}		W20	PECRP00	
P20	V _{SS}		T13	V _{DD} IO		V6	V _{SS}		W21	V _{SS}	
P21	PECTP02		T14	V _{DD} IO		V7	V _{DD} CORE		W22	V _{SS}	
P22	PECTN02		T15	V _{DD} CORE		V8	V _{SS}		Y1	V _{DD} CORE	
R1	V _{SS}		T16	V _{DD} IO		V9	V _{SS}		Y2	V _{SS}	
R2	V _{SS}		T17	V _{DD} IO		V10	V _{DD} CORE		Y3	V _{DD} CORE	
R3	V _{DD} CORE		T18	V _{SS}		V11	V _{SS}		Y4	V _{DD} CORE	
R4	V _{DD} CORE		T19	V _{SS}		V12	V _{DD} CORE		Y5	JTAG_TDO	
R5	V _{SS}		T20	V _{DD} APE		V13	V _{SS}		Y6	MSMBADDR_1	
R6	V _{DD} CORE		T21	PECTP01		V14	V _{DD} CORE		Y7	MSMBADDR_4	
R7	V _{SS}		T22	PECTN01		V15	V _{SS}		Y8	SSMBADDR_1	
R8	V _{SS}		U1	V _{SS}		V16	V _{DD} CORE		Y9	SSMBADDR_5	
R9	V _{SS}		U2	V _{SS}		V17	V _{SS}		Y10	CCLKUS	
R10	V _{SS}		U3	V _{SS}		V18	V _{DD} CORE		Y11	CCLKDS	
R11	V _{SS}		U4	V _{DD} CORE		V19	V _{DD} PE		Y12	PEALREV	
R12	V _{SS}		U5	V _{SS}		V20	V _{TT} PE		Y13	SWMODE_1	
R13	V _{SS}		U6	V _{SS}		V21	PECTP00		Y14	PECLREV	

Table 17 PES16NT2 484-pin Signal Pin-Out (Part 3 of 4)

Pin	Function	Alt	Pin	Function	Alt	Pin	Function	Alt	Pin	Function	Alt
Y15	RSTHALT		AA6	JTAG_TRST_N		AA19	REFCLKM		AB10	SSMBCLK	
Y16	GPIO_02	1	AA7	MSMBADDR_3		AA20	V _{DD} CORE		AB11	V _{SS}	
Y17	GPIO_05	1	AA8	MSMBDAT		AA21	V _{SS}		AB12	V _{SS}	
Y18	MSMBSMODE		AA9	SSMBADDR_3		AA22	V _{SS}		AB13	V _{SS}	
Y19	V _{SS}		AA10	SSMBDAT		AB1	V _{SS}		AB14	SWMODE_2	
Y20	V _{SS}		AA11	V _{SS}		AB2	V _{SS}		AB15	PERSTN	
Y21	PEREFCLKP1		AA12	V _{DD} CORE		AB3	V _{SS}		AB16	GPIO_00	
Y22	PEREFCLKN1		AA13	SWMODE_0		AB4	V _{SS}		AB17	GPIO_03	
AA1	V _{SS}		AA14	SWMODE_3		AB5	JTAG_TCK		AB18	GPIO_06	
AA2	V _{SS}		AA15	PENTBRSTN		AB6	JTAG_TMS		AB19	V _{SS}	
AA3	V _{DD} CORE		AA16	GPIO_01	1	AB7	MSMBADDR_2		AB20	V _{SS}	
AA4	V _{DD} CORE		AA17	GPIO_04	1	AB8	SSMBCLK		AB21	V _{SS}	
AA5	JTAG_TDI		AA18	GPIO_07		AB9	SSMBADDR_2		AB22	V _{SS}	

Table 17 PES16NT2 484-pin Signal Pin-Out (Part 4 of 4)

Alternate Signal Functions

Pin	GPIO	Alternate
AA16	GPIO_1	PECRSTN
Y16	GPIO_2	PALINKUPN
AA17	GPIO_4	PCLINKUPN
Y17	GPIO_5	FAILOVERP

Table 18 PES16NT2 Alternate Signal Functions

Power Pins

V_{DDCore}	V_{DDCore}	V_{DDCore}	V_{DDCore}	V_{DDIO}	V_{DDPE}	V_{DDAPE}	V_{TTPE}
A3	J2	M13	U16	F6	D11	E9	C13
B3	J4	M15	U17	G7	E8	F9	C15
C1	J8	M17	U18	G11	E12	F10	D7
C2	J10	N3	V1	G16	E16	F13	D9
C3	J12	N4	V3	G17	F8	F14	E7
C20	J14	N8	V7	J6	F11	G14	E10
C21	K3	N10	V10	L6	F12	J16	E13
C22	K6	N12	V12	P6	F15	J18	E15
E1	K9	N14	V14	T6	F18	K17	H18
E2	K11	P9	V16	T7	H17	N5	H19
E4	K13	P11	V18	T8	L17	N6	K19
F3	K15	P13	W2	T10	L18	N17	K20
G1	L2	P15	W4	T13	P17	N18	N21
G2	L4	R3	W9	T14	P18	R17	N22
G4	L8	R4	Y1	T16	U21	R18	U22
H3	L10	R6	Y3	T17	V19	T20	V20
H6	L12	T9	Y4	W6			
H8	L14	T11	AA3	W8			
H10	M6	T12	AA4	W11			
H13	M9	T15	AA12	W14			
H15	M11	U4	AA20	W16			

Table 19 PES16TN2 Power Pins

Ground Pins

V _{SS}	V _{SS}	V _{SS}	V _{SS}	V _{SS}	V _{SS}	V _{SS}
A1	D2	G13	K10	N9	T3	W10
A2	D3	G15	K12	N11	T4	W12
A4	D5	G18	K14	N13	T5	W13
A6	D13	G21	K16	N15	T18	W15
A8	D15	G22	K18	N16	T19	W17
A10	D17	H1	L1	P3	U1	W18
A12	D19	H2	L3	P4	U2	W21
A14	D20	H4	L5	P5	U3	W22
A16	E3	H5	L7	P7	U5	Y2
A18	E5	H7	L9	P8	U6	Y19
A20	E6	H9	L11	P10	U7	Y20
A21	E11	H11	L13	P12	U8	AA1
A22	E14	H12	L15	P14	U9	AA2
B1	E17	H14	L16	P16	U10	AA11
B2	E18	H16	L21	P19	U11	AA21
B4	E21	H20	L22	P20	U12	AA22
B6	E22	J1	M1	R1	U13	AB1
B8	F1	J3	M2	R2	U14	AB2
B10	F2	J5	M3	R5	U15	AB3
B12	F4	J7	M4	R7	V2	AB4
B14	F5	J9	M5	R8	V4	AB11
B16	F7	J11	M7	R9	V5	AB12
B18	F16	J13	M8	R10	V6	AB13
B20	F17	J15	M10	R11	V8	AB19
B21	F19	J17	M12	R12	V9	AB20
B22	F20	J21	M14	R13	V11	AB21
C5	G3	J22	M16	R14	V13	AB22
C7	G5	K1	M18	R15	V15	
C9	G6	K2	M19	R16	V17	
C11	G8	K4	M20	R21	W1	
C17	G9	K5	N1	R22	W3	
C19	G10	K7	N2	T1	W5	
D1	G12	K8	N7	T2	W7	

Table 20 PES16NT2 Ground Pins

Signals Listed Alphabetically

Signal Name	I/O Type	Location	Signal Category	
CCLKDS	I	Y11	System	
CCLKUS	I	Y10		
GPIO_00	I/O	AB16	General Purpose Input/Output	
GPIO_01	I/O	AA16		
GPIO_02	I/O	Y16		
GPIO_03	I/O	AB17		
GPIO_04	I/O	AA17		
GPIO_05	I/O	Y17		
GPIO_06	I/O	AB18		
GPIO_07	I/O	AA18		
JTAG_TCK	I	AB05		JTAG
JTAG_TDI	I	AA05		
JTAG_TDO	O	Y5		
JTAG_TMS	I	AB6		
JTAG_TRST_N	I	AA6		
MSMBADDR_1	I	Y6	SMBus	
MSMBADDR_2	I	AB7		
MSMBADDR_3	I	AA7		
MSMBADDR_4	I	Y7		
MSMBCLK	I/O	AB8		
MSMBDAT	I/O	AA8		
MSMBSMODE	I	Y18	System	
PEALREV	I	Y12	PCI Express	
PEARN00	I	D18		
PEARN01	I	C16		
PEARN02	I	D14		
PEARN03	I	C12		
PEARN04	I	C10		
PEARN05	I	D8		
PEARN06	I	C6		
PEARN07	I	D4		
PEARP00	I	C18		
PEARP01	I	D16		
PEARP02	I	C14		

Table 21 89PES16NT2 Alphabetical Signal List (Part 1 of 4)

Signal Name	I/O Type	Location	Signal Category
PEARP03	I	D12	PCI Express (cont.)
PEARP04	I	D10	
PEARP05	I	C8	
PEARP06	I	D6	
PEARP07	I	C4	
PEATN00	O	A19	
PEATN01	O	B17	
PEATN02	O	A15	
PEATN03	O	B13	
PEATN04	O	A11	
PEATN05	O	A9	
PEATN06	O	A7	
PEATN07	O	A5	
PEATP00	O	B19	
PEATP01	O	A17	
PEATP02	O	B15	
PEATP03	O	A13	
PEATP04	O	B11	
PEATP05	O	B9	
PEATP06	O	B7	
PEATP07	O	B5	
PECLREV	I	Y14	
PECRN00	I	W19	
PECRN01	I	U20	
PECRN02	I	R19	
PECRN03	I	N20	
PECRN04	I	L19	
PECRN05	I	J19	
PECRN06	I	G20	
PECRN07	I	E19	
PECRP00	I	W20	
PECRP01	I	U19	
PECRP02	I	R20	
PECRP03	I	N19	
PECRP04	I	L20	
PECRP05	I	J20	

Table 21 89PES16NT2 Alphabetical Signal List (Part 2 of 4)

Signal Name	I/O Type	Location	Signal Category
PECRP06	I	G19	PCI Express (cont.
PECRP07	I	E20	
PECTN00	O	V22	
PECTN01	O	T22	
PECTN02	O	P22	
PECTN03	O	M22	
PECTN04	O	K21	
PECTN05	O	H22	
PECTN06	O	F22	
PECTN07	O	D22	
PECTP00	O	V21	
PECTP01	O	T21	
PECTP02	O	P21	
PECTP03	O	M21	
PECTP04	O	K22	
PECTP05	O	H21	
PECTP06	O	F21	
PECTP07	O	D21	
PENTBRSTN	I	AA15	
PEREFCLKN0	I	P2	PCI Express
PEREFCLKN1	I	Y22	
PEREFCLKP0	I	P1	
PEREFCLKP1	I	Y21	
PERSTN	I	AB15	System
REFCLKM	I	AA19	PCI Express
RSTHALT	I	Y15	System
SSMBADDR_1	I	Y8	SMBus
SSMBADDR_2	I	AB9	
SSMBADDR_3	I	AA9	
SSMBADDR_5	I	Y9	
SSMBCLK	I/O	AB10	
SSMBDAT	I/O	AA10	

Table 21 89PES16NT2 Alphabetical Signal List (Part 3 of 4)

Signal Name	I/O Type	Location	Signal Category
SWMODE_0	I	AA13	System
SWMODE_1	I	Y13	
SWMODE_2	I	AB14	
SWMODE_3	I	AA14	
V _{DD} CORE, V _{DD} APE, V _{DD} IO, V _{DD} PE, V _{TT} PE	See Table 19 for a listing of power pins.		
V _{SS}	See Table 20 for a listing of ground pins.		

Table 21 89PES16NT2 Alphabetical Signal List (Part 4 of 4)

PES16NT2 Pinout — Top View

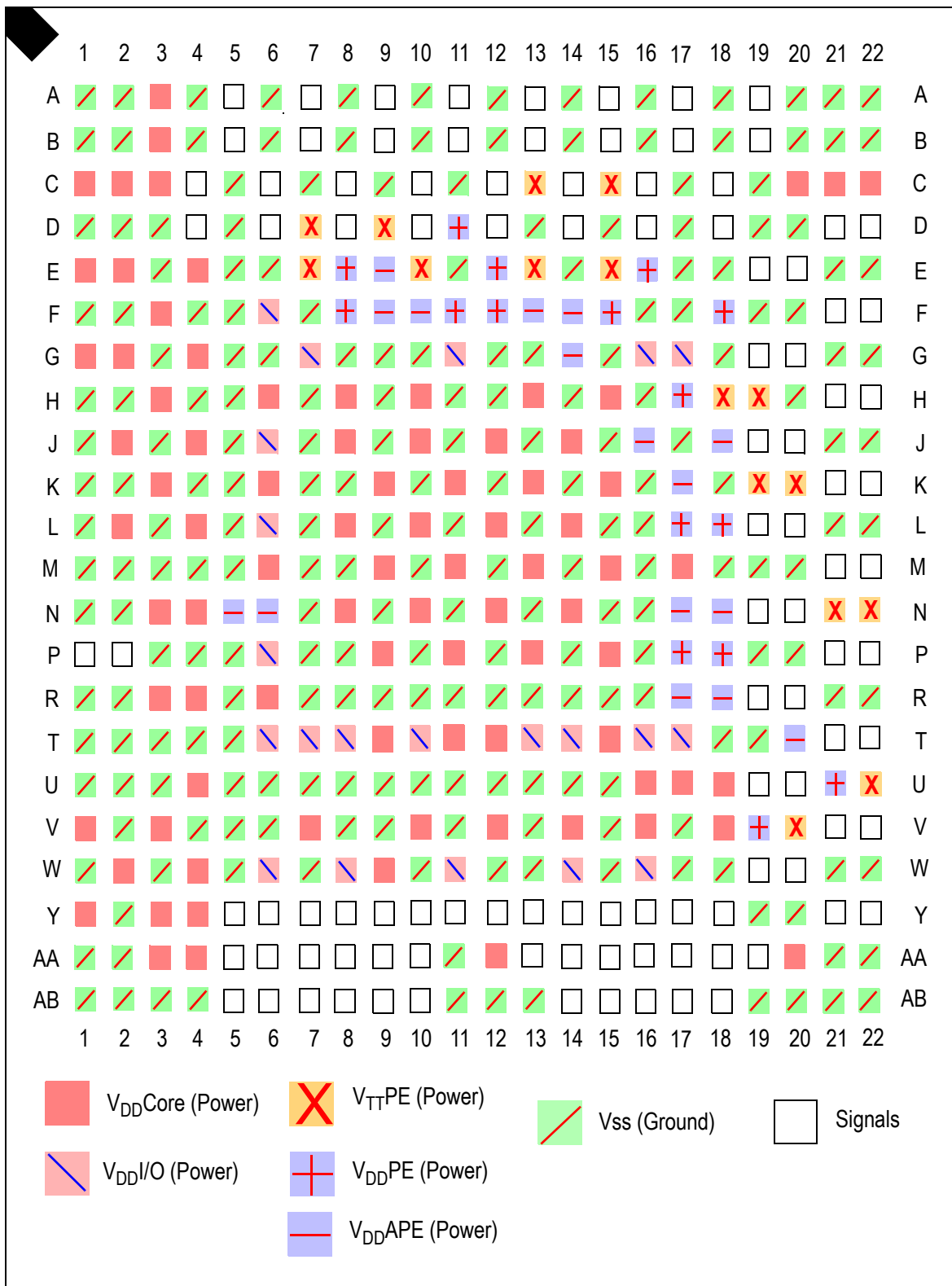

PES16NT2 Package Drawing — 484-Pin BC484/BCG484

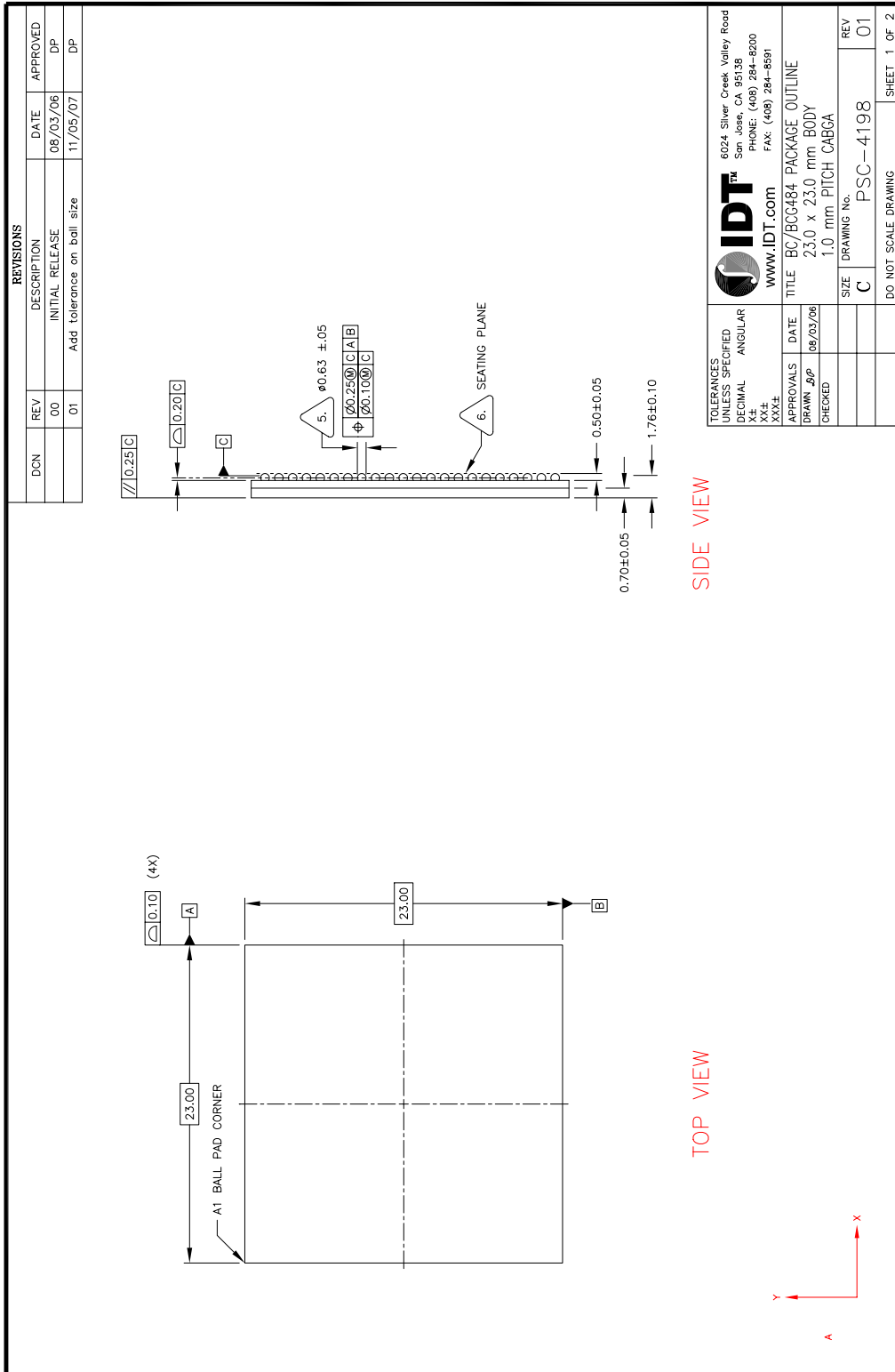

PES16NT2 Package Drawing — Page Two

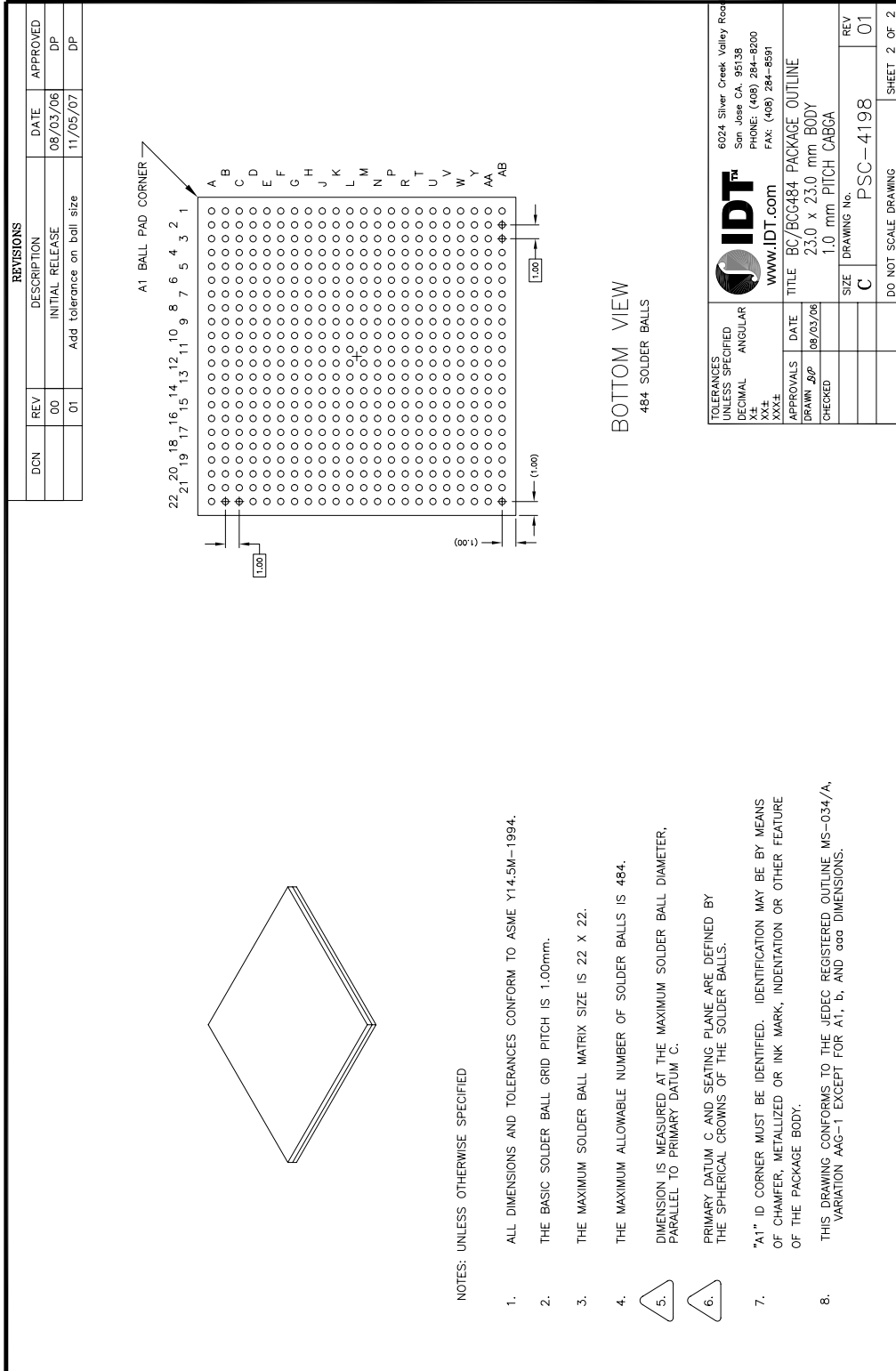

Revision History

April 15, 2008: Initial publication of data sheet.

January 5, 2009: On the Ordering Information page, changed silicon revision from ZA to ZB.

Ordering Information

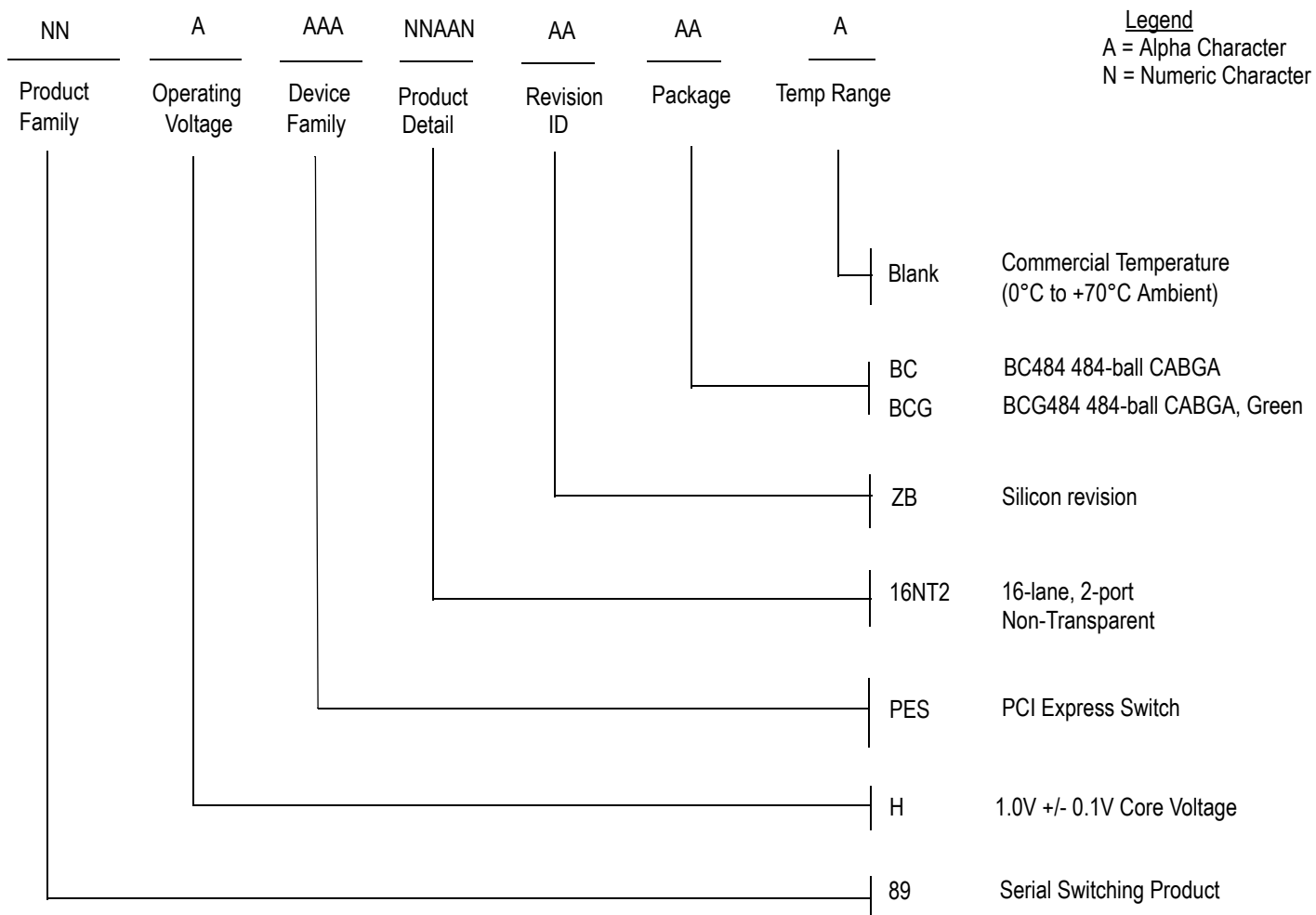

Legend

A = Alpha Character
N = Numeric Character

Valid Combinations

- 89HPES16NT2ZBBC 484-ball CABGA package, Commercial Temperature
- 89HPES16NT2ZBBCG 484-ball Green CABGA package, Commercial Temperature

IMPORTANT NOTICE AND DISCLAIMER

RENESAS ELECTRONICS CORPORATION AND ITS SUBSIDIARIES (“RENESAS”) PROVIDES TECHNICAL SPECIFICATIONS AND RELIABILITY DATA (INCLUDING DATASHEETS), DESIGN RESOURCES (INCLUDING REFERENCE DESIGNS), APPLICATION OR OTHER DESIGN ADVICE, WEB TOOLS, SAFETY INFORMATION, AND OTHER RESOURCES “AS IS” AND WITH ALL FAULTS, AND DISCLAIMS ALL WARRANTIES, EXPRESS OR IMPLIED, INCLUDING, WITHOUT LIMITATION, ANY IMPLIED WARRANTIES OF MERCHANTABILITY, FITNESS FOR A PARTICULAR PURPOSE, OR NON-INFRINGEMENT OF THIRD PARTY INTELLECTUAL PROPERTY RIGHTS.

These resources are intended for developers skilled in the art designing with Renesas products. You are solely responsible for (1) selecting the appropriate products for your application, (2) designing, validating, and testing your application, and (3) ensuring your application meets applicable standards, and any other safety, security, or other requirements. These resources are subject to change without notice. Renesas grants you permission to use these resources only for development of an application that uses Renesas products. Other reproduction or use of these resources is strictly prohibited. No license is granted to any other Renesas intellectual property or to any third party intellectual property. Renesas disclaims responsibility for, and you will fully indemnify Renesas and its representatives against, any claims, damages, costs, losses, or liabilities arising out of your use of these resources. Renesas' products are provided only subject to Renesas' Terms and Conditions of Sale or other applicable terms agreed to in writing. No use of any Renesas resources expands or otherwise alters any applicable warranties or warranty disclaimers for these products.

(Disclaimer Rev.1.0 Mar 2020)

Corporate Headquarters

TOYOSU FORESIA, 3-2-24 Toyosu,
Koto-ku, Tokyo 135-0061, Japan
www.renesas.com

Contact Information

For further information on a product, technology, the most up-to-date version of a document, or your nearest sales office, please visit:
www.renesas.com/contact/

Trademarks

Renesas and the Renesas logo are trademarks of Renesas Electronics Corporation. All trademarks and registered trademarks are the property of their respective owners.