



# **ORIENT DISPLAY**

Your Total LCD Solution Provider

## Specification for TFT

### **AFC7201280A0-5.0INTM-I**

Revision C



A	Orient Display
FC	TFT Type
7201280	Resolution 720 x 1280
A0	Serial A0
5.0	5.0", Module Dimension 65.3 x 118.782 x 1.64 mm
I	IPS Display
N	Top: -20~+70°C; Tstr: -30~+80°C
T	Transmissive
M	Medium Brightness, 350 cd/m2
I	MIPI Interface
/	No Touch Panel
/	Controller ST7703I Or Compatible



## Revision History

<b>Date</b>	<b>Rev.</b>	<b>Description</b>	<b>Note</b>	<b>Page</b>
<b>2019.10.18</b>	<b>A</b>	<b>New issue</b>		
<b>2020.11.24</b>	<b>B</b>	<b>Update Quality Assurance</b>	<b>LT</b>	<b>16/17</b>
<b>2021.01.22</b>	<b>C</b>	<b>Update Count Drawing</b>	<b>LT</b>	<b>11</b>

## Contents

1. Features.....	4
2. Mechanical Specifications.....	4
3. Absolute Maximum Ratings.....	4
4. DC Electrical Characteristics.....	5
5. Optical Characteristics.....	5
6. Backlight Characteristics.....	9
7. Interface Pin Description.....	9
8. Block Diagram of Display.....	10
9. Count Drawing.....	11
10. FPC Layout.....	12
11. Timing Characteristics.....	13
12. Reliability.....	13
13. Quality Assurance.....	14

## 1. Features

Item	Standard Value
Display Type	720(RGB)*1280 Dots
LCD Type	Color TFT, Transmissive, Normal Black
Screen Size(inch)	5''
Viewing Direction	Free
Weight	28.4g
Interface	MIPI
Other(controller/driver IC)	ST7703I

## 2. Mechanical Specifications

Item	Standard Value	Unit
Outline Dimension	65.3(L)*118.782(W)*1.64(T)	mm
Active Area	62.1(L)*110.402(W)	mm
Dots Pitch	0.08625(H) ×0.08625(V)	mm

## 3. Absolute Maximum Ratings

Item	Symbol	Condition	Min.	Max.	Unit
Power Supply Voltage(Analog)	V <sub>DDA</sub>	-	-0.3	3.6	V
Power Supply Voltage(I/O)	V <sub>DDI</sub>	-	-0.3	2.0	V
Operating Temperature	T <sub>OP</sub>	-	-20	70	°C
Storage Temperature	T <sub>ST</sub>	-	-30	80	°C
Humidity	-	T <sub>A</sub> ≤ 40°C	-	90	RH

#### 4. DC Electrical Characteristics

Item	Symbol	Condition	Min.	Typ.	Max.	Unit
System Voltage	V <sub>DDA</sub>	Operating Voltage	3.0	3.3	3.4	V
Interface Voltage	V <sub>DDI</sub>	I/O Supply Voltage	1.65	1.8	2.0	V
“H” Input Voltage	V <sub>IH</sub>	-	0.7V <sub>DDI</sub>	--	V <sub>DDI</sub>	V
“L” Input Voltage	V <sub>IL</sub>	-	V <sub>SS</sub>	--	0.3V <sub>DDI</sub>	V
“H” Output Voltage	V <sub>OH</sub>	I <sub>OH</sub> = -1.0mA	0.8V <sub>DDI</sub>	--	V <sub>DDI</sub>	V
“L” Output Voltage	V <sub>OL</sub>	I <sub>OL</sub> = +1.0mA	V <sub>SS</sub>	--	0.2V <sub>DDI</sub>	V
Supply Current(Image RED)	I <sub>DD</sub>	Normal	--	27	36	mA
		Stand-by	--	--	--	uA
TFT gate on voltage	V <sub>GH</sub>	--	17.5	18	18.5	V
TFT gate off voltage	V <sub>GL</sub>	--	-10.5	-10	-9.5	V
TFT common electrode voltage	V <sub>com</sub>	-	--	-1.53	--	V

#### 5. Optical Characteristics

Item	Symbol	Conditions	Min.	Typ.	Max.	Reference	
View Angle	Top	C <sub>≥</sub> 10	-	80	-	Notes 1 & 2	
	Bottom		-	80	-		
	Left		-	80	-		
	Right		-	80	-		
CIE *1	White	TA=25° Θ <sub>x</sub> , Θ <sub>Y</sub> =0°	X	0.247	0.287	0.327	Notes 5
			Y	0.283	0.323	0.363	
	Red		X	0.599	0.639	0.679	
			Y	0.301	0.341	0.381	
	Green		X	0.286	0.326	0.366	
			Y	0.565	0.605	0.645	
	Blue		X	0.1048	0.1448	0.1848	
			Y	0.017	0.057	0.097	
Uniformity			70%	-	-	Note 4	
Contrast Ratio	Cr	θ <sub>Y</sub> = 5°, Ø = 0°	600	1000	-	Note 3	
Surface Brightness of white	L	Ø = 0°	250cd/m <sup>2</sup>	350cd/m <sup>2</sup>	-	Note 3 & 4	
NTSC	-		-	70%	-	-	
Response Time	TR+TF	Ø = 0°	-	25ms	35ms	Note 2	

Note 1.

Optical characteristics-2

Viewing angle

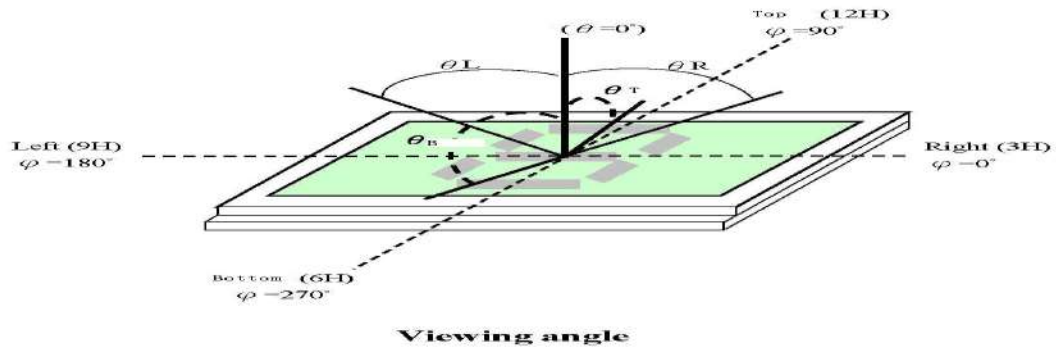

Note 2.

Optical characteristics-3

Fig.2 Definition of response time

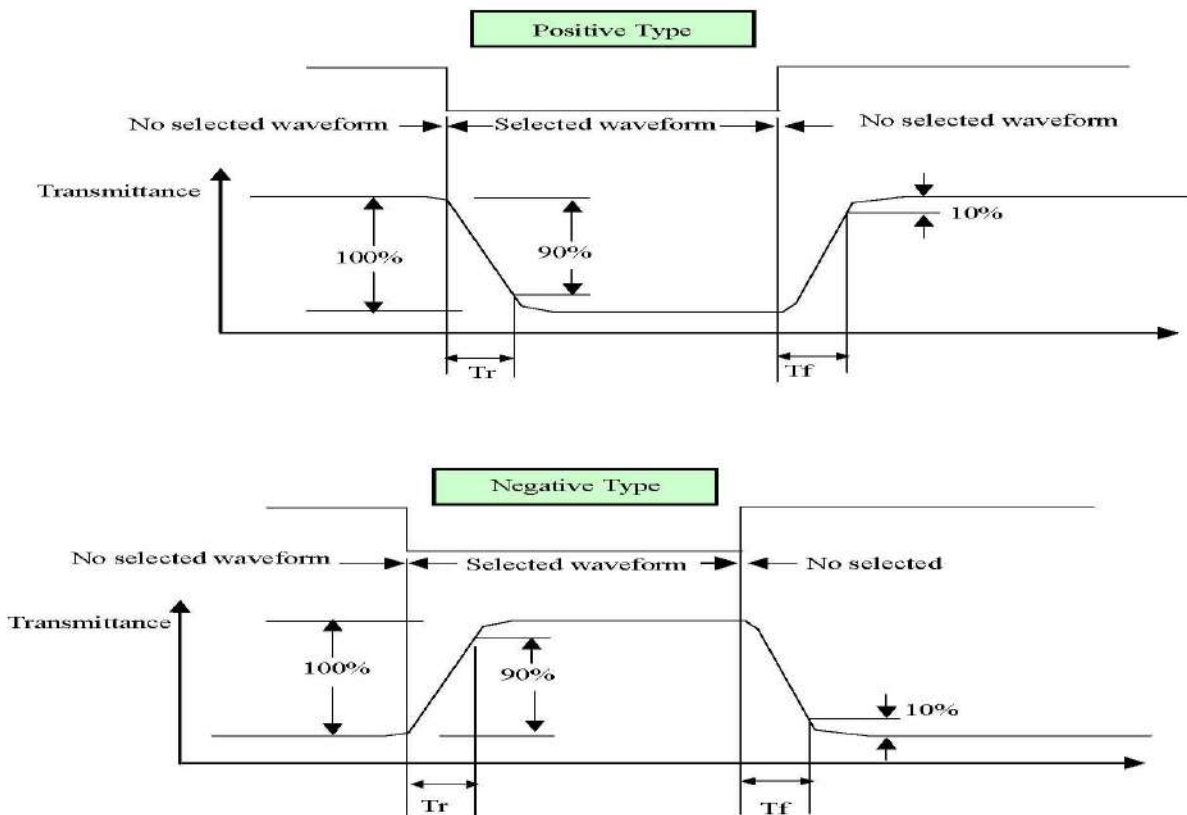

Electrical characteristics-2

※2 Drive waveform

$V_{op}$ : Drive voltage       $f_F$ : Frame frequency

$1/B$ : Bias                       $f_D$ : Drive frequency

$N$ : Duty

(1) Selected waveform

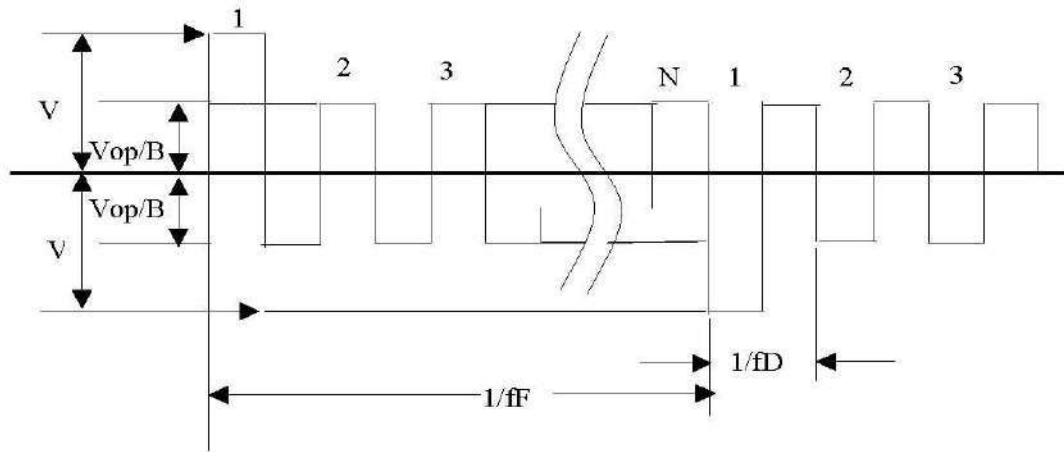

(2) Non- Selected wave form

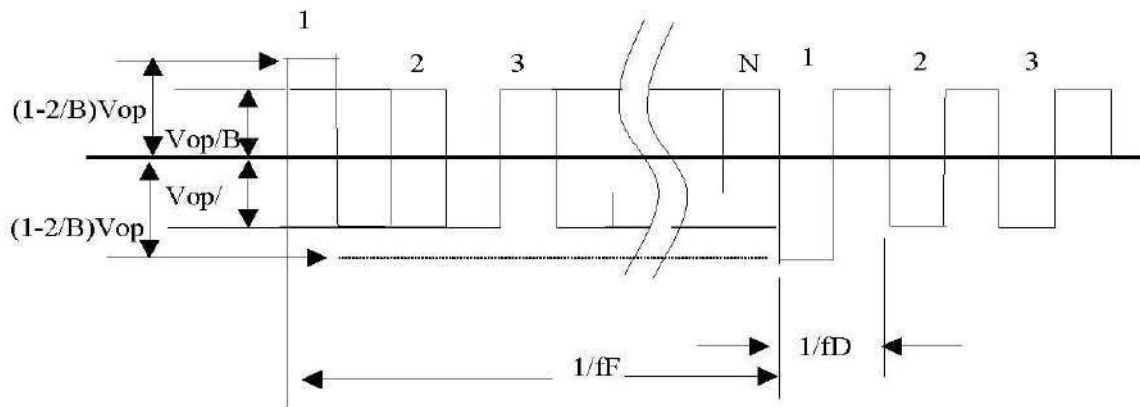

Note:

Frame frequency is defined as follows: Common side supply voltage peak - to - peak / 2 = 1 period

Note 3. : Definition of Vth

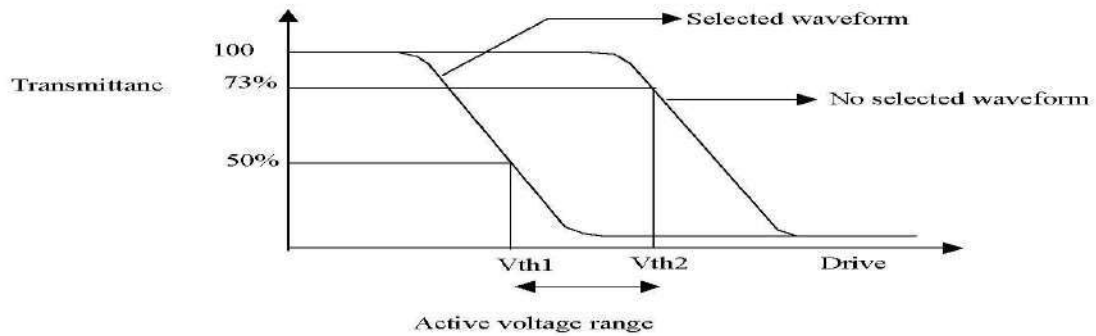

	Vth1	Vth2
View direction	10°	40°
Drive waveform	(Selected waveform)	(No selected waveform)
Transmittance	50%	73%

※1 Contrast ratio  
 = (Brightness in OFF state) / (Brightness in ON state)

Outline of Electro-Optical Characteristics Measuring System

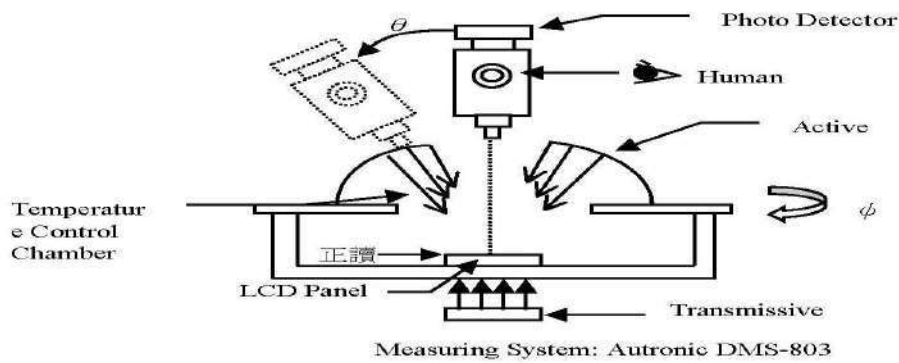

Note 4. Definition of Surface Luminance, Uniformity. (Ref Fig1)

Surface Luminance: LV=average (LP1:LP9)

Uniformity=Minimal (LP1:LP9)/Maximal (LP1:LP9)\*100%

Color Coordinate: The test condition is at IF current of backlight and measured on the surface of LCD module.

Note 5. CIE(x, y) chromaticity is the Center point value. (Ref Fig1)

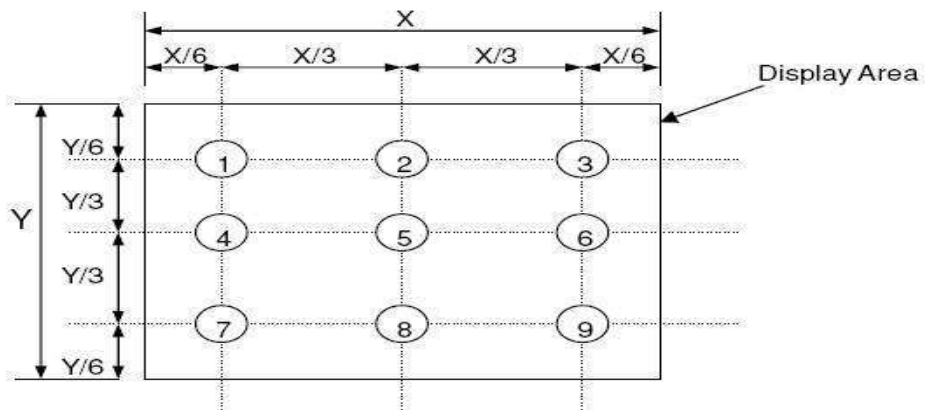

Fig1



## 6. Backlight Characteristics

Item	Symbol	Conditions	Min.	Typ.	Max.	Unit
Forward Voltage(12 LED)	$V_F$		16.8	19.2	20.4	V
Forward Current	$I_F$		--	40	--	mA
LED Life time (50% initial brightness)		$T_a=25^{\circ}\text{C}$ , $I_F=40\text{ mA}$	30000H minimum			
Color	WHITE					

## 7. Interface Pin Description

Pin No.	Symbol	Function
1、 2	LEDA	LED back light(Anode)
3~6	NC	NC
7、 8	LEDK	LED back light(Cathode)
9	RESET	Reset Signal input pin.
10	GND	Ground.
11	DSI_D3+	MIPI-DSI Data differential signal input pins.
12	DSI_D3-	
13	GND	Ground.
14	DSI_D2+	MIPI-DSI Data differential signal input pins.
15	DSI_D2-	
16	GND	Ground.
17	DSI_CLK+	MIPI-DSI Data differential signal input pins.
18	DSI_CLK-	
19	GND	Ground.
20	DSI_D1+	MIPI-DSI Data differential signal input pins.
21	DSI_D1-	
22	GND	Ground.
23	DSI_D0+	MIPI-DSI Data differential signal input pins.
24	DSI_D0-	
25	GND	Ground.
26、 27	NC	NC
28、 29	VDD_3V3	Analog Power Supply (3.3 Typ)
30	VCC_1V8	DSI and IO Power Supply (1.8V Typ)

## 8. Block Diagram of Display



# 9. Count Drawing

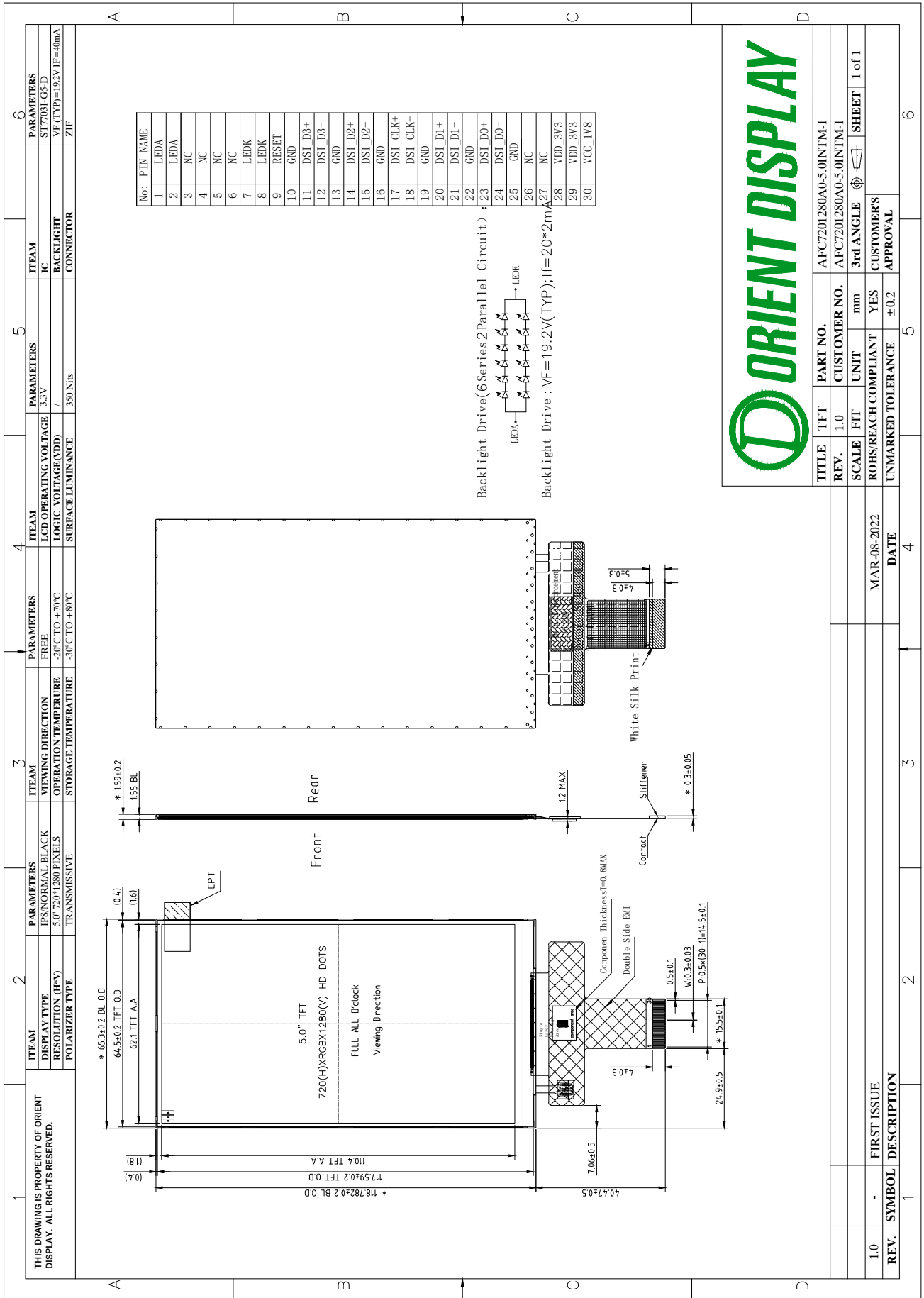

TITLE	TFT	PART NO.	AFC7201280A0-5.0INTM-1
REV.	1.0	CUSTOMER NO.	AFC7201280A0-5.0INTM-1
SCALE	FIT	UNIT	mm
ROHS/REACH COMPLIANT	YES	CUSTOMER'S APPROVAL	3rd ANGLE
UNMARKED TOLERANCE	±0.2	SHEET	1 of 1

REV.	SYMBOL	DESCRIPTION	DATE
1.0	-	FIRST ISSUE	MAR-08-2022

## 10. FPC Layout

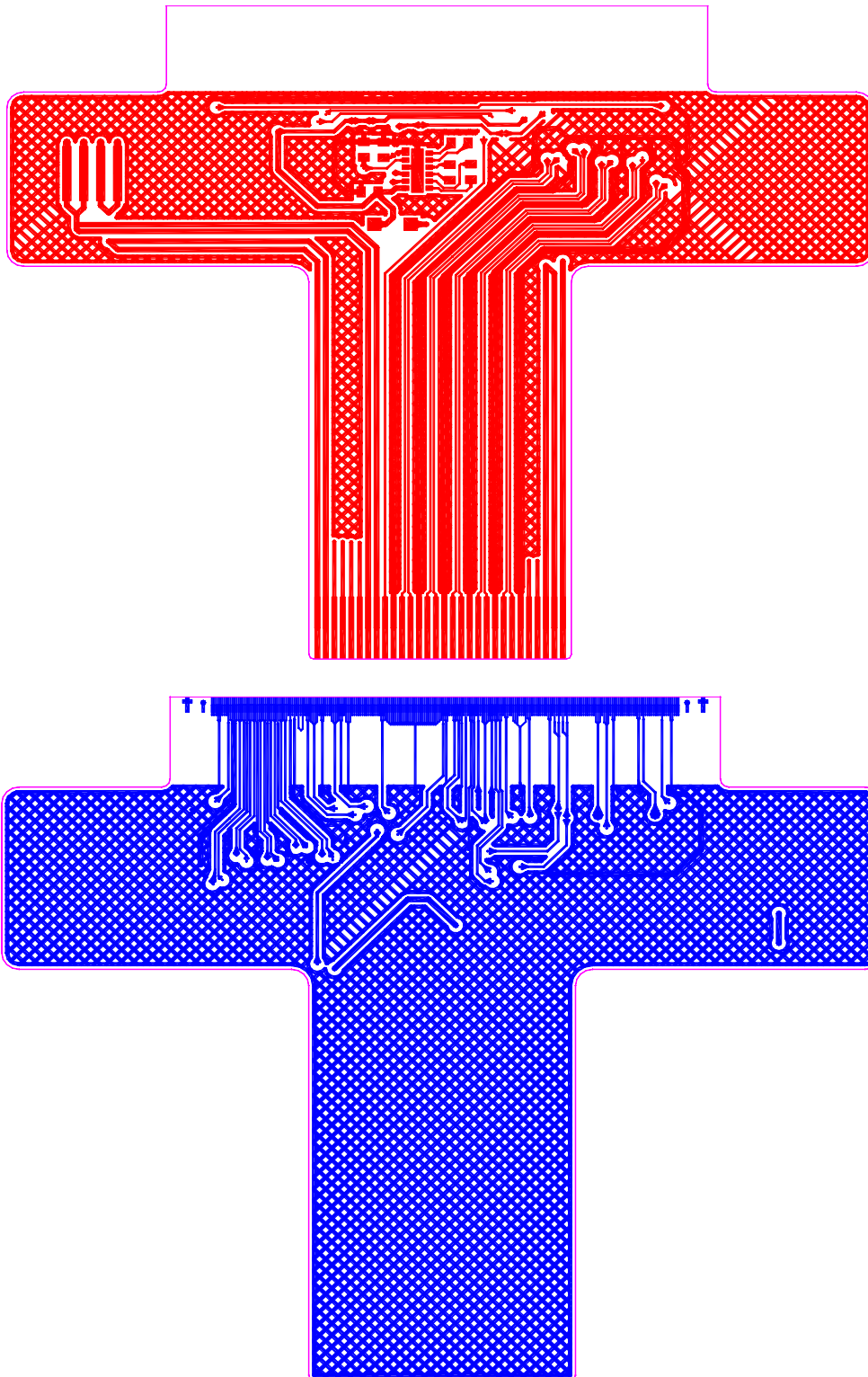

## 11. Timing Characteristics

Please references ST7703 datasheet.

## 12. Reliability

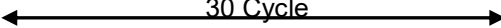
NO	Item	Test Condition
1	High Temperature Storage	Storage at $70 \pm 2^\circ\text{C}$ 120 hrs Surrounding temperature, then storage at normal condition 4hrs
2	Low Temperature Storage	Storage at $-20 \pm 2^\circ\text{C}$ 120 hrs Surrounding temperature, then storage at normal condition 4hrs
3	High Temperature Operation	Operation at $70 \pm 2^\circ\text{C}$ 120 hrs
4	Low Temperature Operation	Operation at $-10 \pm 2^\circ\text{C}$ 120 hrs
5	High Temperature /Humidity Operating	Operation at $40 \pm 2^\circ\text{C}$ , 90%RH 120 hrs surrounding temperature, then storage at normal condition 4hrs.
6	Thermal shock (non-operation)	$-20^\circ\text{C} \rightarrow 25^\circ\text{C} \rightarrow 70^\circ\text{C} \rightarrow 25^\circ\text{C}$ (60mins) (5mins) (60mins) (5mins)  30 Cycle
7	Mechanical Test	Freq.: 10-55Hz Max. Acceleration: 5G X.Y.X. each direction For 10 mines.
		Drop them through 50cm height to strike horizontal plane
8	ESD Test	Air Discharge: Apply +/-6KV with 5 times Discharge for each polarity +/-
		Contact Discharge: Apply +/-4KV with 5 times Discharge for each polarity +/-
1. Temperature ambience: $15^\circ\text{C} \sim 35^\circ\text{C}$ 2. Humidity relative: 30%~60% 3. Energy Storage Capacitance(Cs+Cd): 150pF+/-10% 4. Discharge Resistance(Rd): $330\Omega$ +/-10% 5. Discharge, mode of operation: Single Discharge (time between successive discharges at least 1 sec) (Tolerance if the output voltage indication: +/-5%)		

Note 1. For humidity test, DI water should be used

Inspection Standard: Inspect after 1-2hrs storage at room temperature, the sample shall be free from the following defects:

- Air bubble in the LCD
- Seal Leakage
- Non-display
- Missing Segment
- Glass Crack
- IDD is greater than twice initial value
- Others as per QA Inspection Criteria

Note 2. No defect is allowed after testing.

Note 3. ESD should be applied to LCD glass panel, not other areas (such as on IC and so on)  
IDD should be within twice initial value.

In case of malfunction defect caused by ESD damage, if it would be recovered to normal state after resetting, it would be judged as a good part.

Note 4. Only upon request.

## 13. Quality Assurance

### 13.1. Purpose

This standard for Quality Assurance assures the quality of LCD module products supplied to customer by ODNA.

### 13.2. Standard for Quality Test

ODNA performs the following tests to ensure the quality of product before shipment.

#### 13.2.1 Sampling Plan:

GB/T2828.1-2003. Single sampling, General Inspection Level II .  
Single sampling, normal inspection

#### 13.2.2 Sampling Criteria:

Minor Defect: AQL 0.65%  
Major Defect: AQL 0.15%

#### 13.2.3 Defect class defining:

Minor Defect: Not Impact function of product;  
Major Defect: Impact the function of product;  
Critical Defect: Impact safety, or not conformity with law.

#### 13.2.4 Reliability Test:

Detailed requirement refer to Reliability Test Specification.

#### 13.2.5 Nonconforming Analysis & Disposition

#### 13.2.6 Nonconforming analysis

Customer should provide overall information of non-conforming sample for their complaints.

13.2.6.1 After receipt of detailed information from customer, the analysis of nonconforming parts usually should be finished in one week.

13.2.6.2 If ODNA can not finish the analysis on time, customer will be notified with the progress status.

13.2.6.3 Disposition of nonconforming:

13.2.6.4 Non-conforming product over ppm level will be replaced.

13.2.6.5 The cause of non-conformance will be analyzed. Corrective action will be discussed

13.3. and implemented. Agreement Items

ODNA and customer shall negotiate if the following situation occurs

- 13.3.1 There is any discrepancy in standard of quality assurance.
- 13.3.2 Additional requirement to be added in product specification.
- 13.3.3 Any other special problem.

13.4. Standard of the Product Visual Inspection

13.4.1 Appearance inspection

- 13.4.1.1 The normal inspection must be under illumination no less than 800lux, and the distance of view must be between 30cm and 45cm;
- 13.4.1.2 When inspect the model of transmissive product, back light must be lighted.
- 13.4.1.3 The visual viewing angle should be 45° from the vertical line without reflection shine or follows customer's viewing angle specifications.

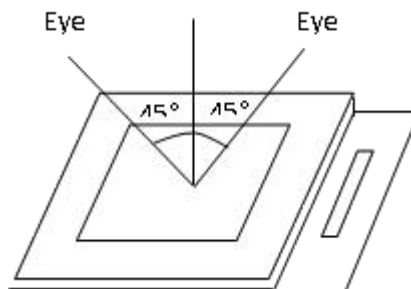

13.4.1.4 Definition of area :( refer to product drawing)

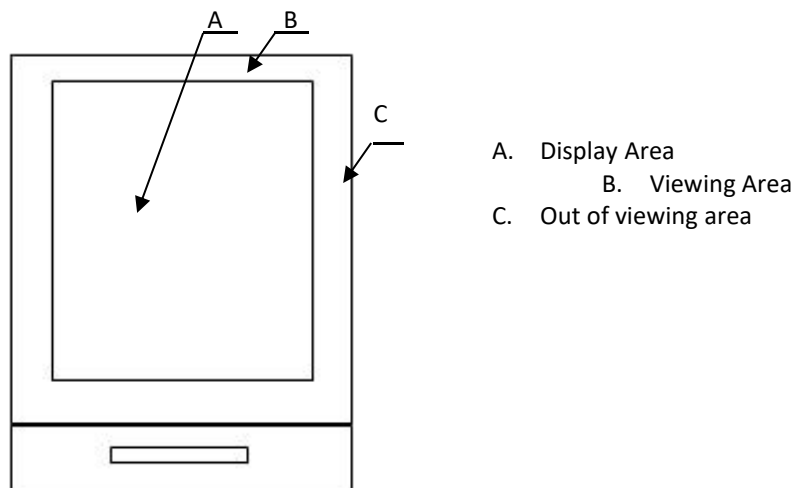

13.5. Basic principle:

- 13.5.1 According to IPC standards if standard is not described in specification.
- 13.5.2 A set ODNA and customer when there is any dispute happened.
- 13.5.3 New item must be added on time when it is necessary.

13.6. Inspection Specification:

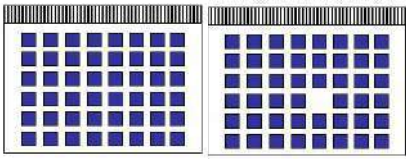
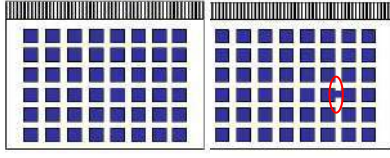
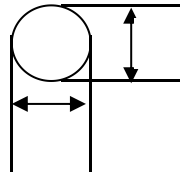
No.	Item	Criteria (Unit: mm)																													
<b>Functional</b>																															
01	LC leakage	LC leakage	Reject	Maj																											
02	Non-display	Non-display	Reject	Maj																											
03	Missing segment/ Missing character, dot or icon.		Reject	Maj																											
04	Exceeded dot/line/segment /Distortion		Reject	Maj																											
05	Dim Display	part of figures display dim than normal obviously	As the samples confirmed each other	Min																											
06	Wrong view angle	View angle is different from spec.	Reject	Maj																											
07	Not light	1.Backlight not work 2. Some LED not light	Reject	Maj																											
08	Backlight Luminance \\ uniformity	According to the product specification or limited samples	Reject	Min																											
09	Backlight Color	According to the product specification or limited samples	Reject	Min																											
10	CTP no response	CTP touch no response	Reject	Maj																											
11	Connection failure	FPC gold finger damage	Reject	Maj																											
<b>Cosmetic</b>																															
01	Black and white spot, Red, blue and green spot Dent Foreign material (Round type)	 $\phi = (a + b) / 2$ Distance between 2 defects should more than 10 mm apart.	<table border="1"> <thead> <tr> <th rowspan="2">Size(mm)</th> <th colspan="3">Area</th> </tr> <tr> <th>Zone A</th> <th>Zone B</th> <th>Zone C</th> </tr> </thead> <tbody> <tr> <td><math>\phi \leq 0.1</math></td> <td colspan="2">Ignore</td> <td>NC</td> </tr> <tr> <td><math>0.1 &lt; \phi \leq 0.15</math></td> <td colspan="2">3</td> <td>NC</td> </tr> <tr> <td><math>0.15 &lt; \phi \leq 0.2</math></td> <td colspan="2">2</td> <td>NC</td> </tr> <tr> <td><math>0.2 &lt; \phi \leq 0.25</math></td> <td colspan="2">1</td> <td>NC</td> </tr> <tr> <td><math>\phi &gt; 0.25</math></td> <td colspan="2">0</td> <td>NC</td> </tr> </tbody> </table>	Size(mm)	Area			Zone A	Zone B	Zone C	$\phi \leq 0.1$	Ignore		NC	$0.1 < \phi \leq 0.15$	3		NC	$0.15 < \phi \leq 0.2$	2		NC	$0.2 < \phi \leq 0.25$	1		NC	$\phi > 0.25$	0		NC	Min
Size(mm)	Area																														
	Zone A	Zone B	Zone C																												
$\phi \leq 0.1$	Ignore		NC																												
$0.1 < \phi \leq 0.15$	3		NC																												
$0.15 < \phi \leq 0.2$	2		NC																												
$0.2 < \phi \leq 0.25$	1		NC																												
$\phi > 0.25$	0		NC																												

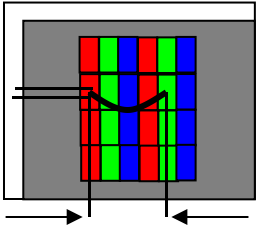

02	Black and White line Scratch Foreign material (Line type) (Min)				Min																												
		<table border="1" style="width: 100%; border-collapse: collapse;"> <thead> <tr> <th rowspan="2">Length (mm)</th> <th rowspan="2">Width (mm)</th> <th colspan="3">Acc. Qty</th> </tr> <tr> <th>Zone A</th> <th>Zone B</th> <th>Zone C</th> </tr> </thead> <tbody> <tr> <td><math>L \leq 5</math></td> <td><math>W \leq 0.02</math></td> <td colspan="2">Ignore</td> <td>NC</td> </tr> <tr> <td><math>L \leq 5</math></td> <td><math>0.02 &lt; W \leq 0.05</math></td> <td colspan="2">1</td> <td>NC</td> </tr> <tr> <td><math>L \leq 3</math></td> <td><math>0.05 &lt; W \leq 0.1</math></td> <td colspan="2">0</td> <td>NC</td> </tr> <tr> <td></td> <td><math>W &gt; 0.10</math></td> <td colspan="2">0</td> <td>NC</td> </tr> <tr> <td colspan="2" style="text-align: center;">Total</td> <td colspan="2">1</td> <td>NC</td> </tr> </tbody> </table> <p>Distance between 2 defects should more than 10mm apart.</p>	Length (mm)	Width (mm)		Acc. Qty			Zone A	Zone B	Zone C	$L \leq 5$	$W \leq 0.02$	Ignore		NC	$L \leq 5$	$0.02 < W \leq 0.05$	1		NC	$L \leq 3$	$0.05 < W \leq 0.1$	0		NC		$W > 0.10$	0		NC	Total	
Length (mm)	Width (mm)	Acc. Qty																															
		Zone A	Zone B	Zone C																													
$L \leq 5$	$W \leq 0.02$	Ignore		NC																													
$L \leq 5$	$0.02 < W \leq 0.05$	1		NC																													
$L \leq 3$	$0.05 < W \leq 0.1$	0		NC																													
	$W > 0.10$	0		NC																													
Total		1		NC																													
03	Polarizer concave and convex/bubbles	<table border="1" style="width: 100%; border-collapse: collapse;"> <thead> <tr> <th rowspan="2">Diameter: <math>\Phi</math>(mm)</th> <th colspan="3">Accept Qty</th> </tr> <tr> <th>Zone A</th> <th>Zone B</th> <th>ZoneC</th> </tr> </thead> <tbody> <tr> <td><math>\Phi &lt; 0.2\text{mm}</math></td> <td colspan="3">Ignore</td> </tr> <tr> <td><math>0.2\text{mm} &lt; \Phi \leq 0.5\text{mm}</math></td> <td>4</td> <td rowspan="2">Ignore</td> <td rowspan="2">Ignore</td> </tr> <tr> <td><math>0.5\text{mm} &lt; \Phi \leq 0.7\text{mm}</math></td> <td>2</td> </tr> <tr> <td><math>\Phi &gt; 0.7\text{mm}</math></td> <td colspan="3">Unacceptable</td> </tr> </tbody> </table>	Diameter: $\Phi$ (mm)	Accept Qty			Zone A	Zone B	ZoneC	$\Phi < 0.2\text{mm}$	Ignore			$0.2\text{mm} < \Phi \leq 0.5\text{mm}$	4	Ignore	Ignore	$0.5\text{mm} < \Phi \leq 0.7\text{mm}$	2	$\Phi > 0.7\text{mm}$	Unacceptable			Min									
		Diameter: $\Phi$ (mm)		Accept Qty																													
			Zone A	Zone B	ZoneC																												
		$\Phi < 0.2\text{mm}$	Ignore																														
		$0.2\text{mm} < \Phi \leq 0.5\text{mm}$	4	Ignore	Ignore																												
$0.5\text{mm} < \Phi \leq 0.7\text{mm}$	2																																
$\Phi > 0.7\text{mm}$	Unacceptable																																
Distance between 2 defects should more than 10mm apart.																																	
<p>*A dot is defined as a single sub-pixel (either red, green, or blue) within a pixel. Definition of Bright dots: Dots that can be seen through 6% ND filter.</p>			Allow																														
04	Bright/Dark dots, lines, Pixel defects	Bright dots	2	Min																													
		Adjacent bright dots	0																														
		Dark dots	4																														
		Adjacent dark dots	0																														
		Tiny bright dots	Judge by 6% ND filter, check with 30cm distance, if still can see, NG																														
		Mura(50% GERY)	Judge by 6% ND filter, check with 30cm distance, if still can see, NG																														
		Dark or Bright Lines	0																														
		Blank pixel/ Missing pixel	Not allow																														

Remark: One pixel consists of 3 sub-pixels, including R,G and B dot(Sub-pixel=Dot)

Note 1

Bright dot is defined through 6% transmission ND filter as following:

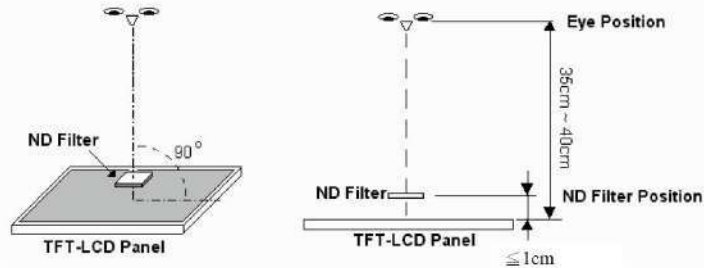

Defects on the black Matrix, out of viewing area, aren't considered as a defect counted.

Symbols

- X: Chip length
- Y: Chip width
- Z: Chip thickness
- K: Seal width
- T: Glass thickness
- A: LCD side length/LCD
- L: Electrode pad length

a) General glass chip

1. Chip on panel surface and crack between panels

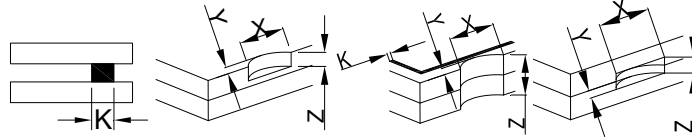

Z: Chip thickness	Y: Chip width	X: Chip length
$Z \leq 1/2T$	Not expanded in viewing area	$X \leq 1/8A$
$1/2T < Z \leq 2T$	Not exceed $1/3K$	$X \leq 3mm$

If there are 2 or more chips, X is the total length of each chip.

2. Corner crack:

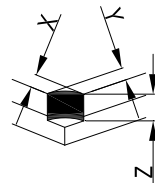

X, Y, Z Spec. same as a.1. If there are 2 or more chips, X is the total length of each chip.

b) Protrusion over terminal:

1. Chip on electrode pad

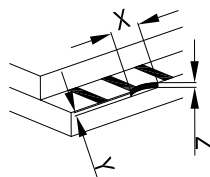

Y: Chip width	X: Chip length	Z: Chip thickness
$Y \leq 1/4 L$	$X \leq 3mm$	$0 < Z \leq T$

2. Non-conductive portion

05

TFT Glass cracked

Min

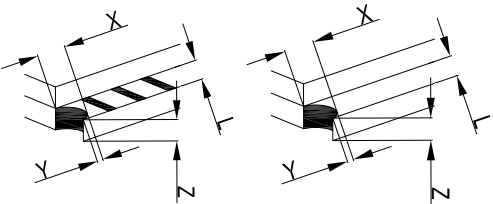
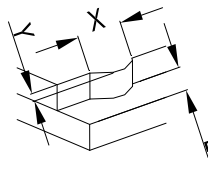
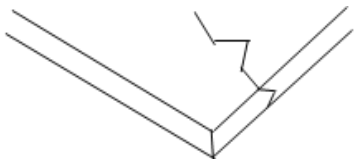
		 <table border="1" data-bbox="491 452 1193 555"> <tr> <td>Y: Chip width</td> <td>X: Chip length</td> <td>Z: Chip thickness</td> </tr> <tr> <td><math>Y \leq 1/3 L</math></td> <td><math>X \leq 3\text{mm}</math></td> <td><math>0 &lt; Z \leq T</math></td> </tr> </table> <p>If the chipped area reach the ITO terminal, over 2/3 of the ITO must be remained. If the product will be heat sealed by the customer, the alignment mark must not be damaged.</p> <p>3. Substrate protuberance and internal crack</p>  <table border="1" data-bbox="821 788 1149 880"> <tr> <td>Y: Width</td> <td>X: Length</td> </tr> <tr> <td><math>Y \leq 1/4 L</math></td> <td><math>X \leq A</math></td> </tr> </table> <p>c) LCD with extensive crack line is unacceptable.</p> 	Y: Chip width	X: Chip length	Z: Chip thickness	$Y \leq 1/3 L$	$X \leq 3\text{mm}$	$0 < Z \leq T$	Y: Width	X: Length	$Y \leq 1/4 L$	$X \leq A$	
Y: Chip width	X: Chip length	Z: Chip thickness											
$Y \leq 1/3 L$	$X \leq 3\text{mm}$	$0 < Z \leq T$											
Y: Width	X: Length												
$Y \leq 1/4 L$	$X \leq A$												
06	Discolor/rainbow	Discolor between the LCDs or in the same LCD	Refer to the limit samples signed by customers or ODNA	Min									
07	FPC/FFC /TAB/HSC	Connect surface oxidation	Not allow	Maj									
		Etching/damage /distortion	Not exceed 1/3 width of wire	Min									
		Connect surface contamination /foreign material	Width & length of electric foreign material could not exceed the width of 2 pins	Min									
		Connect surface scratch	The scratch depth not exceed 1/2 thickness of gold layer.	Min									
		Copper/protective film/base board film separate	Not allow	Maj									
		Others: FPC follow IPC-6013A standard.											
08	Soldering	Cold soldering, short soldering	Reject	Min									

		Not enough solder paste	Solder paste area < 75% solder pad area Solder paste area < 75% component solder point Solder paste height < 1/2 component height	Min
		FPC Pin deviation	Deviation area > 1/3 Solder pad	Min
		Others: Follow IPC-A-610E standard		
09	COG silicon coating	<ul style="list-style-type: none"> <li>a) Not exceed the surface of top polarizer, LCD left/right edges. Cover fully ITO, IC and the juncture of HSC/FPC and LCD.</li> <li>b) No visible non-metal foreign material and metal material in coating</li> <li>c) Entrapped air bubble isn't permissible to exist on the juncture of coating glue and pins of LCD.</li> <li>d) Bubbles or pinhole of silicon coating should <math>\Phi \leq 2\text{mm}</math></li> <li>e) The silicon should cover all around the IC and not gap in between silicon and side of IC, lack of coating on top of IC can be accepted</li> </ul>	Min	
11	Glass warping	Product diagonal length (mm)	Warpage range (mm)	Maj
		$L \leq 10$	0.05	
		$10 < L \leq 30$	0.1	
		$30 < L \leq 100$	0.2	
		$100 < L \leq 300$	0.4	
		$300 < L \leq 1000$	0.6	
		$1000 < L \leq 3000$	0.8	
14	Backlight	<ul style="list-style-type: none"> <li>1. Spots or scratches that appear when light must be judged using LCD glass spot, line and contamination standards.</li> <li>2. Brightness and Chromaticity can't be out of specification.</li> </ul>	Min	

### 13.7. RoHS Compliance

The product should RoHS Compliance.