

## MAX16191 Evaluation Kit

Evaluates: MAX16191

### General Description

The MAX16191 evaluation kit (EV kit) is a fully tested and assembled circuit that demonstrates the capabilities of the MAX16191, a single-channel, low-voltage window-detector supervisor circuit. The MAX16191 EV kit is designed to facilitate the evaluation of the MAX16191's 0.35% over-voltage/undervoltage (OV/UV) faults detection capability. A jumper, JP1, provides the option to connect the reset output's pullup resistor to a voltage other than  $V_{CC}$ . See MAX16191 IC data sheet for absolute maximum voltage ratings voltage on reset output. The MAX16191 EV kit is available in a 1" x 1" PCB and operates over the automotive temperature range of  $-40^{\circ}\text{C}$  to  $+125^{\circ}\text{C}$ .

### Features

- $\pm 0.35\%$  Threshold Accuracy
- 0.875V Nominal Threshold Range
- $\pm 3\%$  UV/OV Monitoring Range
- 10ms Reset Timeout for  $\overline{\text{RST}}$  signal
- Two Reset Output Pullup Voltage Options
- Proven 1" x 1" 2-Layer 2oz Copper PCB Layout
- Demonstrates Compact Solution Size
- Fully Assembled and Tested

*[Ordering Information](#) appears at end of data sheet.*

### MAX16191 EV Kit Files

FILE	DESCRIPTION
max16191_evkit_a_Schematic	EVKIT schematic
MAX16191_EVKIT_A_MARKETING_PCB	EVKIT PCB LAYOUT
build_bom_max16191_evkit_a	EVKIT Bill of Materials
max16191_evkit_a_odb	EVKIT ODB

### MAX16191 EV Kit Board Photo

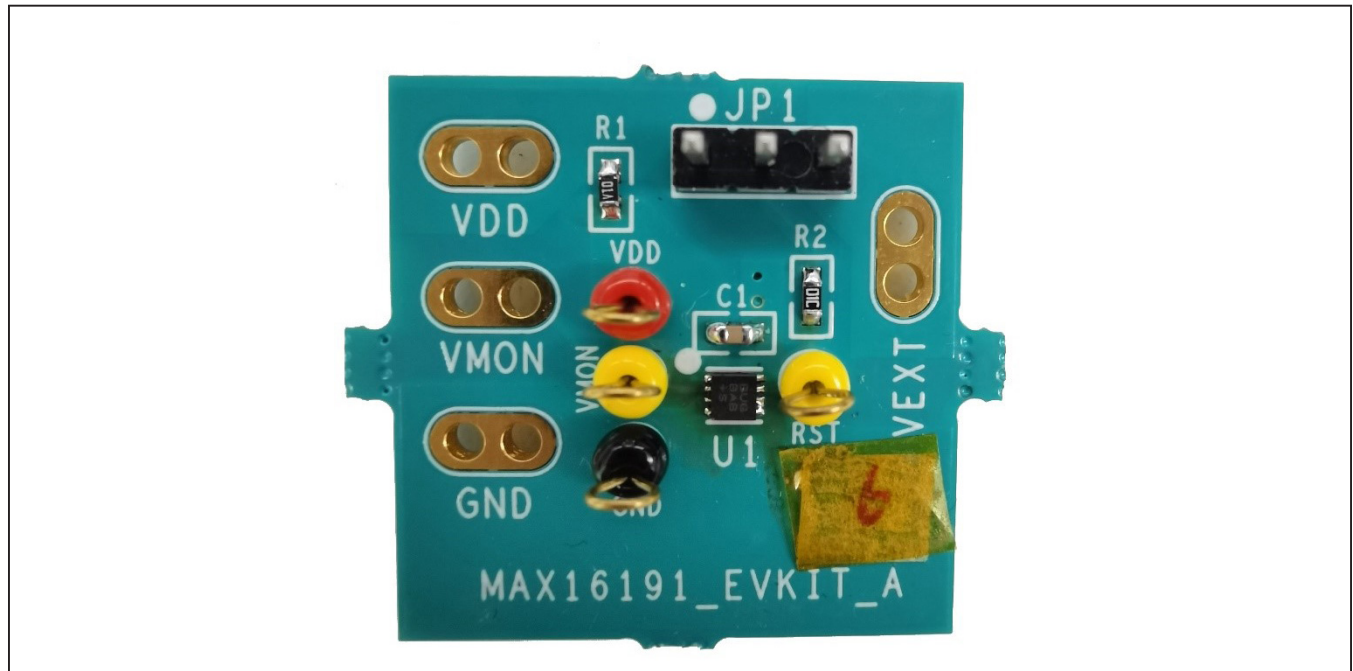

**Quick Start**

**Required Equipment**

- MAX16191 EV kit
- 5V/100mA DC power supply
- 1V/50mA high-precision DC power supply
- One digital multimeter (DMM)
- Function generator
- Two-channel oscilloscope

**Procedure**

The EV kit is fully assembled and tested. Follow the steps below to verify board operation.

**Caution: Do not turn on power supply until all connections are completed.**

- 1) Connect the positive terminal of the 5V/100mA power supply to VDD pad. Connect the ground terminal of the power supply to GND pad.
- 2) Connect the positive terminal of the 1V/50mA DC power supply to VMON pad. Connect the ground terminal of the power supply to GND pad.
- 3) Connect the positive terminal of the DMM to VMON\_TP test point and the negative terminal of the DMM to GND.
- 4) Ensure jumper (JP1) is in its default setting. See [Table 1](#) for more details.
- 5) Connect oscilloscope channel 1 to IN test point and channel 2 to RST test point.
- 6) Turn on the 5V/100mA power supply and slowly increase its output voltage to 5V.
- 7) Turn on the 1V/50mA DC power supply and slowly increase its output voltage to 0.875V.
- 8) Verify that the reading on the DMM is 0.875V.
- 9) Increase the 1V/50mA DC power supply voltage from 0.875V to 0.910V in approximately 1mV steps and verify that RST signal on the oscilloscope pulls low at around V<sub>OVTH</sub> value.

- 10) Decrease the 1V/50mA DC power supply voltage from 0.875V to 0.840V in approximately 1mV steps and verify that the RST signal on the oscilloscope pulls low at around V<sub>UVTH</sub> value.
- 11) The EV kit is ready for further testing.

**Calculating OV/UV Thresholds Voltage**

The MAX16191 monitors a system supply voltage for UV/OV window-threshold. Depending on the system supply tolerance requirement, the UV/OV thresholds can be factory-trimmed from ±2% to ±5%. The tolerance setting is symmetrical with respect to the selected nominal input threshold voltage. A detailed calculation of how to determine the UV/OV threshold levels with ±3% threshold accuracy is shown as follows:

$$V_{IN\_NOM} = 0.875V$$

$$TOL = \pm 3\%$$

$$V_{UVTH} = V_{IN\_NOM} (1 - 3\%) = 0.875V * (1 - 0.03) = 0.875V - 0.02625V = 0.84875V$$

$$V_{OVTH} = V_{IN\_NOM} (1 + 3\%) = 0.875V * (1 + 0.03) = 0.875V + 0.02625V = 0.90125V$$

Where V<sub>IN\_NOM</sub> is the selected nominal input threshold voltage,

TOL is the input tolerance

V<sub>UVTH</sub> is UV threshold voltage and

V<sub>OVTH</sub> is the OV threshold voltage

The MAX16191 monitors the supply voltage with ±0.35% accuracy over the operating temperature and supply range. The accuracy range for the 0.875V ±0.35% is shown below:

$$V_{UVTH\_A} = V_{IN\_NOM} (1 - 3\% \pm 0.35\%)$$

$$V_{OVTH\_A} = V_{IN\_NOM} (1 + 3\% \pm 0.35\%)$$

where V<sub>UVTH\_A</sub> is the UV threshold accuracy range and

V<sub>OVTH\_A</sub> is the OV threshold accuracy

**Table 1. Jumper, JP1, Settings**

JUMPER	SHUNT POSITION	DESCRIPTION
JP1	1-2*	RST is pulled up to VDD.
	2-3	RST is pulled up to VEXT.

\*Default Jumper Position

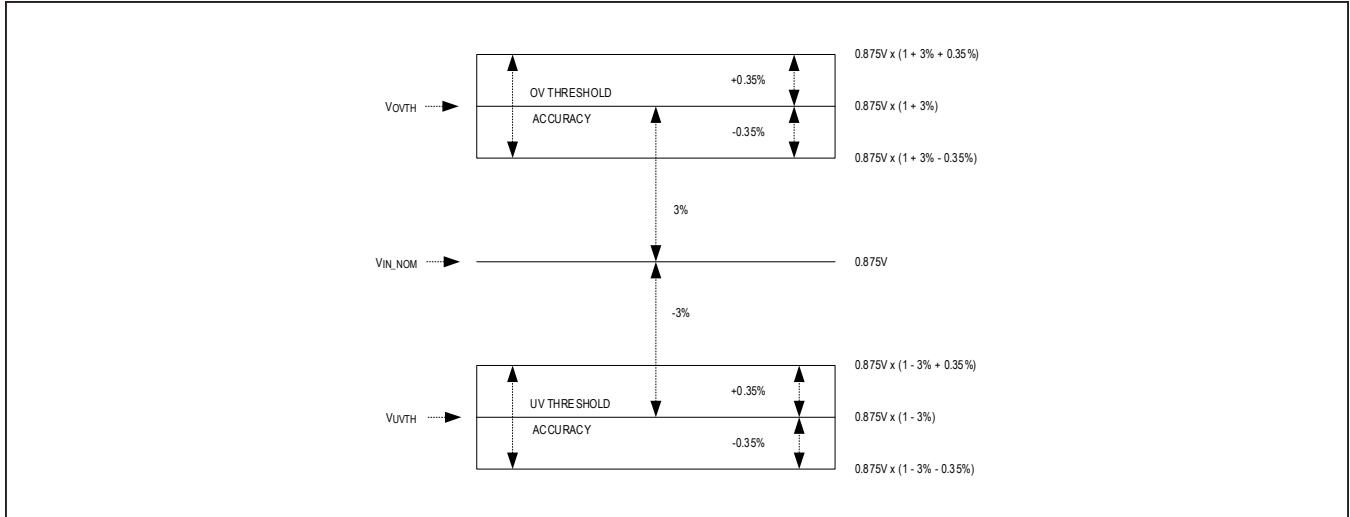

Figure 1. Undervoltage/Overvoltage Threshold Accuracy

### Component Suppliers

SUPPLIER	PHONE	WEBSITE
TDK	+81 3 67 78 10 00	www.tdk-electronics.tdk.com
KEYSTONE	(516) 328-7500	www.keyelco.com
WURTH ELECTRONICS INC	+1 877 6902207	www.we-ics.com
KEMET	+91-95131-45888	www.kemet.com/en/us.html
AVX	+1 (864) 967-2150	www.avx.com
LITE-ON ELECTRONICS INC.	0515-83368598	www.liteon.com/en-us
SAMTEC	1-800-726-8329	www.samtec.com
VISHAY	1-800-344-4539	www.vishay.com
PANASONIC	0571-87257895	www.panasonic.cn
BOURNS	+1 951-781-5500	www.bourns.com
YAGEO	+886 2 6629 9999	www.yageo.com/en/Home

**Note:** Indicate that you are using the MAX16191 when contacting these component suppliers.

### Ordering Information

PART	TYPE
MAX16191EVKIT#	EV Kit

#Denotes RoHS compliance.

MAX16191 EV Kit Bill of Materials

ITEM	QTY	REF DES	VAR STATUS	MAXINV	MFG PART #	MANUFACTURER	VALUE	DESCRIPTION	COMMENTS
1	1	C1	Pref	20-000U1-03	885012206071;C1608X7R1E104K080AA;C0603C104K3RAC;GRM188R71E104KA01;C1608X7R1E104K;06033C104KAT2A	WURTH ELECTRONICS INC;TDK;KEMET;MURATA;TDK;AVX	0.1UF	CAP; SMT (0603); 0.1UF; 10%; 25V; X7R; CERAMIC	
2	4	GND_TP, RST, VDD_TP, VMON_TP	Pref	EH111000004178	20-2137	VERO TECHNOLOGIES	N/A	TEST POINT; PIN DIA=1.65MM; TOTAL LENGTH=7.5MM; BOARD HOLE=1.02; BLACK; PHOSPHOR BRONZE WIRE; RECOMMENDED FOR BOARD THICKNESS=1.6MM ;NOTE:PURCHASE DIRECT FROM THE MANUFACTURER	
3	1	JP1	Pref	01-PEC03SAAN3P-21	PEC03SAAN	SULLINS	PEC03SAAN	CONNECTOR; MALE; THROUGH HOLE; BREAKAWAY; STRAIGHT; 3PINS	
4	1	R1	Pref	80-0100R-CA18	RNCP0603FTD100R	STACKPOLE ELECTRONICS INC	100	RES: SMT (0603); 100; 1%; +/-100PPM/DEGC; 0.1250W	
5	1	R2	Pref	80-0010K-53	CRCW060310K0JN;ERJ-3GEYJ103	VISHAY DALE;PANASONIC	10K	RES: SMT (0603); 10K; 5%; +/-200PPM/DEGK; 0.1000W	
6	1	SU1	Pref	02-JMPFS1100B-00	S1100-B;SX1100-B;STC02SYAN	KYCON;KYCON;SULLINS ELECTRONICS CORP.	SX1100-B	TEST POINT; JUMPER; STR; TOTAL LENGTH=0.24IN; BLACK; INSULATION=PBT;PHOSPHOR BRONZE CONTACT=GOLD PLATED	
7	1	U1	Pref	00-SAMPLE-01	MAX16191ATA00/VY+	MAXIM	MAX16191ATA00/VY+	EVKIT PART - IC; 0.3%; ACCURACY SUPERVISORY CIRCUIT; PACKAGE OUTLINE: 21-100341; PACKAGE LAND PATTERN: 90-100117; PACKAGE CODE: T822CY-2; TDFN8	
8	1	PCB	-	EPCB16191	MAX16191	MAXIM	PCB	PCB:MAX16191	-
<b>TOTAL</b>	<b>11</b>								

DO NOT PURCHASE(DNP)									
ITEM	QTY	REF DES	VAR STATUS	MAXINV	MFG PART #	MANUFACTURER	VALUE	DESCRIPTION	COMMENTS
<b>TOTAL</b>	<b>0</b>								

PACKOUT (These are purchased parts but not assembled on PCB and will be shipped with PCB)									
ITEM	QTY	REF DES	VAR STATUS	MAXINV	MFG PART #	MANUFACTURER	VALUE	DESCRIPTION	COMMENTS
<b>TOTAL</b>	<b>0</b>								

MAX16191 EV Kit Schematic Diagram

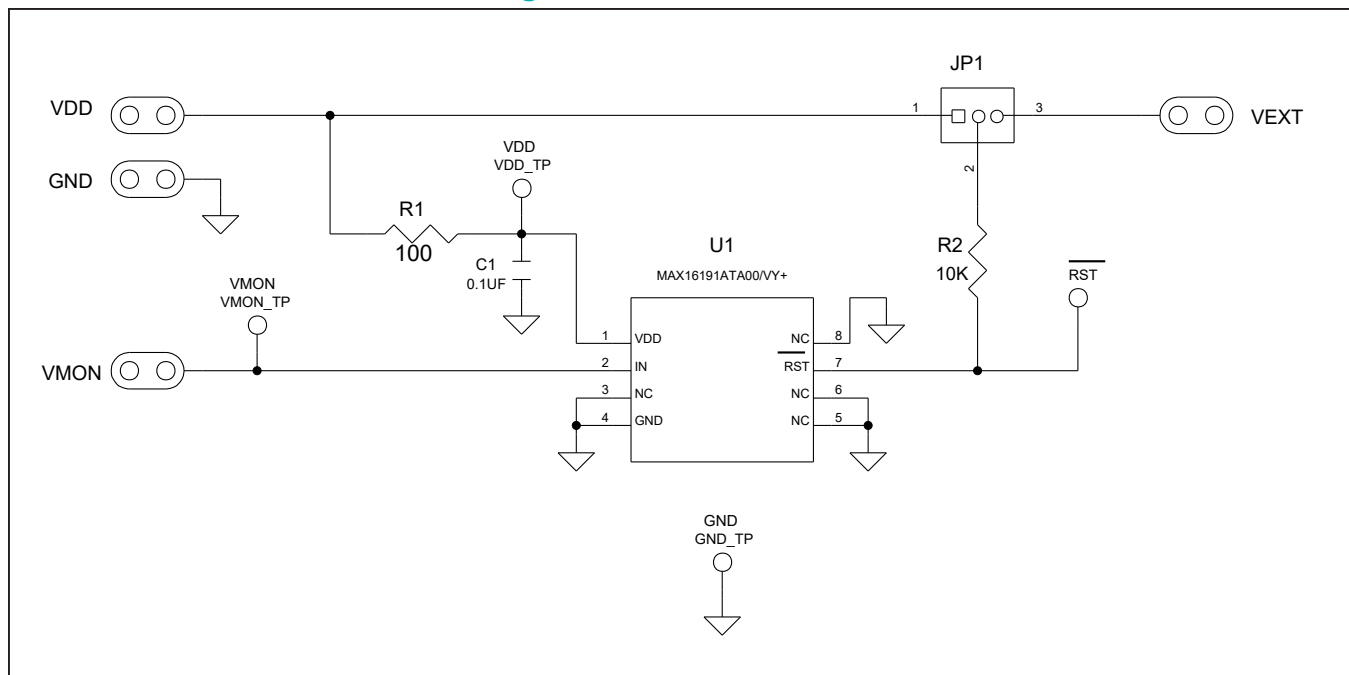

MAX16191 EV Kit PCB Layouts

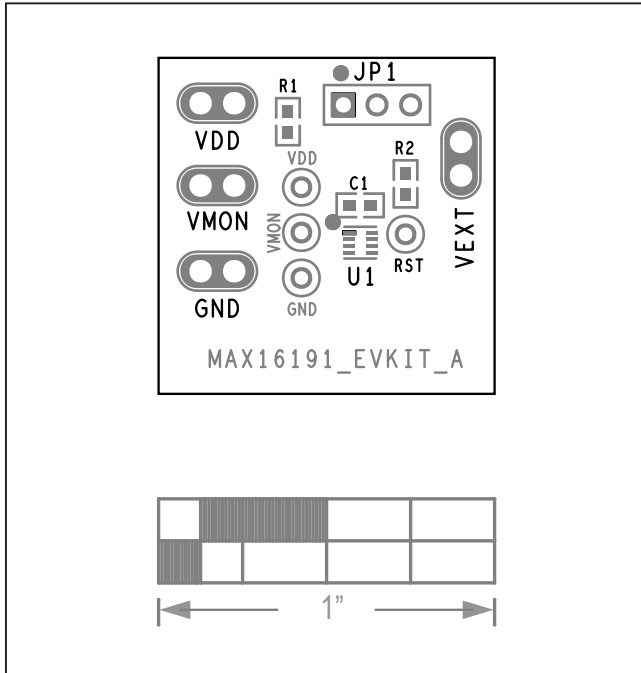

MAX16191 EV Kit PCB Layout--Silk Top

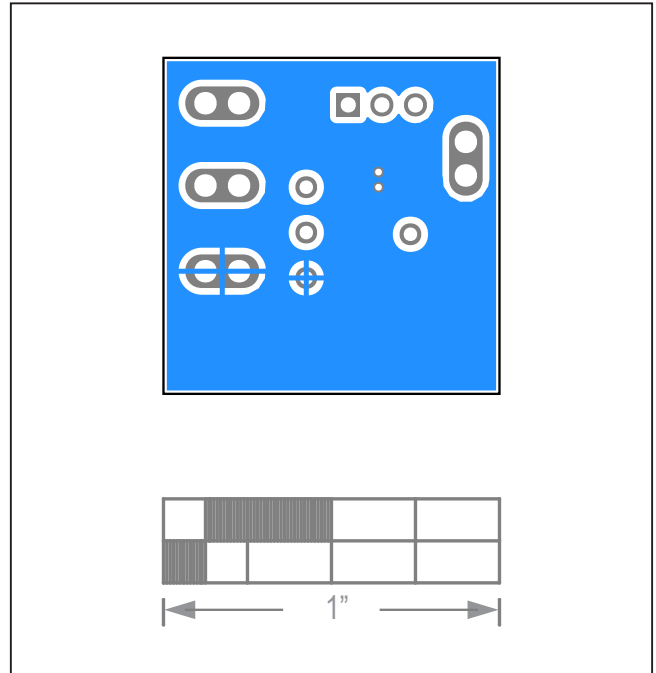

MAX16191 EV Kit PCB layout--Bottom

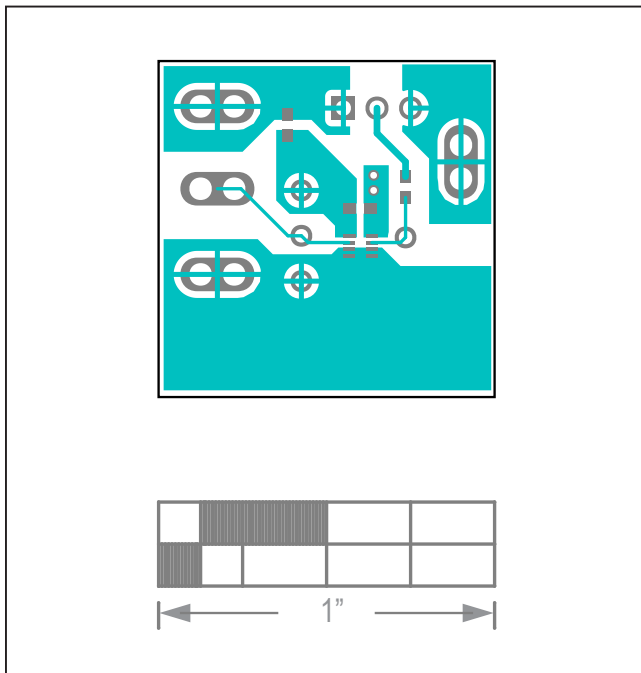

MAX16191 EV Kit PCB Layout--Top

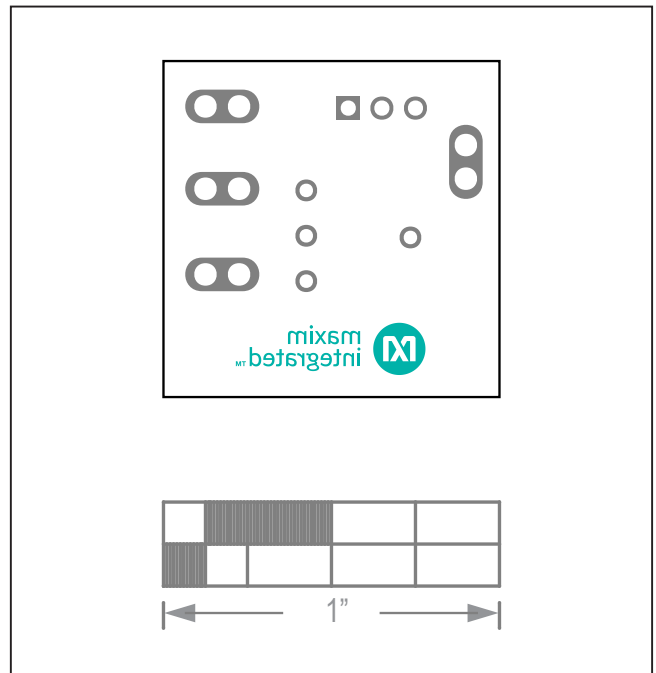

MAX16191 EV Kit PCB Layout--Silk Bottom

## Revision History

REVISION NUMBER	REVISION DATE	DESCRIPTION	PAGES CHANGED
0	7/21	Initial release	—

For pricing, delivery, and ordering information, please visit Maxim Integrated's online storefront at <https://www.maximintegrated.com/en/storefront/storefront.html>.

*Maxim Integrated cannot assume responsibility for use of any circuitry other than circuitry entirely embodied in a Maxim Integrated product. No circuit patent licenses are implied. Maxim Integrated reserves the right to change the circuitry and specifications without notice at any time.*