

MOSFET – N-Channel, POWERTRENCH[®], SyncFET™

30 V, 18 A, 9.3 mΩ

FDMC7692S

General Description

This FDMC7692S is produced using onsemi’s advanced POWERTRENCH process that has been especially tailored to minimize the on-state resistance. This device is well suited for Power Management and load switching applications common in Notebook Computers and Portable Battery Packs.

Features

- Max $r_{DS(on)}$ = 9.3 mΩ at $V_{GS} = 10\text{ V}$, $I_D = 12.5\text{ A}$
- Max $r_{DS(on)}$ = 13.6 mΩ at $V_{GS} = 4.5\text{ V}$, $I_D = 10.4\text{ A}$
- High Performance Technology for Extremely Low $r_{DS(on)}$
- These Devices are Pb-Free and are RoHS Compliant

Applications

- DC – DC Buck Converters
- Notebook DC – DC Application

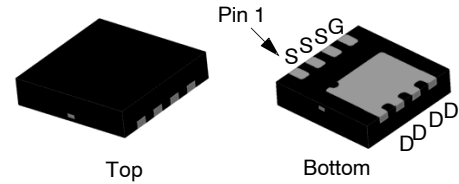

Top Bottom
 WDFN8 3.3x3.3, 0.65P
 CASE 511DQ (Option A)

MARKING DIAGRAM

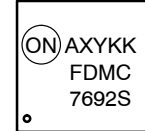

FDMC7692S = Specific Device Code
 A = Assembly Location
 XY = 2-Digit Date Code
 KK = 2-Digit Lot Run Traceability Code

PIN ASSIGNMENT

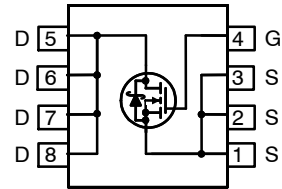

ORDERING INFORMATION

See detailed ordering and shipping information on page 6 of this data sheet.

FDMC7692S

MOSFET MAXIMUM RATINGS ($T_A = 25^\circ\text{C}$ unless otherwise noted)

Symbol	Parameter	Rating	Unit			
V_{DS}	Drain to Source Voltage	30	V			
V_{GS}	Gate to Source Voltage	± 20	V			
I_D	Drain Current	Continuous	$T_C = 25^\circ\text{C}$	18	A	
		Continuous (Note 1a)	$T_A = 25^\circ\text{C}$			12.5
		Pulsed				45
E_{AS}	Single Pulse Avalanche Energy (Note 2)	21	mJ			
P_D	Power Dissipation	$T_C = 25^\circ\text{C}$	27	W		
	Power Dissipation (Note 1a)	$T_A = 25^\circ\text{C}$	2.3			
T_J, T_{STG}	Operating and Storage Junction Temperature Range	-55 to 150	$^\circ\text{C}$			

Stresses exceeding those listed in the Maximum Ratings table may damage the device. If any of these limits are exceeded, device functionality should not be assumed, damage may occur and reliability may be affected.

THERMAL CHARACTERISTICS

Symbol	Parameter	Rating	Unit
$R_{\theta JC}$	Thermal Resistance, Junction to Case	4.7	$^\circ\text{C}/\text{W}$
$R_{\theta JA}$	Thermal Resistance, Junction to Ambient (Note 1a)	53	

1. $R_{\theta JA}$ is determined with the device mounted on a 1 in² pad 2 oz copper pad on a 1.5 x 1.5 in. board of FR-4 material. $R_{\theta JC}$ is guaranteed by design while $R_{\theta CA}$ is determined by the user's board design.

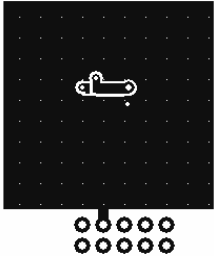

- a. $53^\circ\text{C}/\text{W}$ when mounted on a 1 in² pad of 2 oz copper

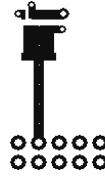

- b. $125^\circ\text{C}/\text{W}$ when mounted on a minimum pad of 2 oz copper

2. E_{AS} of 21 mJ is based on starting $T_J = 25^\circ\text{C}$; $L = 0.3$ mH, $I_{AS} = 12.0$ A, $V_{DD} = 27$ V, $V_{GS} = 10$ V. 100% test at $L = 3$ mH, $I_{AS} = 3.2$ A.

FDMC7692S

ELECTRICAL CHARACTERISTICS (T_J = 25°C unless otherwise noted)

Symbol	Parameter	Test Conditions	Min	Typ	Max	Unit
--------	-----------	-----------------	-----	-----	-----	------

OFF CHARACTERISTICS

BV _{DSS}	Drain to Source Breakdown Voltage	I _D = 1 mA, V _{GS} = 0 V	30	–	–	V
ΔBV _{DSS} / ΔT _J	Breakdown Voltage Temperature Coefficient	I _D = 10 mA, referenced to 25°C	–	16	–	mV/°C
I _{DSS}	Zero Gate Voltage Drain Current	V _{DS} = 24 V, V _{GS} = 0 V	–	–	500	μA
I _{GSS}	Gate to Source Leakage Current	V _{GS} = 20 V, V _{DS} = 0 V	–	–	100	nA

ON CHARACTERISTICS (Note 3)

V _{GS(th)}	Gate to Source Threshold Voltage	V _{GS} = V _{DS} , I _D = 1 mA	1.2	2.0	3.0	V
ΔV _{GS(th)} / ΔT _J	Gate to Source Threshold Voltage Temperature Coefficient	I _D = 10 mA, referenced to 25°C	–	–5	–	mV/°C
r _{DS(on)}	Static Drain to Source On Resistance	V _{GS} = 10 V, I _D = 12.5 A	–	7.8	9.3	mΩ
		V _{GS} = 4.5 V, I _D = 10.4 A	–	10.8	13.6	
		V _{GS} = 10 V, I _D = 12.5 A, T _J = 125°C	–	9.6	13.0	
g _{FS}	Forward Transconductance	V _{DS} = 5 V, I _D = 12.5 A	–	62	–	S

DYNAMIC CHARACTERISTICS

C _{iss}	Input Capacitance	V _{DS} = 15 V, V _{GS} = 0 V, f = 1 MHz	–	1040	1385	pF
C _{oss}	Output Capacitance		–	445	590	pF
C _{rss}	Reverse Transfer Capacitance		–	40	60	pF
R _g	Gate Resistance	f = 1 MHz	–	1.1	2.9	Ω

SWITCHING CHARACTERISTICS

t _{d(on)}	Turn-On Delay Time	V _{DD} = 15 V, I _D = 12.5 A, V _{GS} = 10 V, R _{GEN} = 6 Ω	–	9	17	ns
t _r	Rise Time		–	3	10	ns
t _{d(off)}	Turn-Off Delay Time		–	19	34	ns
t _f	Fall Time		–	3	10	ns
Q _g	Total Gate Charge	V _{GS} = 0 V to 10 V, V _{DD} = 15 V, I _D = 12.5 A	–	16	23	nC
		V _{GS} = 0 V to 4.5 V, V _{DD} = 15 V, I _D = 12.5 A	–	8	10	nC
Q _{gs}	Total Gate Charge	V _{DD} = 15 V, I _D = 12.5 A	–	4	–	nC
Q _{gd}	Gate to Drain "Miller" Charge		–	2	–	nC

DRAIN-SOURCE DIODE CHARACTERISTICS

V _{SD}	Source to Drain Diode Forward Voltage	V _{GS} = 0 V, I _S = 12.5 A (Note 3)	–	0.9	1.3	V
		V _{GS} = 0 V, I _S = 0.9 A (Note 3)	–	0.5	0.7	
t _{rr}	Reverse Recovery Time	I _F = 12.5 A, di/dt = 300 A/μs	–	21	33	ns
Q _{rr}	Reverse Recovery Charge		–	16	29	nC

Product parametric performance is indicated in the Electrical Characteristics for the listed test conditions, unless otherwise noted. Product performance may not be indicated by the Electrical Characteristics if operated under different conditions.

3. Pulse Test: Pulse Width < 300 μs, Duty cycle < 2.0%.

TYPICAL CHARACTERISTICS ($T_J = 25^\circ\text{C}$ unless otherwise noted)

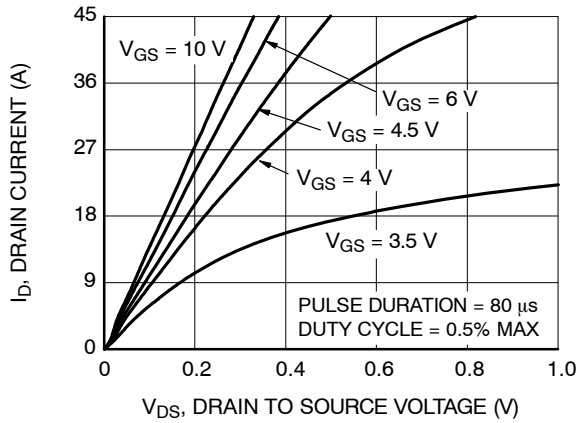

Figure 1. On Region Characteristics

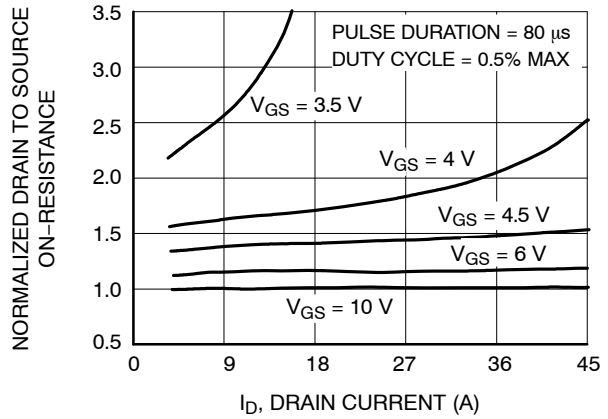

Figure 2. Normalized On-Resistance vs. Drain Current and Gate Voltage

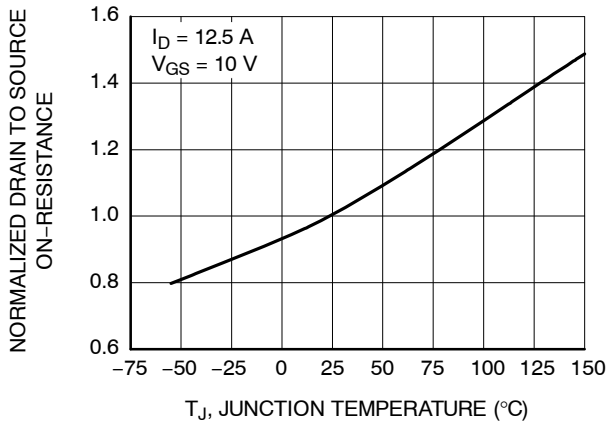

Figure 3. Normalized On Resistance vs. Junction Temperature

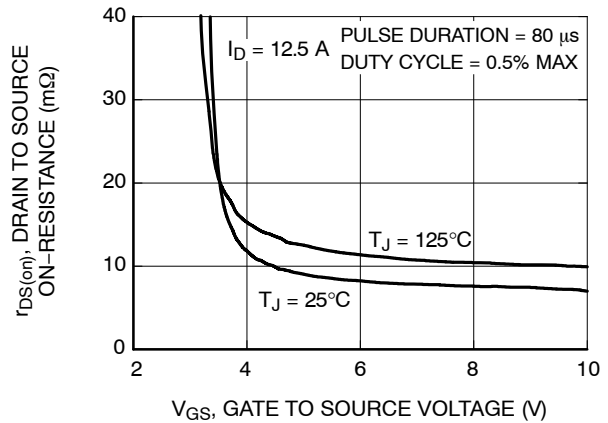

Figure 4. On-Resistance vs. Gate to Source Voltage

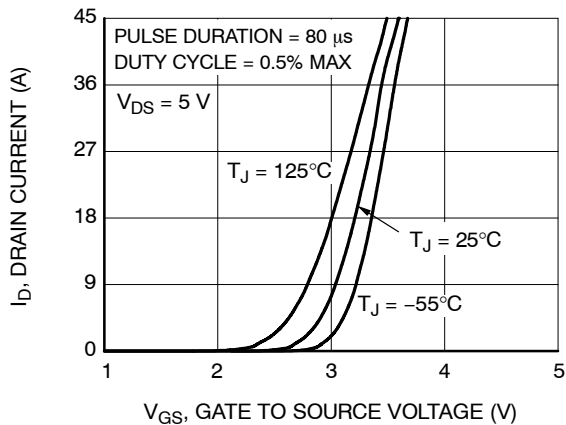

Figure 5. Transfer Characteristics

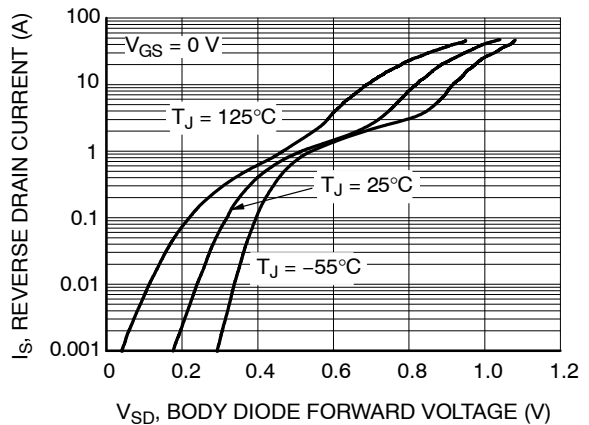

Figure 6. Source to Drain Diode Forward Voltage vs. Source Current

TYPICAL CHARACTERISTICS ($T_J = 25^\circ\text{C}$ unless otherwise noted) (continued)

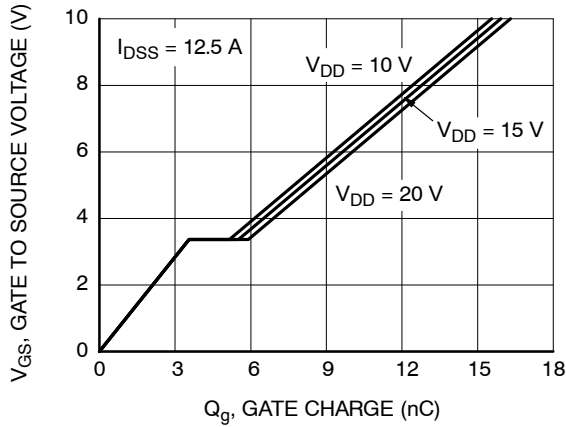

Figure 7. Gate Charge Characteristics

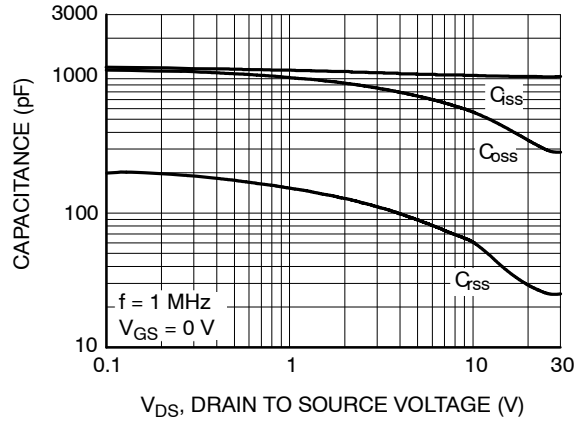

Figure 8. Capacitance vs. Drain to Source Voltage

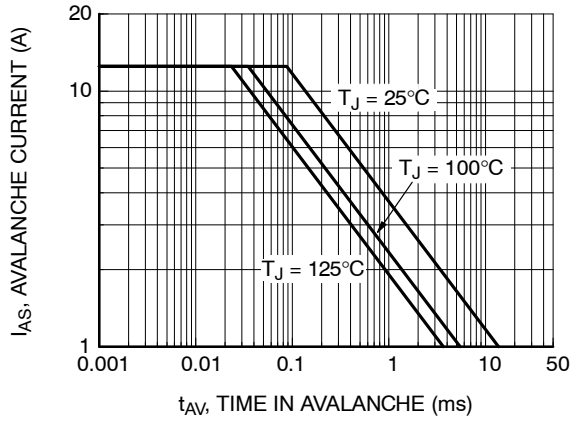

Figure 9. Unclamped Inductive Switching Capability

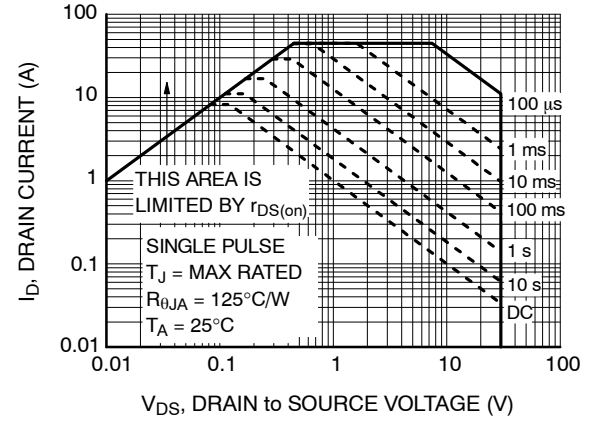

Figure 10. Forward Bias Safe Operating Area

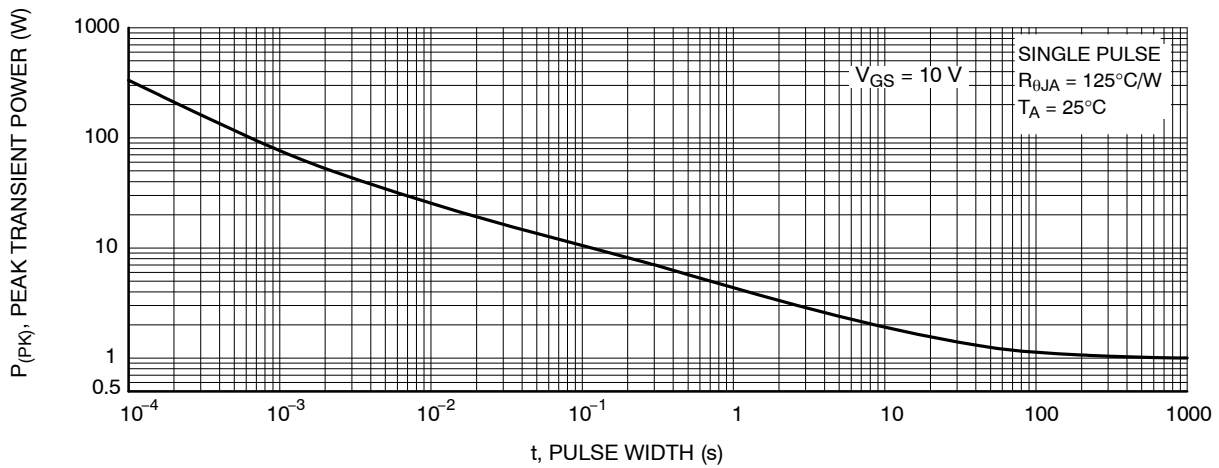

Figure 11. Single Pulse Maximum Power Dissipation

FDMC7692S

TYPICAL CHARACTERISTICS ($T_J = 25^\circ\text{C}$ unless otherwise noted) (continued)

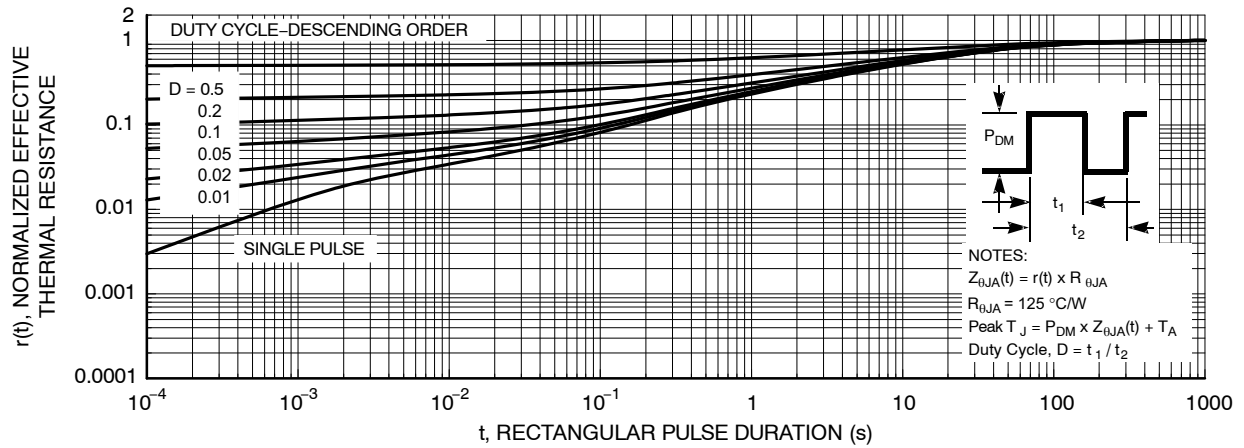

Figure 12. Junction-to-Ambient Transient Thermal Response Curve

ORDERING INFORMATION

Device	Device Marking	Package Type	Shipping [†]
FDMC7692S	FDMC7692S	WDFN8 3.3x3.3, 0.65P case 511DQ (Pb-Free)	3000 / Tape & Reel

[†]For information on tape and reel specifications, including part orientation and tape sizes, please refer to our Tape and Reel Packaging Specifications Brochure, BRD8011/D.

POWERTRENCH is a registered trademark of Semiconductor Components Industries, LLC dba “onsemi” or its affiliates and/or subsidiaries in the United States and/or other countries.

SyncFET is a trademark of Semiconductor Components Industries, LLC dba “onsemi” or its affiliates and/or subsidiaries in the United States and/or other countries.

MECHANICAL CASE OUTLINE

PACKAGE DIMENSIONS

ON Semiconductor®



WDFN8 3.3x3.3, 0.65P

CASE 511DQ

ISSUE O

DATE 31 OCT 2016

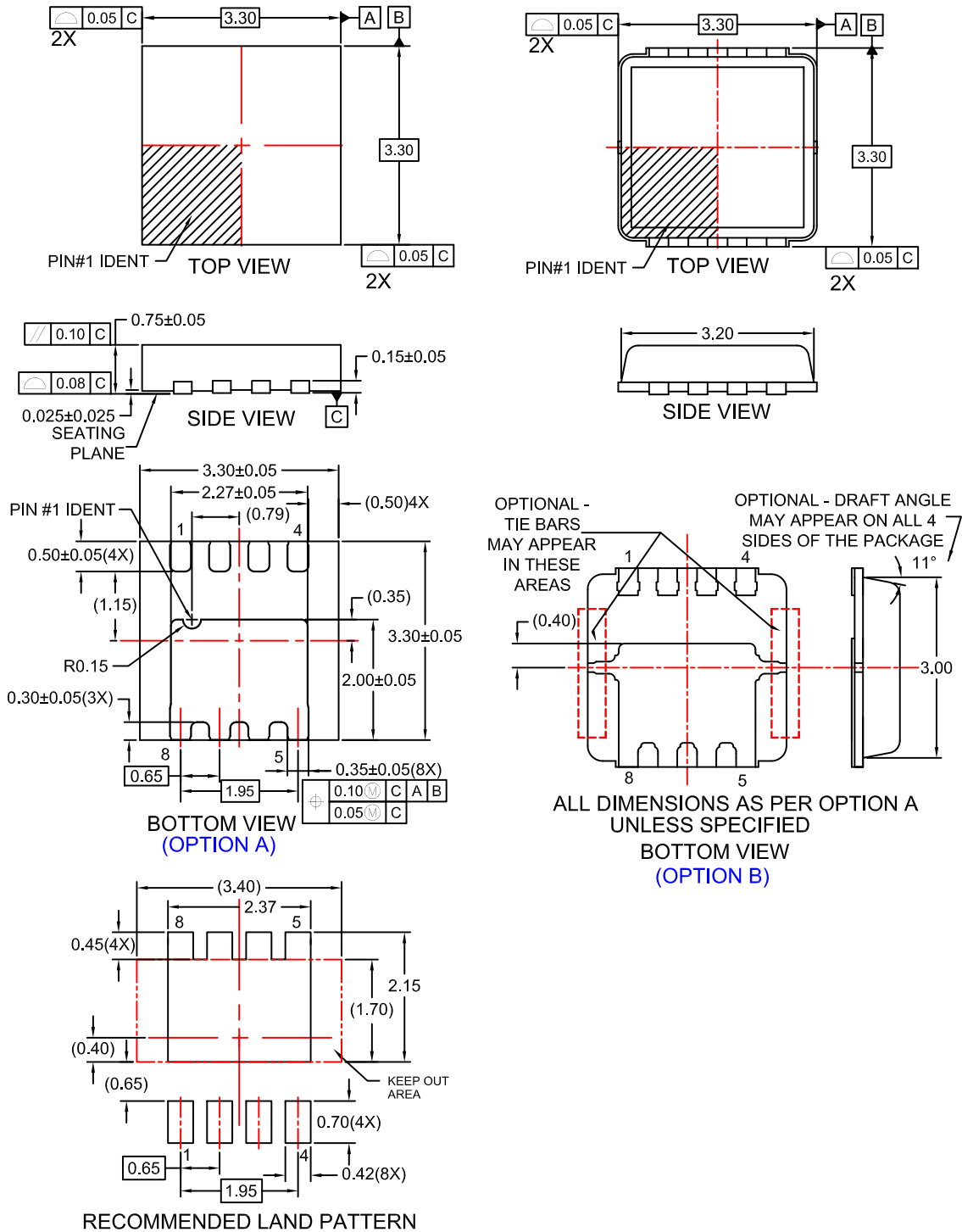

DOCUMENT NUMBER:	98AON13648G	Electronic versions are uncontrolled except when accessed directly from the Document Repository. Printed versions are uncontrolled except when stamped "CONTROLLED COPY" in red.
DESCRIPTION:	WDFN8 3.3X3.3, 0.65P	PAGE 1 OF 2

ON Semiconductor and are trademarks of Semiconductor Components Industries, LLC dba ON Semiconductor or its subsidiaries in the United States and/or other countries. ON Semiconductor reserves the right to make changes without further notice to any products herein. ON Semiconductor makes no warranty, representation or guarantee regarding the suitability of its products for any particular purpose, nor does ON Semiconductor assume any liability arising out of the application or use of any product or circuit, and specifically disclaims any and all liability, including without limitation special, consequential or incidental damages. ON Semiconductor does not convey any license under its patent rights nor the rights of others.

WDFN8 3.3x3.3, 0.65P
CASE 511DQ
ISSUE O

DATE 31 OCT 2016

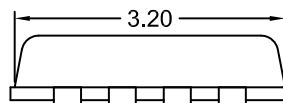
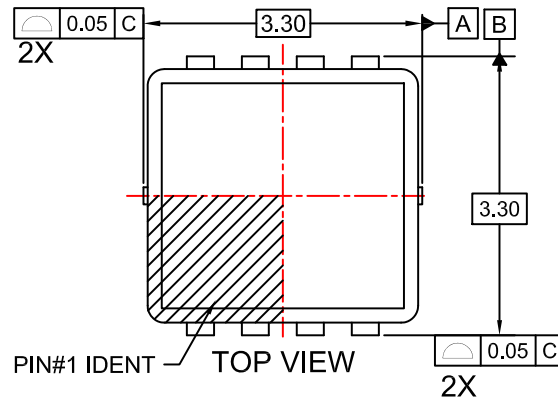

SIDE VIEW

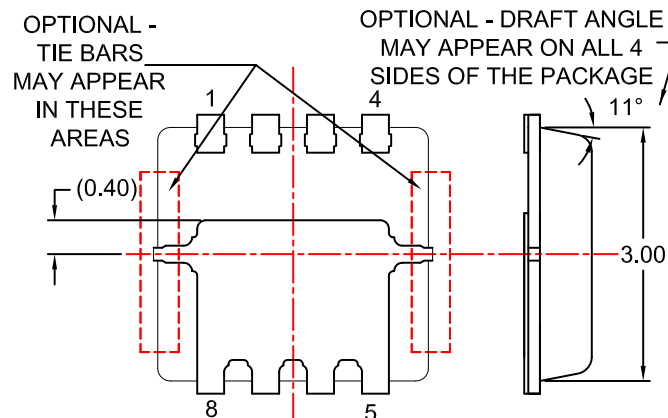

ALL DIMENSIONS AS PER OPTION A
UNLESS SPECIFIED

BOTTOM VIEW
(OPTION C)

NOTES:

- A. PACKAGE DOES NOT FULLY CONFORM TO JEDEC REGISTRATION MO-240.
- B. DIMENSIONS ARE IN MILLIMETERS.
- C. DIMENSIONS AND TOLERANCES PER ASME Y14.5M, 2009.
- D. LAND PATTERN RECOMMENDATION IS EXISTING INDUSTRY LAND PATTERN
- E. DIMENSIONS DO NOT INCLUDE BURRS OR MOLD FLASH. BURRS OR MOLD FLASH SHALL NOT EXCEED 0.10MM.

DOCUMENT NUMBER:	98AON13648G	Electronic versions are uncontrolled except when accessed directly from the Document Repository. Printed versions are uncontrolled except when stamped "CONTROLLED COPY" in red.
DESCRIPTION:	WDFN8 3.3X3.3, 0.65P	PAGE 2 OF 2

ON Semiconductor and are trademarks of Semiconductor Components Industries, LLC dba ON Semiconductor or its subsidiaries in the United States and/or other countries. ON Semiconductor reserves the right to make changes without further notice to any products herein. ON Semiconductor makes no warranty, representation or guarantee regarding the suitability of its products for any particular purpose, nor does ON Semiconductor assume any liability arising out of the application or use of any product or circuit, and specifically disclaims any and all liability, including without limitation special, consequential or incidental damages. ON Semiconductor does not convey any license under its patent rights nor the rights of others.

onsemi, **Onsemi**, and other names, marks, and brands are registered and/or common law trademarks of Semiconductor Components Industries, LLC dba "**onsemi**" or its affiliates and/or subsidiaries in the United States and/or other countries. **onsemi** owns the rights to a number of patents, trademarks, copyrights, trade secrets, and other intellectual property. A listing of **onsemi**'s product/patent coverage may be accessed at www.onsemi.com/site/pdf/Patent-Marking.pdf. **onsemi** reserves the right to make changes at any time to any products or information herein, without notice. The information herein is provided "as-is" and **onsemi** makes no warranty, representation or guarantee regarding the accuracy of the information, product features, availability, functionality, or suitability of its products for any particular purpose, nor does **onsemi** assume any liability arising out of the application or use of any product or circuit, and specifically disclaims any and all liability, including without limitation special, consequential or incidental damages. Buyer is responsible for its products and applications using **onsemi** products, including compliance with all laws, regulations and safety requirements or standards, regardless of any support or applications information provided by **onsemi**. "Typical" parameters which may be provided in **onsemi** data sheets and/or specifications can and do vary in different applications and actual performance may vary over time. All operating parameters, including "Typicals" must be validated for each customer application by customer's technical experts. **onsemi** does not convey any license under any of its intellectual property rights nor the rights of others. **onsemi** products are not designed, intended, or authorized for use as a critical component in life support systems or any FDA Class 3 medical devices or medical devices with a same or similar classification in a foreign jurisdiction or any devices intended for implantation in the human body. Should Buyer purchase or use **onsemi** products for any such unintended or unauthorized application, Buyer shall indemnify and hold **onsemi** and its officers, employees, subsidiaries, affiliates, and distributors harmless against all claims, costs, damages, and expenses, and reasonable attorney fees arising out of, directly or indirectly, any claim of personal injury or death associated with such unintended or unauthorized use, even if such claim alleges that **onsemi** was negligent regarding the design or manufacture of the part. **onsemi** is an Equal Opportunity/Affirmative Action Employer. This literature is subject to all applicable copyright laws and is not for resale in any manner.

PUBLICATION ORDERING INFORMATION

LITERATURE FULFILLMENT:

Email Requests to: orderlit@onsemi.com

onsemi Website: www.onsemi.com

TECHNICAL SUPPORT

North American Technical Support:

Voice Mail: 1 800-282-9855 Toll Free USA/Canada

Phone: 011 421 33 790 2910

Europe, Middle East and Africa Technical Support:

Phone: 00421 33 790 2910

For additional information, please contact your local Sales Representative