



# **ORIENT DISPLAY**

Your Total LCD Solution Provider

## Specification for OLED

### **AOM12864A0-0.96WW-ANO**

Revision O



AO	Orient Display Passive Matrix OLED
M	Monochrome
12864	Resolution 128 x 64
A0	Revision A0
0.96	Diagonal: 0.96", Module: 27.3 x 27.8 x 5.0 mm
W	White Character
W	Top: -40~+70°C; Tstr: -40~+85°C
ANO	4-line SPI/Compatible Arduino
/	All Viewing Angle
/	Controller <a href="#">SSD1306</a> / <a href="#">SSD1315</a> Or Compatible



DOCUMENT REVISION HISTORY:

DATE	PAGE	DESCRIPTION
2020.11.3	-	First release

# **Contents**

1. General Specification
2. Mechanical Drawing
3. Block Diagram
4. Interface Pin Function
5. Absolute Maximum Ratings
6. Electrical Characteristics
7. Optical Characteristics
8. Timing Characteristics
9. Standard Specification for Reliability
10. General Precautions
11. Specification of Quality Assurance
12. Packing Method

# 1. General Specification

Item	Dimension	Unit
Module dimension	27.3 x 27.8 x 5.0(MAX)	mm
View area	23.7 x 12.9	mm
Active area	21.74 x 10.86	mm
Dot size	0.154 x 0.154	mm
Dot pitch	0.17 x 0.17	mm
Number of Dots	128 x 64	dots
Top Polarizer Type	Anti-Glare	
View direction	All View	
Drive IC	SSD1306/SSD1315	
Interface Type	SPI 4-wires	
Display Colour	White, Blue, Yellow-Blue available	
Touch Panel	Not Available	

## 2. Mechanical Drawing

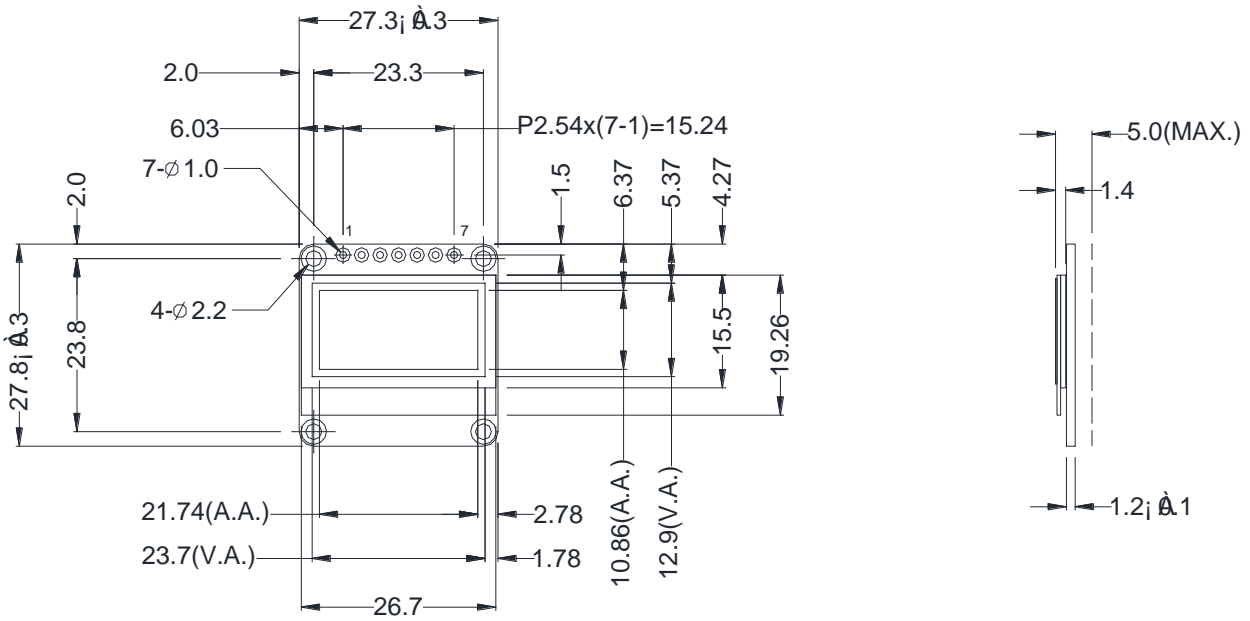

\*SSD1306/SSD1315 or equivalent  
White, Blue, Yellow & Blue available

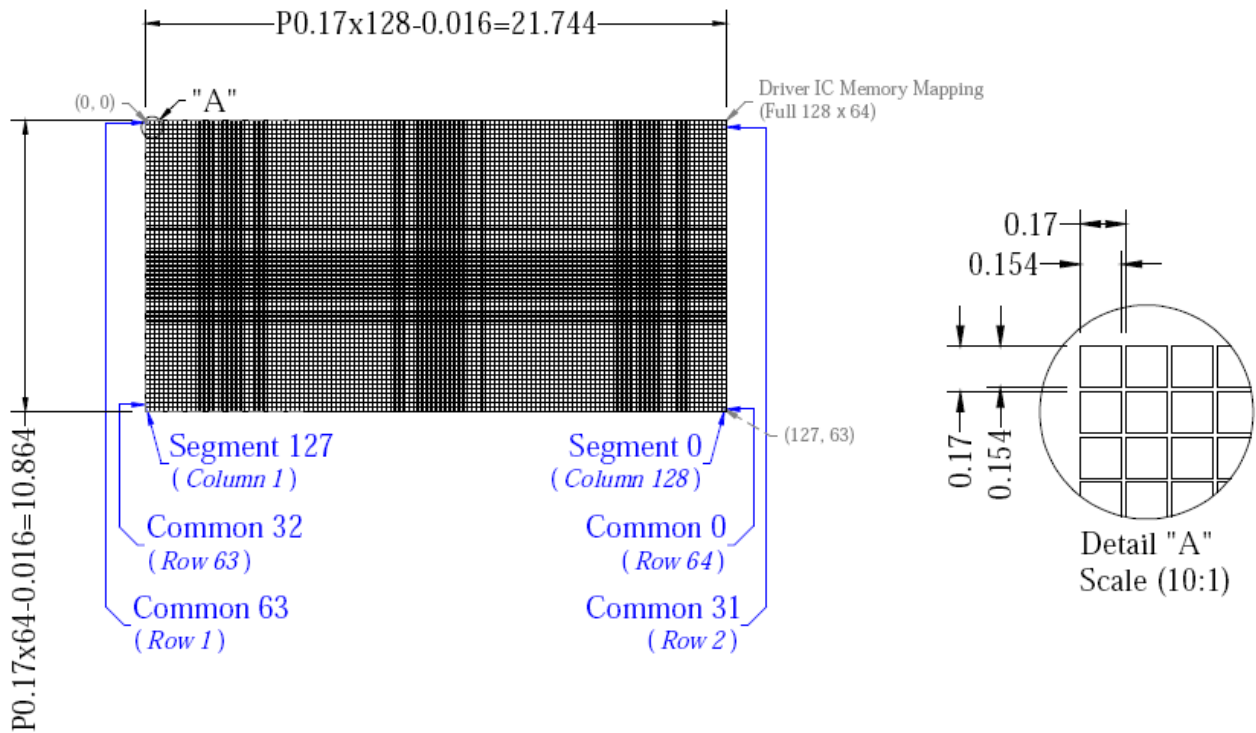

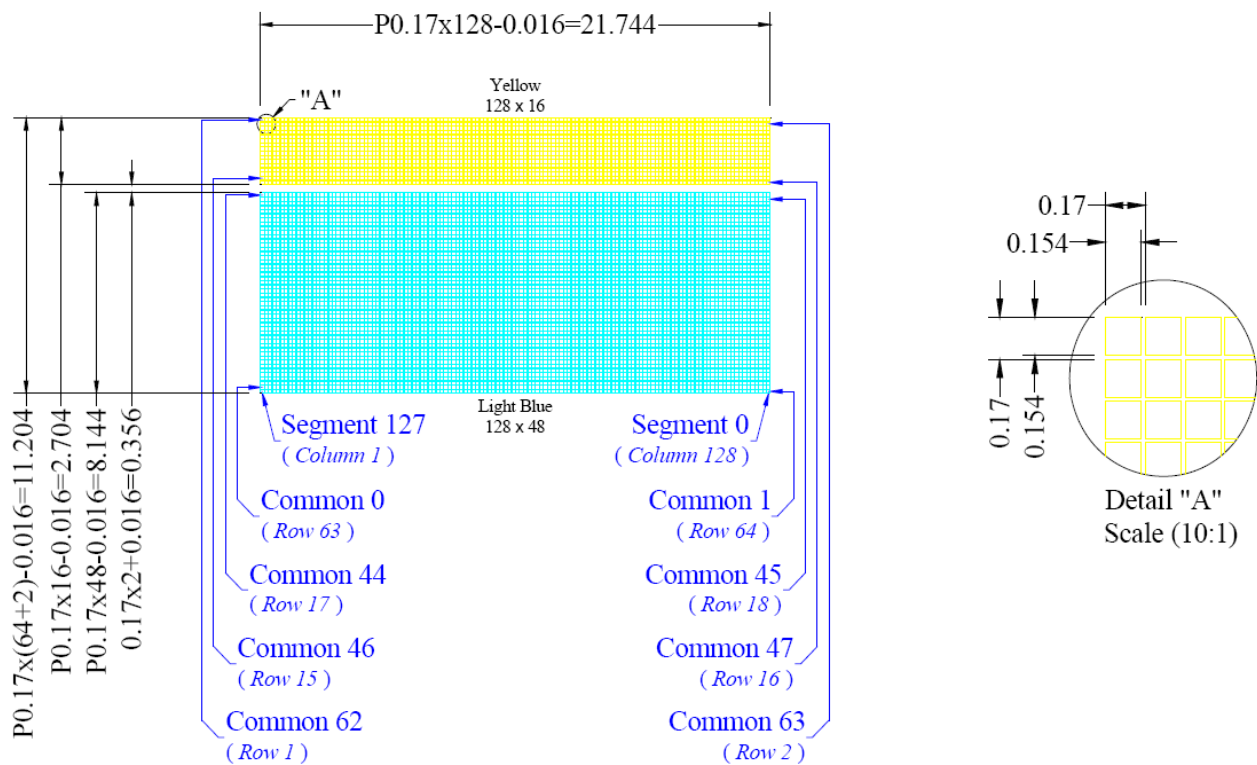

### 3. Block Diagram

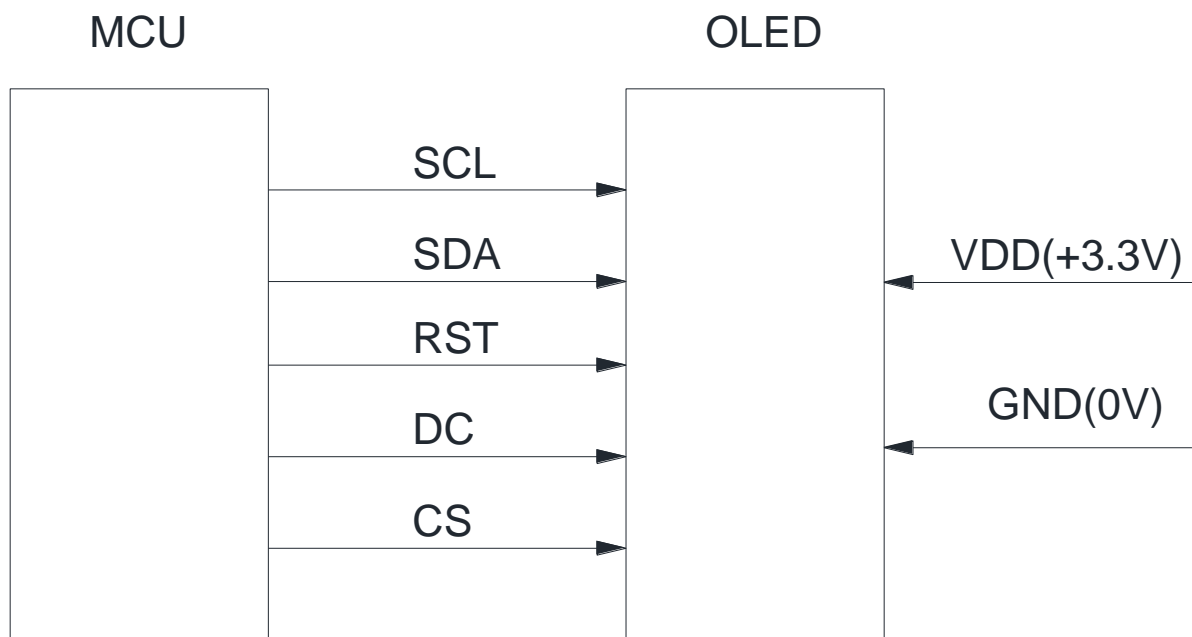

## 4. Interface Pin Function

Pin No.	Symbol	Level	Description
1	GND	0V	Ground
2	V <sub>DD</sub>	3.3V	Supply Voltage for logic
3	SCL	H/L	Serial Clock
4	SDA	H/L	Serial Data
5	RST	H/L	Reset, signal is active low
6	DC	H/L	H:Display data or Parameter, L:Command Data
7	CS	H/L	Chip Select, signal is active low

## 5. Absolute Maximum Ratings

Item	Symbol	Min	Max	Unit
Supply Voltage	V <sub>DD</sub>	-0.3	4.0	V
Input Voltage(logic input)	V <sub>In</sub>	-0.3	V <sub>DD</sub> +0.3	V
Operating Temperature	Top	-40	70	°C
Storage Temperature	Tstr	-40	85	°C
Life Time (120 Cd/m <sup>2</sup> )		10,000	-	Hours
Life Time (80 Cd/m <sup>2</sup> )		30,000	-	Hours
Life Time (60 Cd/m <sup>2</sup> )		50,000	-	Hours

Note: The absolute maximum rating values of this product are not allowed to be exceeded at any time. Should a module be used with any of the absolute maximum ratings exceeded, the characteristics of the module may not be recovered, or in an extreme case, the module may be permanently destroyed.

The defined temperature ranges do not include the polarizer. The maximum withstood temperature of the polarizer should be 80°C

End of lifetime is specified as 50% of initial brightness reached. The average operating lifetime at room temperature is estimated by the accelerated operation at high temperature conditions.

## 6. Electrical Characteristics

Item	Symbol	Condition	Min	Typ	Max	Unit
Supply Voltage	$V_{DD}$	—	2.7	3.0	3.3	V
Input Voltage for Logic	$V_{io}$	-	0	-	3.3	V
Input High Volt.	$V_{IH}$	—	$0.8V_{DD}$	—	$V_{DD}$	V
Input Low Volt.	$V_{IL}$	—	$V_{SS}$	—	$0.2V_{DD}$	V

## 7. Optical Characteristics

Item	Symbol	Condition	Min	Typ	Max	Unit
Luminance	L	—	60	—	—	Cd/m <sup>2</sup>
Contrast Ratio	CR	$\theta=0^\circ$	—	2000:1	—	—
C.I.E. (White)	(x)	C.I.E. 1931	0.24	0.27	0.33	
	(y)		0.25	0.30	0.35	
C.I.E. (Blue)	(x)	C.I.E. 1931	0.12	0.16	0.20	
	(y)		0.22	0.26	0.30	
C.I.E. (Yellow)	(x)	C.I.E. 1931	0.44	0.50	0.54	
	(y)		0.45	0.49	0.54	
Viewing Angle			—	Free	—	Degree

\* Optical measurement taken at  $V_{DD} = 2.8V$ , VCC Generated by Internal DC/DC.

## 8. Timing Characteristics



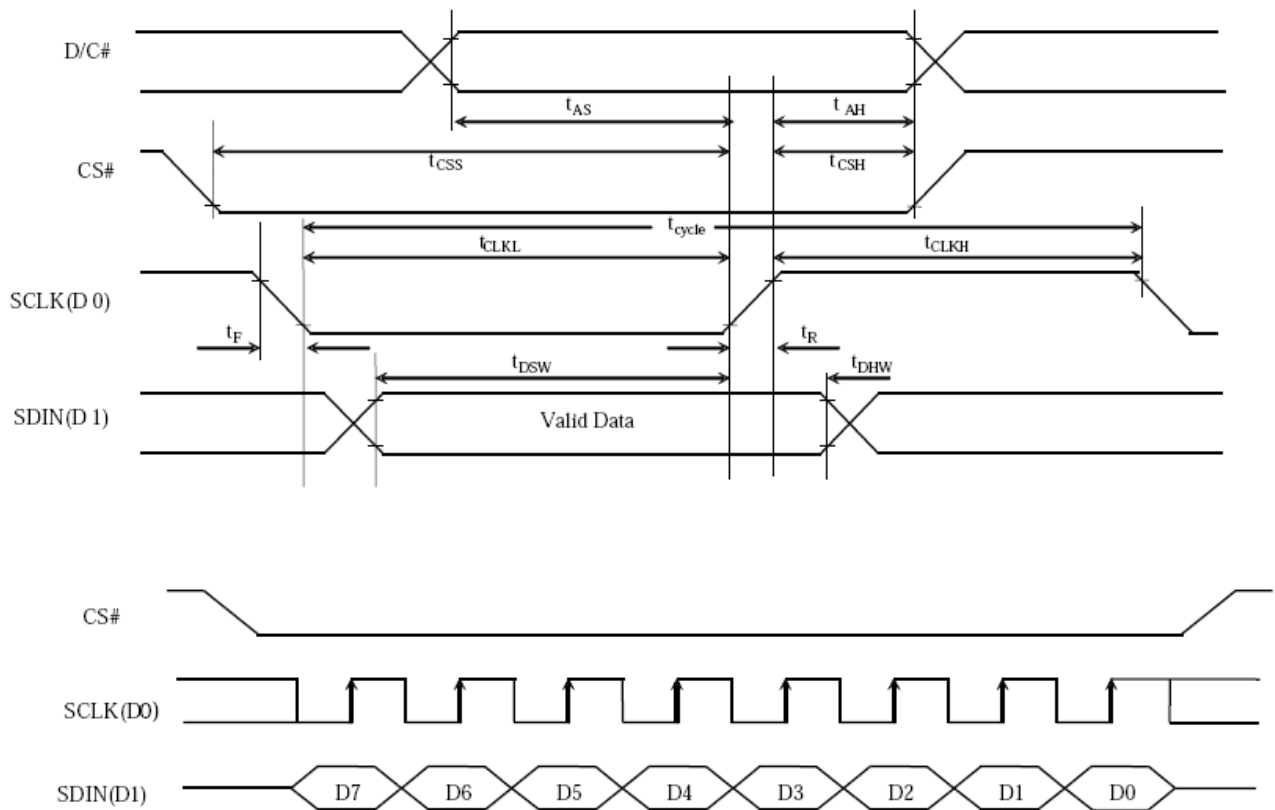

(VDD - VSS = 1.65V to 3.3V, TA = 25°C)

Symbol	Parameter	Min	Typ	Max	Unit
$t_{cycle}$	Clock Cycle Time	100	-	-	ns
$t_{AS}$	Address Setup Time	15	-	-	ns
$t_{AH}$	Address Hold Time	15	-	-	ns
$t_{CSS}$	Chip Select Setup Time	20	-	-	ns
$t_{CSH}$	Chip Select Hold Time	10	-	-	ns
$t_{DSW}$	Write Data Setup Time	15	-	-	ns
$t_{DHW}$	Write Data Hold Time	15	-	-	ns
$t_{CLKL}$	Clock Low Time	20	-	-	ns
$t_{CLKH}$	Clock High Time	20	-	-	ns
$t_R$	Rise Time	-	-	40	ns
$t_F$	Fall Time	-	-	40	ns

## 9. Standard Specification for Reliability

## Reference Test condition

No	Test Item	Condition	Remarks
1	High Temperature Operation	T <sub>s</sub> = +70°C, 96 hours	IEC60068-21:2007 GB2423.2-2008
2	Low Temperature Operation	T <sub>s</sub> = -40°C, 96 hours	IEC60068-2-1:2007 GB/2423.1-2008
3	High Temperature Storage	T <sub>a</sub> = +85°C, 96 hours	IEC60068-21:2007 GB/2423.2-2008
4	Low Temperature Storage	T <sub>a</sub> = -40°C, 96 hours	IEC60068-21:2007 GB/2423.1-2008
5	Storage at High Temperature and Humidity	T <sub>a</sub> = +60°C, 90% RH max,48 hours	IEC60068-2-78 :2001 GB/T2423.3—2006
6	Thermal Shock (nonoperation)	-40°C 30 min~+85°C 30 min, Change time:5min, 10 Cycle	Start with cold temperature, End with high temperature, IEC60068-214:1984, GB/2423.22-2002
7	Vibration Test	Frequency range:10~55Hz Stroke:1.5mm Sweep:10Hz~55Hz~10Hz 2 hours for each direction of X.Y.Z (6 hours for total)	IEC60068-2-6:1982 GB/T2423.101995
8	Mechanical Shock (Non Op)	Half Sine Wave60G 6ms, ± X, ± Y, ± Z 3times for each direction	IEC60068-2-27:1987 GB/T2423.5—1995
9	Package Drop Test	Height:80cm, 1 corner,3 edges,6 surfaces	IEC60068-2-32:1990 GB/T2423.8—1995

Note1: T<sub>s</sub> is the temperature of panel's surface.

Note2: T<sub>a</sub> is the ambient temperature of sample.

## 10.Specification of Quality Assurance

This standard of Quality Assurance confirms to the quality of OLED module

products supplied by ODNA.

## 10.1 Environment Required

Customer's test & measurement are required to be conducted under the following conditions:

Temperature:  $23 \pm 5^\circ\text{C}$

Humidity:  $55 \pm 15\%$  RH

Fluorescent Lamp: 30W

Distance between the Panel & Lamp:  $\geq 50\text{cm}$

Distance between the Panel & Eyes of the Inspector:  $\geq 30\text{cm}$

Finger glove (or finger cover) must be worn by the inspector.

Inspection table or jig must be anti-electrostatic.

## 10.2 Sampling Plan



Level II, Normal Inspection, Single Sampling, MIL-STD-105E.

## 10.3 Criteria & Acceptable Quality Level

Partition	AQL	Definition
Major	0.65	Defects in Pattern Check (Display On)
Minor	1	Defects in Cosmetic Check (Display Off)

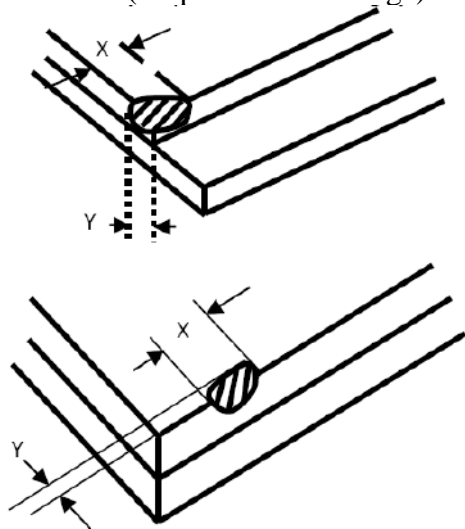
### 10.3.1 Cosmetic Check (Display Off) in Non-Active Area

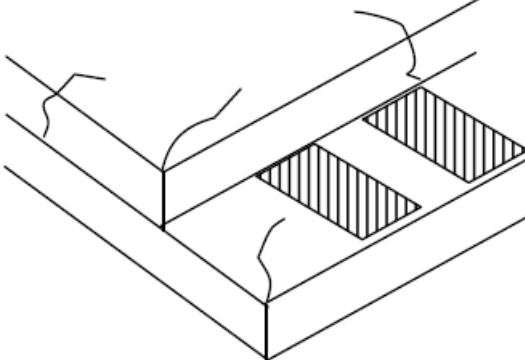
Check Item	Classification	Criteria
Panel General Chipping	Minor	$X > 6\text{ mm}$ (Along with Edge) $Y > 1\text{ mm}$ (Perpendicular to edge) 
Check Item	Classification	Criteria
Panel Crack	Minor	Any crack is not allowable.

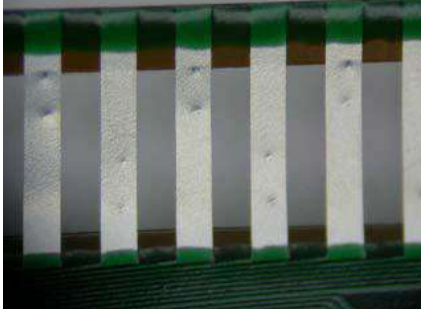
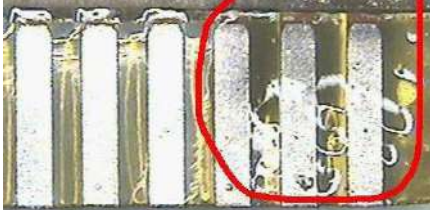
		
Copper Exposed (Even Pin or Film)	Minor	Not Allowable by Naked Eye Inspection
Film or Trace Damage	Minor	
Terminal Lead Prober Mark	Acceptable	
Glue or Contamination on Pin (Couldn't Be Removed by Alcohol)	Minor	
Ink Marking on Back Side of panel (Exclude on Film)	Acceptable	Ignore for Any
Panel Crack	1	Defects in Cosmetic Check (Display Off)

### 10.3.2 Cosmetic Check (Display Off) in Active Area

It is recommended to execute in clear room environment (class 10k) if actual in necessary.

Check Item	Classification	Criteria
Any Dirt & Scratch on Polarizer's Protective Film	Acceptable	Ignore for not Affect the Polarizer
Scratches, Fiber, Line-Shape Defect (On Polarizer)	Minor	$W \leq 0.1$ Ignore $W > 0.1$ $L \leq 2$ $n \leq 1$ $L > 2$ $n = 0$
Dirt, Black Spot, Foreign Material, (On Polarizer)	Minor	$\Phi \leq 0.1$ Ignore $0.10 < \Phi \leq 0.25$ $n \leq 1$ $0.25 < \Phi$ $n = 0$
Dent, Bubbles, White spot (Any Transparent Spot on Polarizer)	Minor	$\Phi \leq 0.5$ Ignore if no Influence on Display $0.5 < \Phi$ $n = 0$
Fingerprint, Flow Mark (On Polarizer)	Minor	Not Allowable

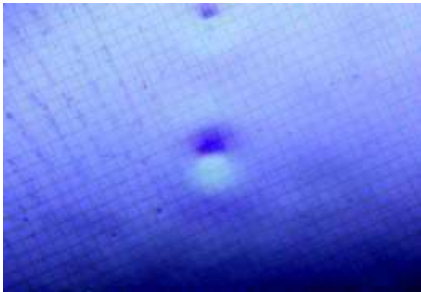

\* Protective film should not be tear off when cosmetic check.

\*\* Definition of W & L & T (Unit: mm):  $T = (a + b) / 2$

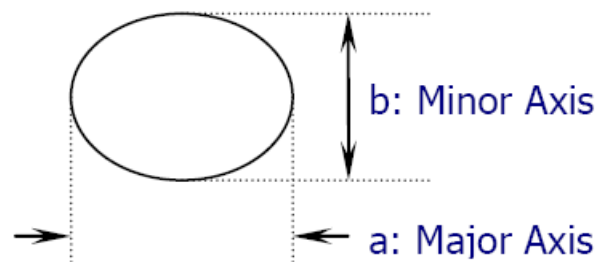
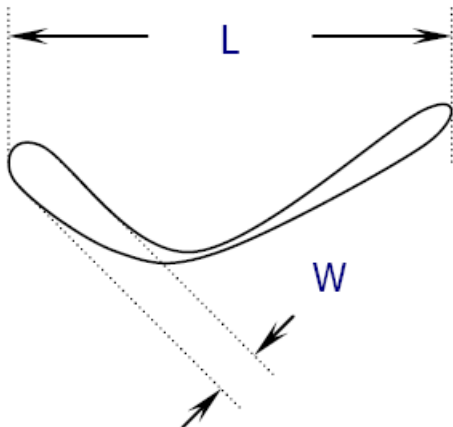

### 10.3.2 Pattern Check (Display On) in Active Area

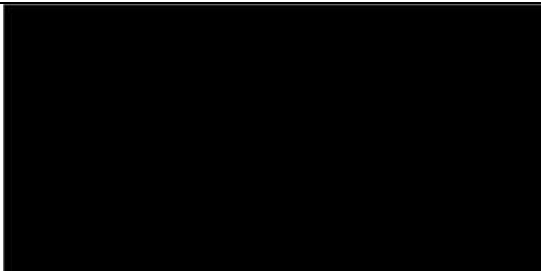
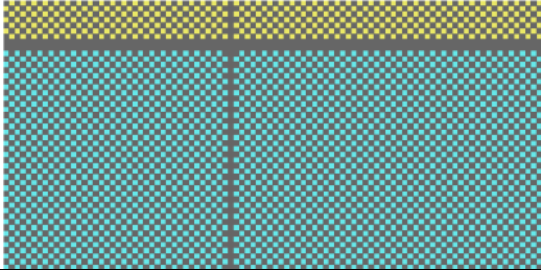
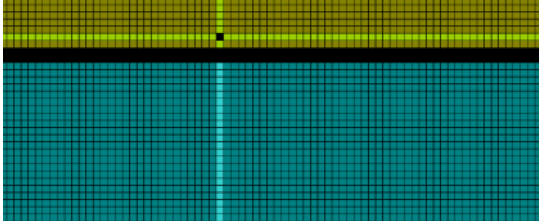
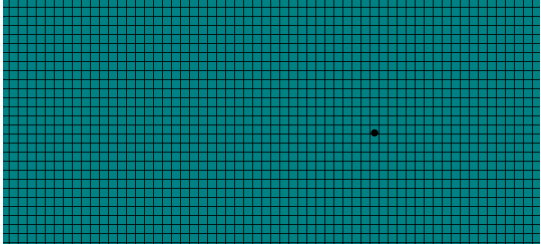
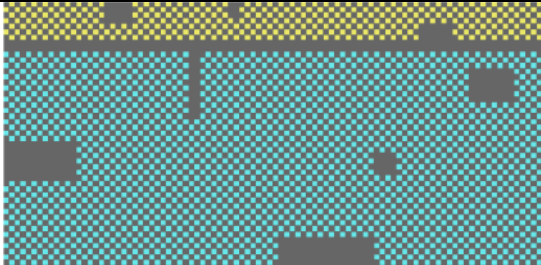
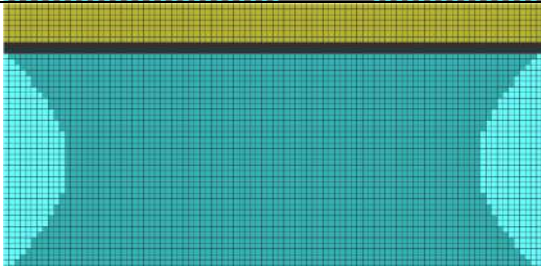
Check Item	Classification	Criteria
No Display	Major	
Missing Line	Major	
Pixel Short	Major	
Darker Pixel	Major	
Wrong Display	Major	
Un-uniform	Major	

# 11. Handling Precaution

## 11.1 Handling Precautions

- 1) Since the display panel is being made of glass, do not apply mechanical impacts such as dropping from a high position.
- 2) If the display panel is broken by some accident and the internal organic substance leaks out, be careful not to inhale nor lick the organic substance.
- 3) If pressure is applied to the display surface or its neighborhood of the OEL display module, the cell structure may be damaged and be careful not to apply pressure to these sections.
- 4) The polarizer covering the surface of the OEL display module is soft and easily scratched. Please be careful when handling the OEL display module.
- 5) When the surface of the polarizer of the OEL display module has soil, clean the surface. It takes advantage of by using following adhesion tape.

\* Scotch Mending Tape No. 810 or an equivalent.

Never try to breathe upon the soiled surface nor wipe the surface using cloth containing solvent such as ethyl alcohol, since the surface of the polarizer will become cloudy.

Also, pay attention that the following liquid and solvent may spoil the polarizer:

\* Water

\* Ketone

\* Aromatic Solvents

- 6) Hold OEL display module very carefully when placing OEL display module into the system housing.

Do not apply excessive stress or pressure to OEL display module. And, do not over bend the film with electrode pattern layouts. These stresses will influence the display performance. Also, secure sufficient rigidity for the outer cases.

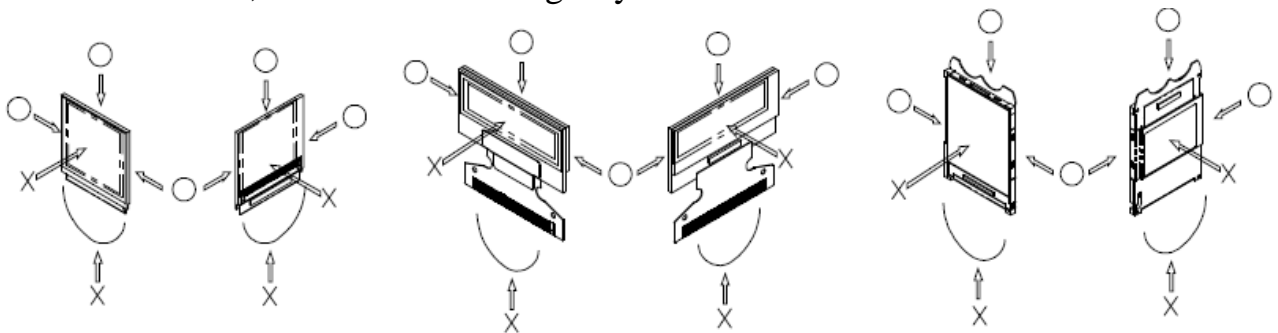

- 7) Do not apply stress to the driver IC and the surrounding molded sections.
  - 8) Do not disassemble nor modify the OEL display module.
  - 9) Do not apply input signals while the logic power is off.
  - 10) Pay sufficient attention to the working environments when handling OEL display modules to prevent occurrence of element breakage accidents by static electricity.
- \* Be sure to make human body grounding when handling OEL display modules.

- \* Be sure to ground tools to use or assembly such as soldering irons.
- \* To suppress generation of static electricity, avoid carrying out assembly work under dry environments.
- \* Protective film is being applied to the surface of the display panel of the OEL display module.

Be careful since static electricity may be generated when exfoliating the protective film.

11) Protection film is being applied to the surface of the display panel and removes the protection film before assembling it. At this time, if the OEL display module has been stored for a long period of time, residue adhesive material of the protection film may remain on the surface of the display panel after removed of the film. In such case, remove the residue material by the method introduced in the above Section 5).

12) If electric current is applied when the OEL display module is being dewed or when it is placed under high humidity environments, the electrodes may be corroded and be careful to avoid the above.

## **11.2 Storage Precautions**

1) When storing OEL display modules, put them in static electricity preventive bags avoiding exposure to direct sun light nor to lights of fluorescent lamps. and, also, avoiding high temperature and high humidity environment or low temperature (less than 0°C) environments. (We recommend you to store these modules in the packaged state when they were shipped).

At that time, be careful not to let water drops adhere to the packages or bags nor let dewing occur with them.

2) If electric current is applied when water drops are adhering to the surface of the OEL display module, when the OEL display module is being dewed or when it is placed under high humidity environments, the electrodes may be corroded and be careful about the above.

## **11.3 Designing Precautions**

1) The absolute maximum ratings are the ratings which cannot be exceeded for OEL display module, and if these values are exceeded, panel damage may be happen.

2) To prevent occurrence of malfunctioning by noise, pay attention to satisfy the VIL and VIH specifications and, at the same time, to make the signal line cable as short as possible.

3) We recommend you to install excess current preventive unit (fuses, etc.) to the power circuit (VDD).(Recommend value: 0.5A).

4) Pay sufficient attention to avoid occurrence of mutual noise interference with the neighboring devices.

5) As for EMI, take necessary measures on the equipment side basically.

6) When fastening the OEL display module, fasten the external plastic housing



section.

7) If power supply to the OEL display module is forcibly shut down by such errors as taking out the main battery while the OEL display panel is in operation, we cannot guarantee the quality of this OEL display module.

8) The electric potential to be connected to the rear face of the IC chip should be as follows: SSD1306 \* Connection (contact) to any other potential than the above may lead to rupture of the IC.

## **11.4 Precautions when disposing of the OEL display modules**

1) Request the qualified companies to handle industrial wastes when disposing of the OEL display modules. Or, when burning them, be sure to observe the environmental and hygienic laws and regulations.

## **11.5 Other Precautions**

1) When an OEL display module is operated for a long of time with fixed pattern may remain as an after image or slight contrast deviation may occur.

Nonetheless, if the operation is interrupted and left unused for a while, normal state can be restored. Also, there will be no problem in the reliability of the module.

2) To protect OEL display modules from performance drops by static electricity rapture, etc., do not touch the following sections whenever possible while handling the OEL display modules.

\* Pins and electrodes

\* Pattern layouts such as the FPC

3) With this OEL display module, the OEL driver is being exposed. Generally speaking, semiconductor elements change their characteristics when light is radiated according to the principle of the solar battery. Consequently, if this OEL driver is exposed to light, malfunctioning may occur.

\* Design the product and installation method so that the OEL driver may be shielded from light in actual usage.

\* Design the product and installation method so that the OEL driver may be shielded from light during the inspection processes.

4) Although this OEL display module stores the operation state data by the commands and the indication data, when excessive external noise, etc. enters into the module, the internal status may be changed. It therefore is necessary to take appropriate measures to suppress noise generation or to protect from influences of noise on the system design.

5) We recommend you to construct its software to make periodical refreshment of the operation statuses (re-setting of the commands and re-transference of the display data) to cope with catastrophic noise.

## **12.PackingMethod**

**TBD**