

1ACOS_S Series

1W - Single output AC-DC converter - Universal input - Non-isolated

AC-DC Converter

1 Watt

- ⊕ Wide input voltage range:
85~305VAC/70~430VDC
- ⊕ Operating temperature range:
-40°C to +85°C
- ⊕ Compact size, open frame
- ⊕ High reliability, green power
- ⊕ Industrial-grade design
- ⊕ Over output current protection
- ⊕ Short circuit protection (SCP)
- ⊕ EN62368 safety approval
- ⊕ Flexible selection of EMC
additional circuits, simplify
customer PCB layout

The 1ACOS_S series is a highly efficient green power AC-DC Converter series. It features wide input voltage range, accepting both DC and AC input voltage, high efficiency and low power consumption. The products are widely used in industrial control instrumentation, electric power applications and smart home type applications, the need to meet UL/CE safety certifications and lower demand for EMC compliance levels. For extremely harsh EMC environment, we recommend using the application circuit show of this datasheet.



Approval	Model	Package	Power [W]	Output [Vo]	Output [Io]	Ripple and Noise [mV, typ/max]	Efficiency [%, typ]	Capacitive load [μF, max]
UL/CE	1ACOS_05S	16.13 x 15.10 x 9.50 mm	1	5V	200mA	80/150	57	500

Input specifications

Input voltage range	85~305VAC, 70~430VDC	
Input frequency	47~63Hz	
Input current	115VAC • 0.12A (max)	277VAC • 0.06A (max)
Inrush current	115VAC • 25A (typ)	277VAC • 40A (typ)
Recommended eExternal input fuse (special package series include fuse)	1A/300V	
Hot plug	Unavailable	

Output specifications

Output voltage accuracy	±1.5% (typ), -7~+3% (max)
Line regulation (rated load)	±1.5% (typ)
Load regulation	±2.5% (typ)
Ripple & Noise* (p-p)	20MHz Bandwidth: 80mV (typ), 150mV (max)
Temperature coefficient	±0.12%/°C (typ)
Stand-by power consumption	0.3W (max)
Short circuit protection	Continuous, and auto resume
Over current protection	≥110%Io, self-recovery
Min. load	10%

Note:

- External electrolytic capacitors are required to modules, more details refer to typical applications;
- Unless otherwise specified, parameters in this datasheet were measured under the conditions of Ta=25°C, humidity<75%, nominal input voltage (115VAC and 230VAC) and rated output load;
- In order to improve the efficiency at light load, there will be audible noise generated, but it does not affect product performance and reliability.
- The module needs to be glued and fixed after assembly.
- All index testing methods in this datasheet are based on our company corporate standards;
- We can provide product customization service, please contact our technicians directly for specific information;
- Products are related to laws and regulations: see „Features“ and „EMC“;
- Our products shall be classified according to ISO14001 and related environmental laws and regulations, and shall be handled by qualified units.

* Ripple and Noise are measured by the method of parallel lines.

Example:

1ACOS_05S

1 = 1Watt; AC = AC-DC; OS= case style; 05= 5Vout; S= single output

1ACOS_S Series

1W - Single output AC-DC converter - Universal input - Non-isolated

Common specifications			
Operating temperature range	-40°C ~ +85°C		
Storage temperature range	-40°C ~ +105°C		
Power derating temperature range	-40°C to -20°C: 2%/°C +70°C to 85°C: 2.67%/°C 85VAC-110VAC: 0.8%/VAC 277VAC-305VAC: 1.1%/VAC		
Cooling	Free air convection		
Storage Humidity	95% RH (max)		
EMC / EMI / CE	CISPR32/EN55032, CLASS A (see typical application circuit) CISPR32/EN55032, CLASS B (see EMC recommended circuit)		
EMC / EMI / RE	CISPR32/EN55032, CLASS A (see typical application circuit) CISPR32/EN55032, CLASS B (see EMC recommended circuit)		
EMC / EMS / ESD	IEC/EN61000-4-2	Contact ±6KV / Air ±8KV (see typical application circuit)	perf. Criteria B
EMC / EMS / RS	IEC/EN61000-4-3	10V/m (see EMC recommended circuit)	perf. Criteria A
EMC / EMS / EFT*	IEC/EN61000-4-4	±2KV (see typical application circuit) ±4KV (see EMC recommended circuit)	perf. Criteria B perf. Criteria B
EMC / EMS / Surge Immunity	IEC/EN61000-4-5	line to line ±1KV (see typical application circuit)	perf. Criteria B
EMC / EMS / CS	IEC/EN61000-4-6	10 Vr.m.s (see EMC recommended circuit)	perf. Criteria A
EMC / EMS / Voltage dips, short and interruptions immunity	IEC/EN61000-4-11	0%-70% (see EMC recommended circuit)	perf. Criteria B
Safety standard	IEC62368/EN62368/UL62368		
Safety certification	EN62368		
Case material	UL94V-0		
Install	PCB		
MTBF	MIL-HDBK-217F@25°C >300,000h @25°C		
Weight	4.2g		

Typical characteristics

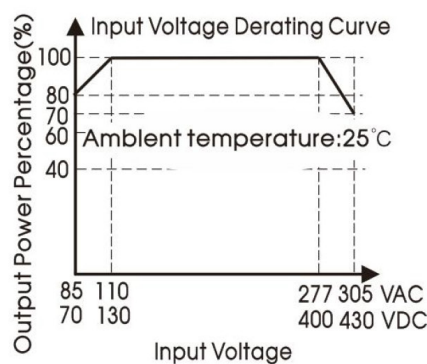
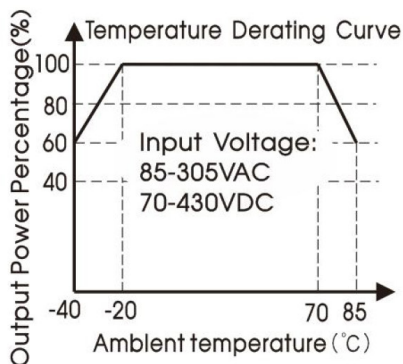

- ① With an AC input between 85 - 110VAC/277- 305VAC and a DC input between 70 - 130VDC/400 - 430VDC, the output power must be derated as per temperature derating curves;
- ② This product is suitable for applications using natural air cooling; for applications in closed environment please consult factory or one of our FAE.

1ACOS_S Series

1W - Single output AC-DC converter - Universal input - Non-isolated

Efficiency

Efficiency Vs Input Voltage (Full Load)

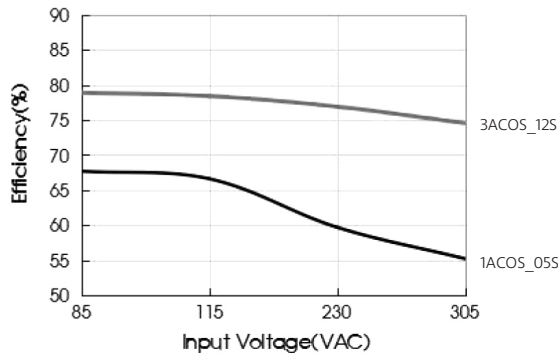

Efficiency Vs Output Load (Vin=230VAC)

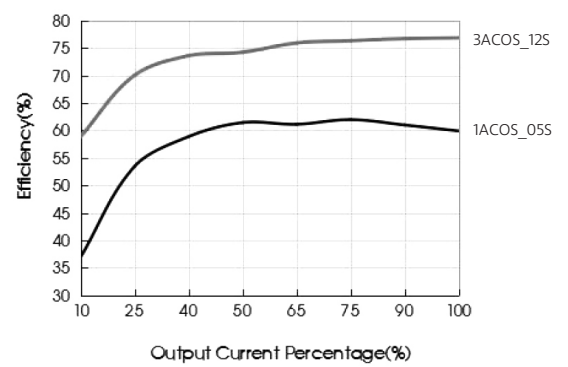

Typical application circuit

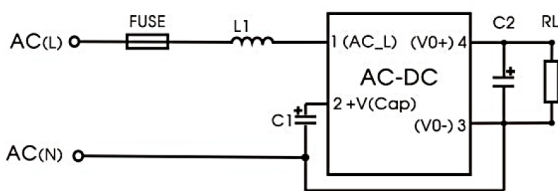

Model	FUSE (required)	C1 (required)	C2 (required)	L1 (required)
1ACOS_05S	1A/300V	10uF/400V:165-264VAC 10uF/450V:165-305VAC 22uF/400V: 85-264VAC 22uF/450V: 85-305VAC	220uF/16V	1.2mH

Note:

C1 is used as filter capacitor(required), if the surge immunity index is to be met, the C1 capacitor needs to be connected to 22uF.

Output filter: We recommend using an electrolytic capacitor with high frequency, high ripple current and low ESR rating for C2. Combined with L1, they form a pi-type filter circuit. Choose a Capacitor voltage rating with at least 20% margin, in other words not exceeding 80%.

EMC compliance recommended circuit

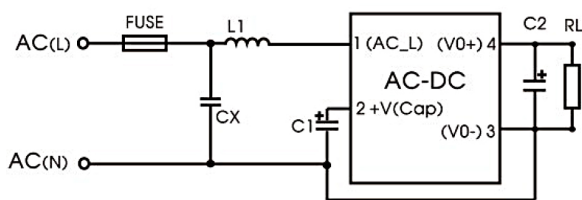

Components	Recommended parameter
CX	0.1uF/310VAC
L1	1.2mH
FUSE (required)	1A/300V, slow blow
C1 (required)	10uF/400V:165-264VAC 10uF/450V:165-305VAC 22uF/400V: 85-264VAC 22uF/450V: 85-305VAC
C2 (required)	2.2nF/400V

1ACOS_S Series

1W - Single output AC-DC converter - Universal input - Non-isolated

Mechanical dimensions

THIRD ANGLE PROJECTION 

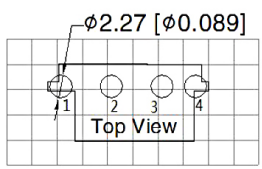
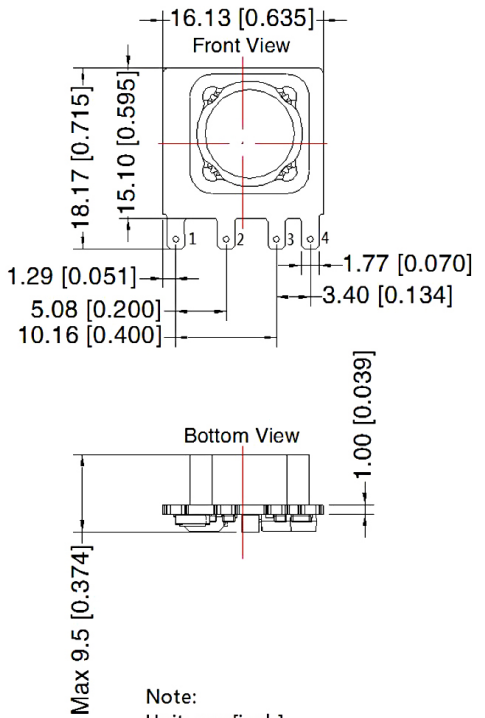

Note: Grid: 2.54*2.54mm

Pin-Out	
Pin	Function
1	AC(L)
2	+V(CAP)
3	AC(N)/-Vo
4	+Vo

Note:
 Unit: mm[inch]
 General tolerances: $\pm 1.0[\pm 0.04]$
 The layout of the device is for reference only,
 please refer to the actual product