



Part Number: D3C0780S

Electrical Specifications

Frequency Range (GHz):	0.698 – 0.800
Isolation (dB):	20 MIN
Insertion Loss (dB):	0.4 MAX
VSWR:	1.25:1 MIN
Forward Power (W):	300 AVG 750 PK

Mechanical/Environmental Specifications

Connector Type:	SMA
Connector Body:	Passivated stainless steel
Connector Pin:	Gold plated copper
Load Body:	Brass
Magnetic Shunt:	Nickel plated CRS
Operational Temp:	-20°C to +65°C
Weight (oz)	5.5 MAX

D3C0780S Dimensions

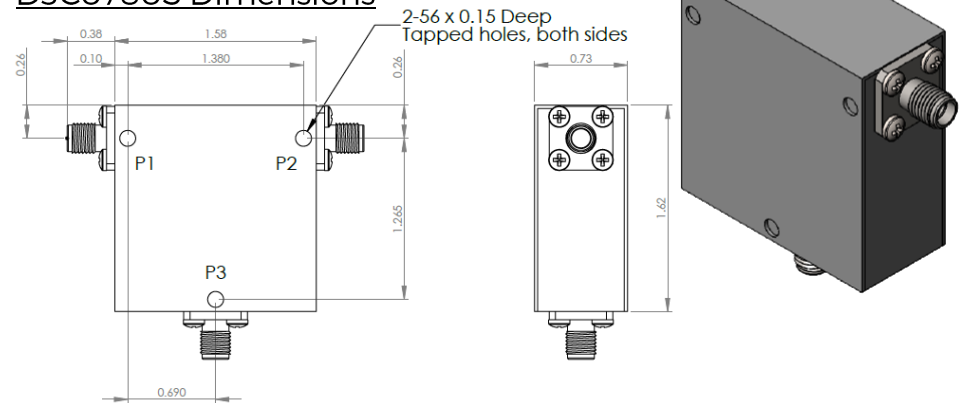

D3C0780S-3 Dimensions

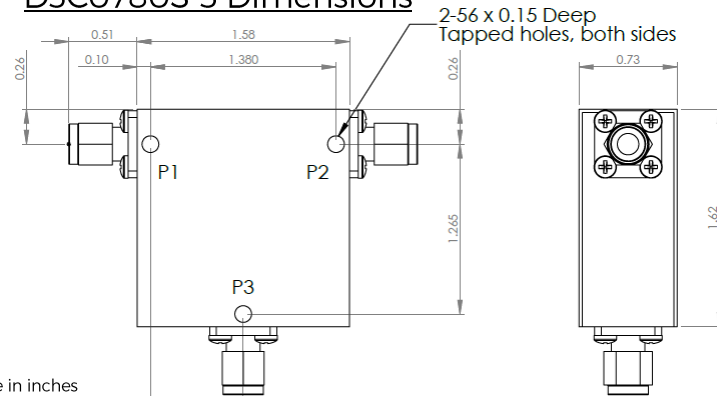

Dimensions are in inches
Tolerance

XX ±0.03
XXX ±0.010

Type of Device	PN Suffix	Connector Configuration Input / Output	PN Example
Single Junction Circulator 3-Port Device Port 1 / Port 2 / Port 3	No Dash	Female / Female / Female	D3C0780S
	-1	Male / Female / Female	D3C0780S-1
	-2	Female / Male / Female	D3C0780S-2
	-3	Male / Male / Male	D3C0780S-3
	-4	Female / Female / Male	D3C0780S-4
	-5	Male / Female / Male	D3C0780S-5
	-6	Male / Male / Female	D3C0780S-6
	-7	Female / Male / Male	D3C0780S-7



MEASURED DATA

Part Number: D3C0780S, P1→P2, P3 Terminated with 50Ω, +25°C

