

## LISA2-M-CLIP

~20° medium beam optimized for CREE XP-E.  
6.8 mm high variant with clip installation.

### SPECIFICATION:

Dimensions	Ø 9.9 mm
Height	6.8 mm
Fastening	glue, clips
ROHS compliant	yes ⓘ

### MATERIALS:

Component	Type	Material	Colour	Finish
LISA2-M	Single lens	PMMA	clear	
LISA2-HLD-CLIP16-XP	Holder	PC	black	

### ORDERING INFORMATION:

Component		Qty in box	MOQ	MPQ	Box weight (kg)
FP13030_LISA2-M-CLIP	Single lens	2000		100	1.4
» Box size:					



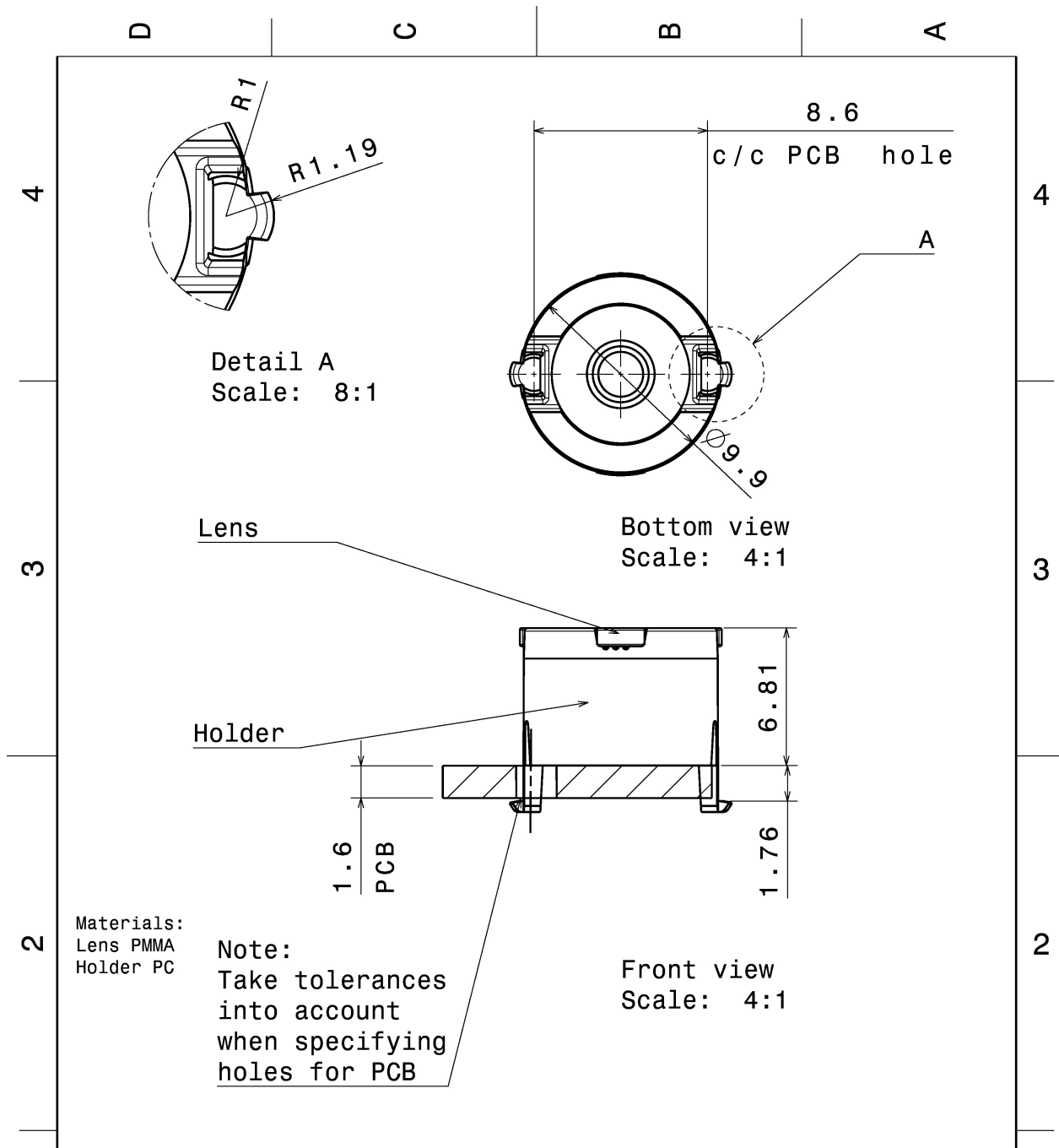

This drawing is our property. It can't be reproduced or communicated without our written agreement.				Ledil Oy Salorankatu 10 FIN-24240 SALO Finland	
DRAWN BY pl		DATE 20.06.2012		DRAWING TITLE Datasheet Lisa2-clip16-XT series Assy	
CHECKED BY sn		DATE 20.7.2011		SIZE A4	
DESIGNED BY pl		DATE 20.06.2012		DRAWING NUMBER	
		SCALE 4:1		WEIGHT (g)	
				REV 1	
				SHEET 1/1	

See also our general installation guide: [www.ledil.com/installation\\_guide](http://www.ledil.com/installation_guide)

#### OPTICAL RESULTS (MEASURED):

##### CREE LED

LED XP-G2  
 FWHM / FWTM 25.0° / 47.0°  
 Efficiency 89 %  
 Peak intensity 3.5 cd/m  
 LEDs/each optic 1  
 Light colour White  
 Required components:

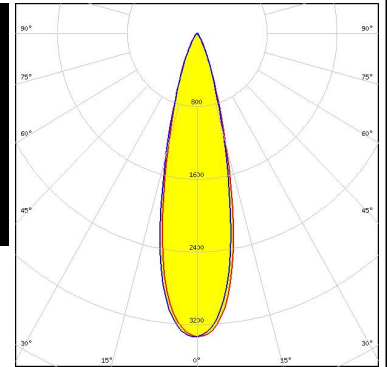

##### CREE LED

LED XT-E  
 FWHM / FWTM 26.0° / 49.0°  
 Efficiency 89 %  
 Peak intensity 3.3 cd/m  
 LEDs/each optic 1  
 Light colour White  
 Required components:

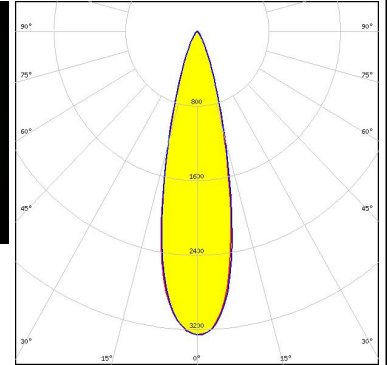

##### LUMILEDS

LED LUXEON T  
 FWHM / FWTM 28.0° / 54.0°  
 Efficiency 87 %  
 Peak intensity 2.7 cd/m  
 LEDs/each optic 1  
 Light colour White  
 Required components:

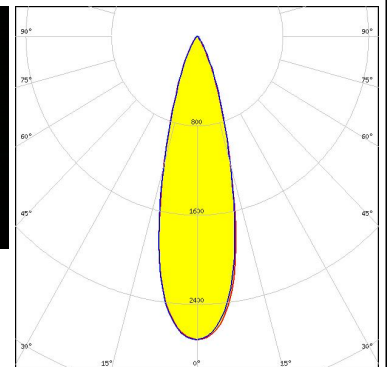
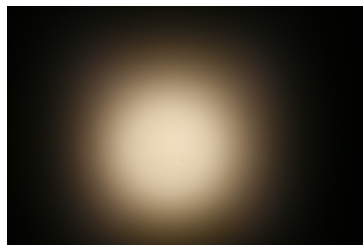

##### LUMILEDS

LED LUXEON TX  
 FWHM / FWTM 26.0° / 51.0°  
 Efficiency 88 %  
 Peak intensity 3.4 cd/m  
 LEDs/each optic 1  
 Light colour White  
 Required components:

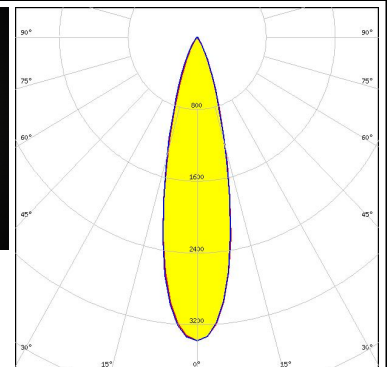
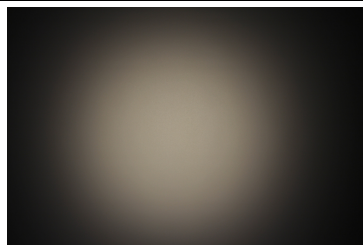

#### OPTICAL RESULTS (MEASURED):

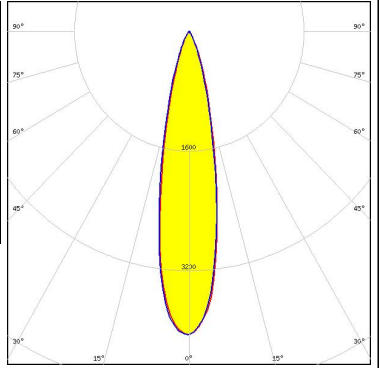
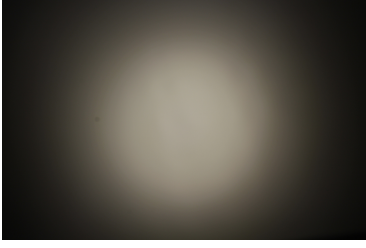
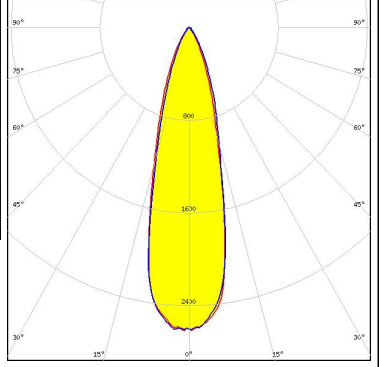
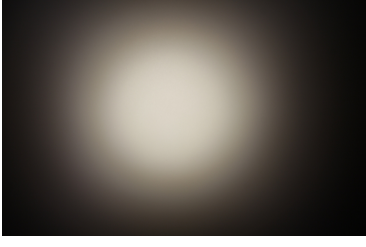
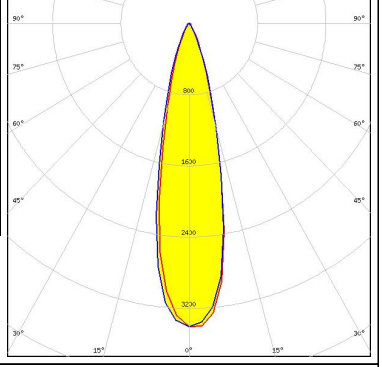
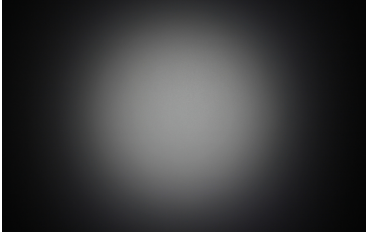
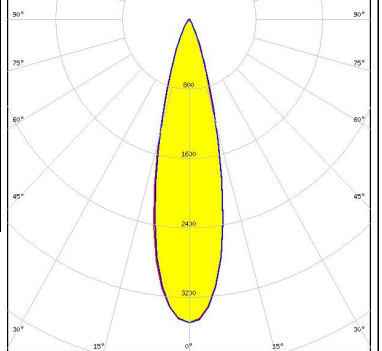
<p><b>NICHIA</b></p> <p>LED NCSxx19B            FWHM / FWTM 23.0° / 46.0°            Efficiency 85 %            Peak intensity 4.1 cd/lm            LEDs/each optic 1            Light colour White            Required components:</p>		
<p><b>NICHIA</b></p> <p>LED NVSxx19B/NVSxx19C            FWHM / FWTM 27.0° / 56.0°            Efficiency 86 %            Peak intensity 2.6 cd/lm            LEDs/each optic 1            Light colour White            Required components:</p>		
<p><b>OSRAM</b>  <small>Opto Semiconductors</small></p> <p>LED OSLON Square EC            FWHM / FWTM 26.0° / 49.0°            Efficiency 85 %            Peak intensity 3.4 cd/lm            LEDs/each optic 1            Light colour White            Required components:</p>		
<p><b>SAMSUNG</b></p> <p>LED LH351Z            FWHM / FWTM 26.0° / 50.0°            Efficiency 87 %            Peak intensity 3.5 cd/lm            LEDs/each optic 1            Light colour White            Required components:</p>		

#### OPTICAL RESULTS (SIMULATED):

##### LUMILEDS

LED LUXEON H50-2  
 FWHM / FWTM 24.0° / 52.0°  
 Efficiency 89 %  
 Peak intensity 3.1 cd/lm  
 LEDs/each optic 1  
 Light colour White  
 Required components:

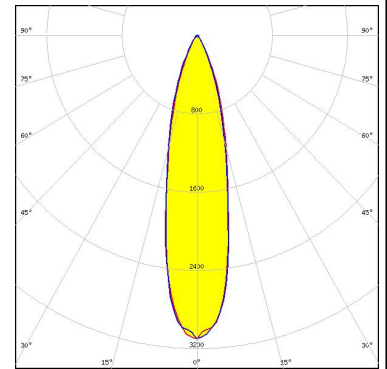

##### LUMILEDS

LED LUXEON IR Compact  
 FWHM / FWTM 14.0° / 29.0°  
 Efficiency 82 %  
 LEDs/each optic 1  
 Light colour White  
 Required components:

##### OSRAM

Opto Semiconductors

LED OSOLON Square CSSRM2/CSSRM3  
 FWHM / FWTM 21.0° / 44.0°  
 Efficiency 91 %  
 Peak intensity 4.4 cd/lm  
 LEDs/each optic 1  
 Light colour White  
 Required components:

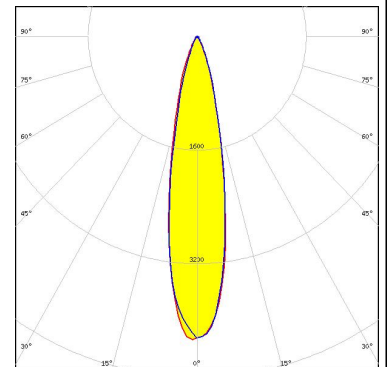

##### OSRAM

Opto Semiconductors

LED SFH 4770S  
 FWHM / FWTM 12.0° / 30.0°  
 Efficiency 90 %  
 LEDs/each optic 1  
 Light colour IR  
 Required components:

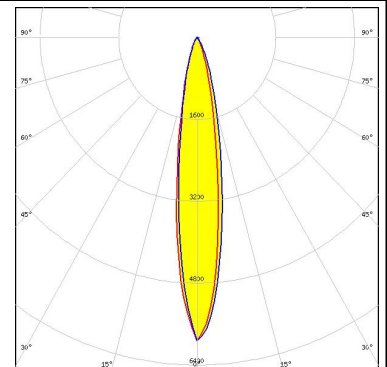
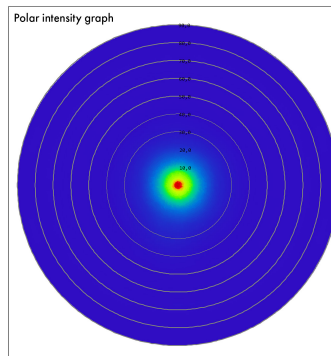

### OPTICAL RESULTS (SIMULATED):

#### SAMSUNG

LED LH351B  
FWHM / FWTM 27.0° / 54.0°  
Efficiency 89 %  
Peak intensity 2.8 cd/lm  
LEDs/each optic 1  
Light colour White  
Required components:

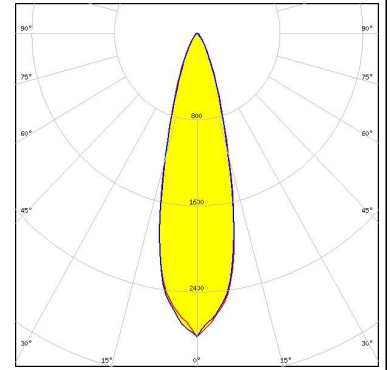

SEOUL SEMICONDUCTOR

LED Z8Y22P  
FWHM / FWTM 25.0° / 56.0°  
Efficiency 84 %  
Peak intensity 2.7 cd/lm  
LEDs/each optic 1  
Light colour White  
Required components:

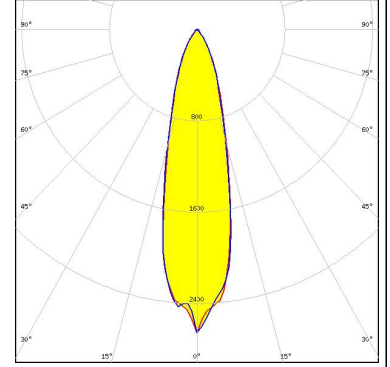

### GENERAL INFORMATION:

NOTE: The typical beam angle will be changed by different color, chip size and chip position tolerance. The typical total beam angle is the full angle measured where the luminous intensity is half of the peak value.

### MATERIALS:

As part of our continuous research and improvement processes, and to ensure the best possible quality and availability of our products, LEDiL reserves the right to change material grades without notice.

### PRODUCT DATA USER AGREEMENT AND DISCLAIMER:

The measured data in the provided downloadable LEDiL Product Datasheets and Mechanical 2D-Drawings is rounded and provided as reference for planning. LEDiL Oy's optical specifications have been verified by conducting performance testing of the products in accordance with the company's quality system. The reported data are averaged results of multiple measurements with typical variation. LEDiL Oy reserves the right to without prior notification make changes and improvements to its products.

LEDiL Oy assumes neither warranty, nor guarantee nor any other liability of any kind for the contents and correctness of the provided data. The provided data has been generated with highest diligence but the provided data may in reality not represent the complete possible variation range of all intrinsic parameters. Therefore, in certain cases a deviation from the provided data could occur.

LEDiL Oy reserves the right to undertake technical changes of its products without further notification which could lead to changes in the provided data. LEDiL Oy assumes no liability of any kind for the possible deviation from any provided data or any other damage resulting from the usage of the provided data.

The user agrees to this disclaimer and user agreement with the download or usage of the provided files.

#### LEDiL Oy

Joensuunkatu 13  
FI-24240 SALO  
Finland

#### LEDiL Inc.

228 West Page Street  
Suite D  
Sycamore IL 60178  
USA

#### Ledil Optics Technology (Shenzhen) Co., Ltd.

# 405 , Block B  
Casic Motor Building  
Shenzhen 518057  
P.R.CHINA

#### Local sales and technical support

[www.ledil.com/  
where\\_to\\_buy](http://www.ledil.com/where_to_buy)

#### Shipping locations

Salo, Finland  
Hong Kong, China

#### Distribution Partners

[www.ledil.com/  
where\\_to\\_buy](http://www.ledil.com/where_to_buy)