

- NOTES:
1. MATERIAL: NYLON 6/6, 94V-2.
 2. FINISH: SEE CRIMP TERMINAL DRAWING.
 3. THIS PRODUCT CONFORMS TO PRODUCT SPECIFICATION PS-08-50.
 4. PACKAGING: BULK PER PK-2574-001
 5. CONNECTOR TO BE USED WITH CRIMP TERMINALS:
 - 2478: 18-24 GAGE WIRE, .110/(2.79) MAX. INSULATION DIAMETER.
 - 2578: 22-26 GAGE WIRE, .065/(1.65) MAX. INSULATION DIAMETER.
 - 2878: 18-20 GAGE WIRE, .110/(2.79) MAX. INSULATION DIAMETER.
 6. DIMENSIONS GIVEN ACROSS CENTERLINES ARE SYMMETRICAL ABOUT THOSE CENTERLINES WITHIN ONE HALF THE TOTAL TOLERANCE.
 7. CIRCUIT 1 I.D. PRESENT ON ALL PARTS. LAST CIRCUIT I.D. MAY OR MAY NOT BE PRESENT.
 8. PART CONFORMS TO CLASS B REQUIREMENTS OF COSMETIC SPECIFICATION PS-45499-002
 9. SLOTS MAY OR MAY NOT BE PRESENT ON PART.

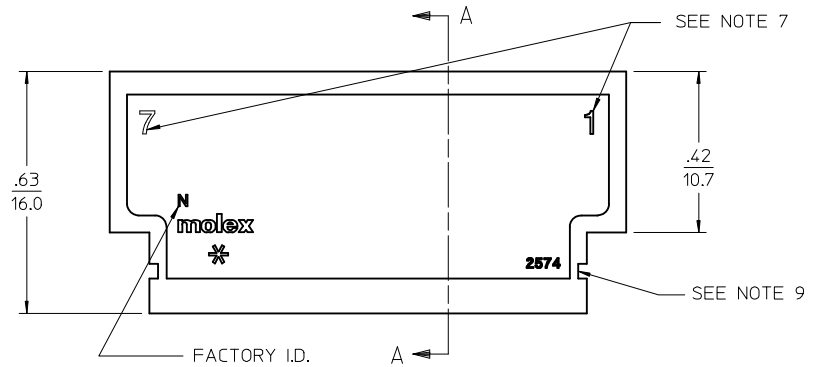

SECTION A-A

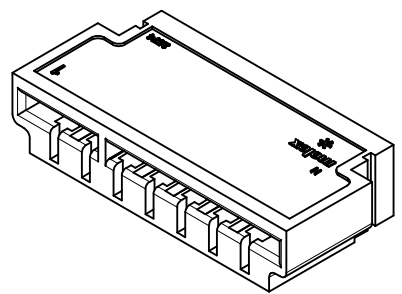
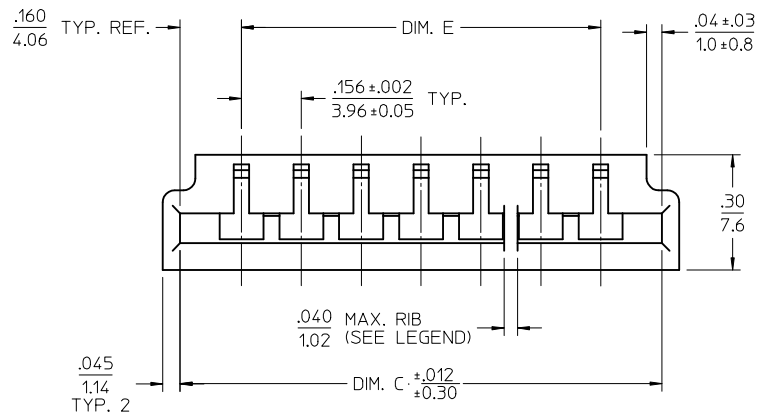
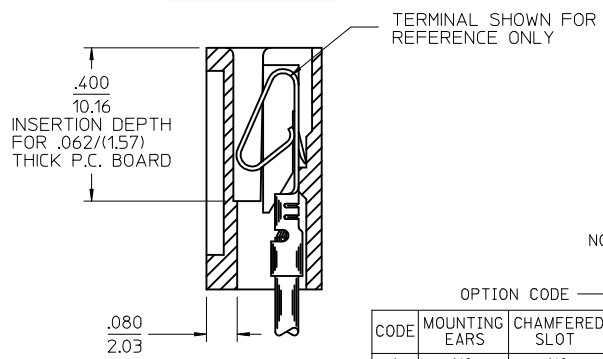

2574 - N * * *
 NO. OF CIRCUITS
 COLOR CODE
 BLANK=NATURAL
 BK=BLACK

OPTION CODE

CODE	MOUNTING EARS	CHAMFERED SLOT	PCB THK	MOUNTING HOLES
A	NO	NO	.062	NO
B	YES	NO	.062	NO
C	NO	YES	.062	NO
D	YES	YES	.062	NO
E	NO	NO	.032	NO
F	YES	NO	.062	YES

- RIB LOCATION CODE (BETWEEN CKTS)
- 1 = NONE
 - 2 = 2-3
 - 3 = 3-4
 - 4 = 5-6
 - 5 = 3-4, 5-6
 - 6 = 4-5, 7-8
 - 7 = 5-6, 8-9
 - 8 = 5-6, 10-11
 - 9 = 4-5, 7-8, 11-12
 - 10 = 5-6, 10-11, 14-15
 - 11 = 5-6, 10-11, 15-16
 - 12 = 5-6, 11-12, 16-17
 - 13 = 5-6, 11-12, 17-18
 - 14 = 4-5, 7-8, 11-12, 15-16
 - 15 = 4-5, 8-9, 12-13, 16-17, 20-21
 - 16 = 5-6, 11-12, 18-19

3 CIRCUIT ONLY

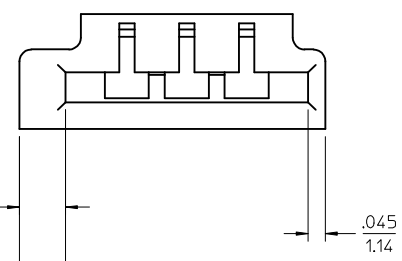

<p>NOTE 7</p> <p>EC NO: UCP2015-0556 2014/08/07 DRWN:JDOX 2014/08/08 CHKD:MKIPPER 2014/08/29 APPR:FSMITH</p> <p>REV: D4</p>	<p>QUALITY SYMBOLS</p> <p>▽=0</p> <p>▽=0</p> <p>▽=0</p>	<p>GENERAL TOLERANCES (UNLESS SPECIFIED)</p> <table border="1"> <thead> <tr> <th></th> <th>mm</th> <th>INCH</th> </tr> </thead> <tbody> <tr> <td>4 PLACES</td> <td>± .010</td> <td>± .004</td> </tr> <tr> <td>3 PLACES</td> <td>± .015</td> <td>± .005</td> </tr> <tr> <td>2 PLACES</td> <td>± 0.25</td> <td>± .010</td> </tr> <tr> <td>1 PLACE</td> <td>± 0.36</td> <td>± .014</td> </tr> <tr> <td>0 PLACE</td> <td>± .010</td> <td>± .004</td> </tr> </tbody> </table> <p>ANGULAR ± 3°</p> <p>DRAFT WHERE APPLICABLE MUST REMAIN WITHIN DIMENSIONS</p>		mm	INCH	4 PLACES	± .010	± .004	3 PLACES	± .015	± .005	2 PLACES	± 0.25	± .010	1 PLACE	± 0.36	± .014	0 PLACE	± .010	± .004	<p>DIMENSION STYLE</p> <p>IN/MM</p> <p>DRAWN BY PEREZ-ARGUET DATE 1988/03/02</p> <p>CHECKED BY PATEL DATE 1988/03/02</p> <p>APPROVED BY FSMITH DATE 2012/08/13</p> <p>MATERIAL NO. SEE CHART</p>	<p>SCALE 4:1</p> <p>DESIGN UNITS INCH</p> <p>THIRD ANGLE PROJECTION</p>	<p>EDGE CARD CONNECTOR</p> <p>.156/(3.96) CENTERS</p> <p>CRIMP TYPE-2574 SERIES</p> <p>molex</p> <p>SD-2574</p>	<p>SHEET NO. 1 OF 3</p>
		mm	INCH																					
	4 PLACES	± .010	± .004																					
	3 PLACES	± .015	± .005																					
2 PLACES	± 0.25	± .010																						
1 PLACE	± 0.36	± .014																						
0 PLACE	± .010	± .004																						
<p>DRAFT WHERE APPLICABLE MUST REMAIN WITHIN DIMENSIONS</p>			<p>DOCUMENT NO.</p>	<p>THIS DRAWING CONTAINS INFORMATION THAT IS PROPRIETARY TO MOLEX INCORPORATED AND SHOULD NOT BE USED WITHOUT WRITTEN PERMISSION</p>																				
			<p>SIZE C</p>																					

3 CIRCUIT ONLY

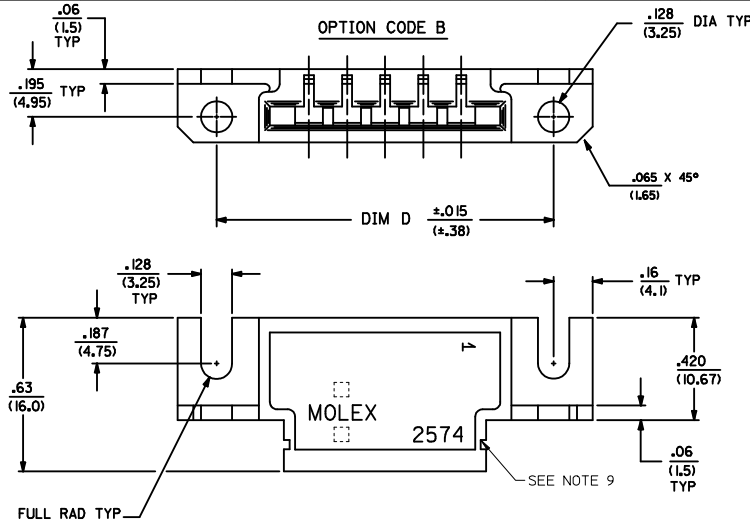
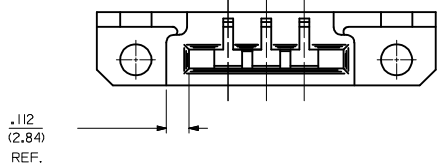

OPTION CODE F

SAME AS OPTION B EXCEPT AS SHOWN

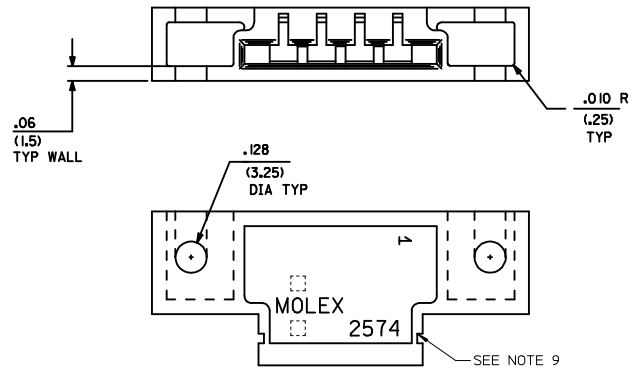

NO. OF CKT'S	DIM. C	DIM. D	DIM. E	DIM. A
3	.632 (16.05)	1.143 (29.03)	.312±.002 (7.92±.05)	.618 (15.70)
4	.788 (20.02)	1.224 (31.09)	.468±.002 (11.89±.05)	.774 (19.66)
5	.944 (23.98)	1.380 (35.05)	.624±.003 (15.85±.08)	.922 (23.42)
6	1.100 (27.94)	1.536 (39.01)	.780±.003 (19.81±.08)	1.078 (27.38)
7	1.256 (31.90)	1.692 (42.98)	.936±.003 (23.77±.08)	1.232 (31.29)
8	1.412 (35.86)	1.848 (46.94)	1.092±.004 (27.74±.10)	1.388 (35.26)
9	1.568 (39.83)	2.004 (50.90)	1.248±.004 (31.70±.10)	1.544 (39.22)
10	1.724 (43.79)	2.160 (54.86)	1.404±.006 (35.66±.15)	1.700 (43.18)
11	1.880 (47.75)	2.316 (58.83)	1.560±.006 (39.62±.15)	1.854 (47.09)
12	2.036 (51.71)	2.472 (62.79)	1.716±.006 (43.59±.15)	2.010 (51.05)
13	2.192 (55.68)	2.628 (66.75)	1.872±.006 (47.55±.15)	2.164 (54.97)
14	2.348 (59.64)	2.784 (70.71)	2.028±.007 (51.51±.18)	2.318 (58.88)
15	2.504 (63.60)	2.940 (74.68)	2.184±.007 (55.47±.18)	2.474 (62.84)
16	2.660 (67.56)	3.096 (78.64)	2.340±.007 (59.44±.18)	2.631 (66.83)
17	2.816 (71.53)	3.252 (82.60)	2.496±.008 (63.40±.20)	2.784 (70.71)
18	2.972 (75.49)	3.408 (86.56)	2.652±.009 (67.36±.23)	2.954 (75.03)
19	3.128 (79.45)	3.564 (90.53)	2.808±.009 (71.32±.23)	3.095 (78.61)
20	3.284 (83.41)	3.720 (94.49)	2.964±.009 (75.29±.23)	3.251 (82.58)
21	3.440 (87.38)	3.876 (98.45)	3.120±.010 (79.25±.25)	3.407 (86.54)
22	3.596 (91.34)	4.032 (102.41)	3.276±.011 (83.21±.25)	3.562 (90.47)
23	3.752 (95.30)	4.188 (106.38)	3.432±.011 (87.17±.28)	3.716 (94.39)
24	3.908 (99.26)	4.344 (110.34)	3.588±.012 (91.14±.30)	3.871 (98.32)

OPTION CODE C

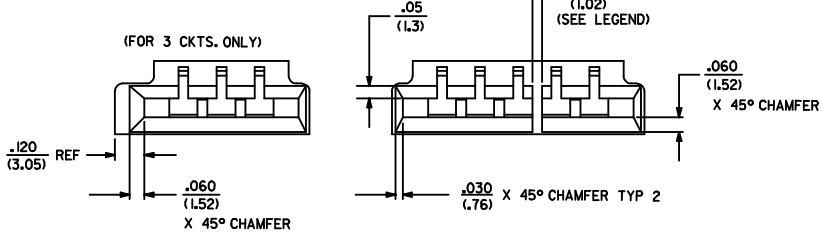

OPTION CODE E

FOR .032 THK PCB

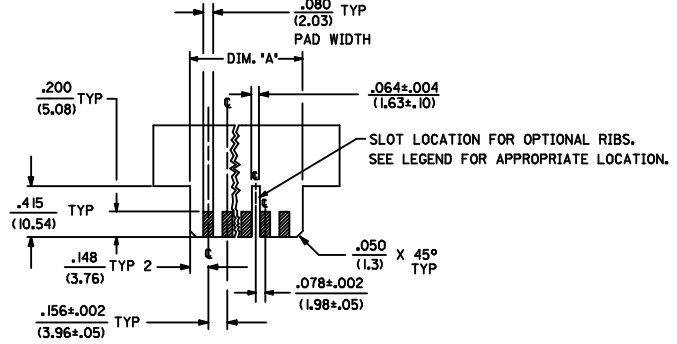
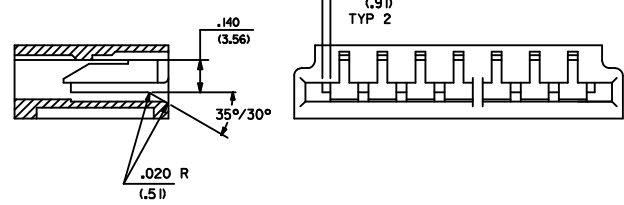

OPTION CODE D



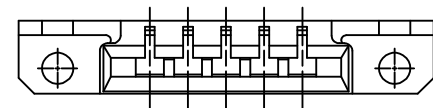



(SEE OPTIONS B & C FOR DIMENSIONS)



SEE SHEET 1 EC NO: UCP2015-0556 DRAWN: JDOX 2014/08/07 CHKD: HKP 2014/08/08 APPR: FSMTH 2014/08/29 D4	QUALITY SYMBOLS ▽=0 ▽=0 ▽=0	GENERAL TOLERANCES (UNLESS SPECIFIED)	DIMENSION STYLE IN/MM	SCALE ---	DESIGN UNITS INCH	THIRD ANGLE PROJECTION
		mm INCH	DRAWN BY DATE PEREZ-ARGUET 1988/03/02	TITLE EDGE CARD CONNECTOR .156/(3.96) CENTERS CRIMP TYPE-2574 SERIES		
		4 PLACES ± --- ± --- 3 PLACES ± --- ± .010 2 PLACES ± 0.25 ± .015 1 PLACE ± 0.36 ± --- 0 PLACE ± --- ± ---	CHECKED BY DATE PATEL 1988/03/02	APPROVED BY DATE FSMTH 2012/08/13		
		ANGULAR ± 3° DRAFT WHERE APPLICABLE MUST REMAIN WITHIN DIMENSIONS	MATERIAL NO. SEE CHART	DOCUMENT NO. SD-2574	SHEET NO. 2 OF 3	

THIS DRAWING CONTAINS INFORMATION THAT IS PROPRIETARY TO MOLEX INCORPORATED AND SHOULD NOT BE USED WITHOUT WRITTEN PERMISSION

13		12		11		10		9		8		7		6		5		4		3		2		1			
2574-NA*				2574-NB*				2574-NC*				2574-ND*				2574-NE*				2574-NF*							
PART NO.		ENG. NO. (SUFFIX ONLY)		PART NO.		ENG. NO. (SUFFIX ONLY)		PART NO.		ENG. NO. (SUFFIX ONLY)		PART NO.		ENG. NO. (SUFFIX ONLY)		PART NO.		ENG. NO. (SUFFIX ONLY)		PART NO.		ENG. NO. (SUFFIX ONLY)		PART NO.		ENG. NO. (SUFFIX ONLY)	
09-01-6031	-3A1	09-01-7031	-3B1	09-01-6038	-3C1	09-01-6038	-3C1													09-01-7065	-6F1-BK	09-01-7087	-8F1-BK				
09-01-6041	-4A1	09-01-7041	-4B1	09-01-6048	-04C1																						
09-01-6051	-5A1	09-01-7051	-5B1	09-01-6088	-08C1																						
09-01-6064	-6A1	09-01-7064	-6B1		-20C1																						
09-01-6081	-8A1D	09-01-7081	-8B1																								
		09-01-7069	-6B1D																								
09-01-6055	-5A2		-8B1D																								
09-01-6061	-6A2	09-01-7061	-6B2																								
09-01-6085	-8A2	09-01-7085	-8B2																								
09-01-6095	-9A2	09-01-7095	-9B2																								
09-01-6071	-7A3	09-01-7071	-7B3																								
09-01-6086	-8A3	09-01-7086	-8B3																								
09-01-6083	-8A4	09-01-7083	-8B4																								
09-01-6094	-9A4	09-01-7094	-9B4																								
09-01-6091	-9A5	09-01-7091	-9B5																								
09-01-6101	-10A6	09-01-7101	-10B6																								
09-01-6121	-12A7	09-01-7121	-12B7																								
09-01-6129	-12A4	09-01-7129	-12B4																								
09-01-6181	-18A8	09-01-7181	-18B8																								
09-01-6151	-15A9	09-01-7151	-15B9																								
09-01-6161	-16A9	09-01-7161	-16B9																								
09-01-6171	-17A10	09-01-7171	-17B10																								
09-01-6211	-21A11	09-01-7211	-21B11																								
09-01-6224	-22A12	09-01-7224	-22B12																								
09-01-6221	-22A13	09-01-7221	-22B13																								
09-01-6191	-19A14	09-01-7191	-19B14																								
09-01-6241	-24A15	09-01-7241	-24B15																								
09-01-7222	-22A16		-6B1-BK																								

SEE SHEET 1 EC NO: UCP2015-0556 DRWN:JDFX 2014/08/07 CHKD:HKIPPER 2014/08/08 APPR:FSMITH 2014/08/29	QUALITY SYMBOLS  = 0  = 0  = 0	GENERAL TOLERANCES (UNLESS SPECIFIED)		DIMENSION STYLE IN/MM		SCALE ---	DESIGN UNITS INCH	 THIRD ANGLE PROJECTION	
		4 PLACES ± --- ± ---	DRAWN BY PEREZ-ARGUET	DATE 1988/03/02	TITLE EDGE CARD CONNECTOR .156/(3.96) CENTERS CRIMP TYPE-2574 SERIES				
		3 PLACES ± --- ±.010	CHECKED BY PATEL	DATE 1988/03/02					
		2 PLACES ± 0.25 ±.015	APPROVED BY FSMITH	DATE 2012/08/13	MATERIAL NO. SEE CHART	DOCUMENT NO. SD-2574	SHEET NO. 3 OF 3		
1 PLACE ± 0.36 ± ---	DRAFT WHERE APPLICABLE MUST REMAIN WITHIN DIMENSIONS		SIZE 	THIS DRAWING CONTAINS INFORMATION THAT IS PROPRIETARY TO MOLEX INCORPORATED AND SHOULD NOT BE USED WITHOUT WRITTEN PERMISSION					
0 PLACE ± --- ± ---									