

## IR Receiver Modules for Remote Control Systems

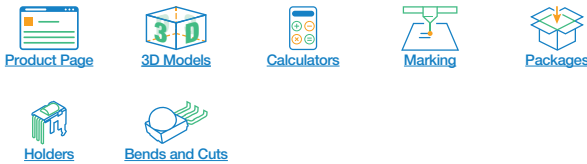

19026

### LINKS TO ADDITIONAL RESOURCES



### DESCRIPTION

The TSOP98... series devices are the latest generation miniaturized IR receiver modules for infrared remote control systems. This series provides improvements in sensitivity to remote control signals in dark ambient as well as in sensitivity in the presence of optical disturbances e.g. from CFLs.

The devices contain a PIN diode and a preamplifier assembled on a lead frame. The epoxy package contains an IR filter. The demodulated output signal can be directly connected to a microprocessor for decoding.

The TSOP982.. and TSOP984.. series devices are designed to receive long burst codes (10 or more carrier cycles per burst). The third digit designates the AGC level (AGC2 or AGC4) and the last two digits designate the band-pass frequency (see table below). The higher the AGC, the better noise is suppressed, but the lower the code compatibility. AGC2 provides basic noise suppression and AGC4 provides enhanced noise suppression. Generally, we advise to select the highest AGC that satisfactorily receives the desired remote code.

These components have not been qualified to automotive specifications.

### FEATURES

- Improved dark sensitivity
- Improved immunity against optical noise
- Very low supply current
- Photo detector and preamplifier in one package
- Internal filter for PCM frequency
- Low supply voltage: 2.0 V to 3.6 V
- Insensitive to supply voltage ripple and noise
- Material categorization: for definitions of compliance please see [www.vishay.com/doc?99912](http://www.vishay.com/doc?99912)



**RoHS**  
COMPLIANT  
HALOGEN  
**FREE**  
**GREEN**  
(5-2008)

### MECHANICAL DATA

1 = OUT, 2 = GND, 3 =  $V_S$

### ORDERING CODE

TSOP98... - 1500 pieces in bags

### BLOCK DIAGRAM

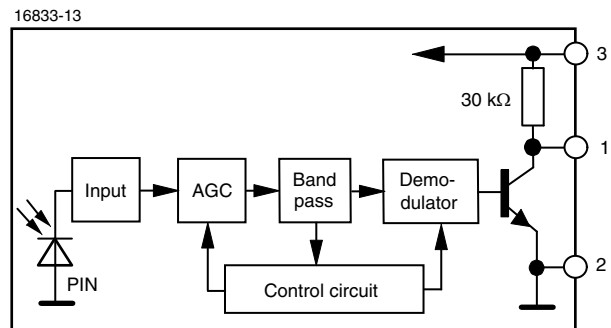

### APPLICATION CIRCUIT

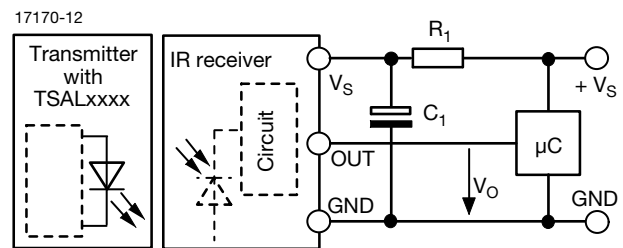

$R_1$  and  $C_1$  recommended to reduce supply ripple for  $V_S < 2.2$  V



PARTS TABLE			
AGC		BASIC NOISE SUPPRESSION (AGC2)	ENHANCED NOISE SUPPRESSION (AGC4)
Carrier frequency	30 kHz	TSOP98230	TSOP98430
	33 kHz	TSOP98233	TSOP98433
	36 kHz	TSOP98236	TSOP98436 <sup>(6)</sup>
	38 kHz	TSOP98238	TSOP98438 <sup>(9)</sup>
	40 kHz	TSOP98240 <sup>(11)</sup>	TSOP98440
	56 kHz	TSOP98256 <sup>(1)</sup>	TSOP98456 <sup>(7)(8)</sup>
Package		Minicast	
Pinning		1 = OUT, 2 = GND, 3 = V <sub>S</sub>	
Dimensions (mm)		5.0 W x 6.95 H x 4.8 D	
Mounting		Leaded	
Application		Remote control	
Best choice for		(1) Cisco (2) Mitsubishi (3) NEC (4) Panasonic (5) RC-5 (6) RC-6 (7) RCA (8) r-step (9) Sejin 4PPM (10) Sharp (11) Sony	

Notes

- 30 kHz and 33 kHz only available on written request
- See datasheet for TSOP986.. for preferred devices for <sup>(2)(3)(4)(5)(10)</sup>

ABSOLUTE MAXIMUM RATINGS				
PARAMETER	TEST CONDITION	SYMBOL	VALUE	UNIT
Supply voltage		V <sub>S</sub>	-0.3 to +3.6	V
Supply current		I <sub>S</sub>	3	mA
Output voltage		V <sub>O</sub>	-0.3 to (V <sub>S</sub> + 0.3)	V
Output current		I <sub>O</sub>	5	mA
Junction temperature		T <sub>j</sub>	100	°C
Storage temperature range		T <sub>stg</sub>	-25 to +85	°C
Operating temperature range		T <sub>amb</sub>	-25 to +85	°C
Power consumption	T <sub>amb</sub> ≤ 85 °C	P <sub>tot</sub>	10	mW
Soldering temperature	t ≤ 10 s, 1 mm from case	T <sub>sd</sub>	260	°C

Note

- Stresses beyond those listed under “Absolute Maximum Ratings” may cause permanent damage to the device. This is a stress rating only and functional operation of the device at these or any other conditions beyond those indicated in the operational sections of this specification is not implied. Exposure to absolute maximum rating conditions for extended periods may affect the device reliability

ELECTRICAL AND OPTICAL CHARACTERISTICS (T <sub>amb</sub> = 25 °C, unless otherwise specified)						
PARAMETER	TEST CONDITION	SYMBOL	MIN.	TYP.	MAX.	UNIT
Supply current	E <sub>v</sub> = 0, V <sub>S</sub> = 3.3 V	I <sub>SD</sub>	0.25	0.37	0.45	mA
	E <sub>v</sub> = 40 klx, sunlight	I <sub>SH</sub>	-	0.50	-	mA
Supply voltage		V <sub>S</sub>	2.0	-	3.6	V
Transmission distance	E <sub>v</sub> = 0, test signal see Fig. 1, IR diode TSAL6200, I <sub>F</sub> = 50 mA	d	-	24	-	m
Output voltage low	I <sub>OSL</sub> = 0.5 mA, E <sub>e</sub> = 0.7 mW/m <sup>2</sup> , test signal see Fig. 1	V <sub>OSL</sub>	-	-	100	mV
Minimum irradiance	Test signal: NEC code	E <sub>e min.</sub>	-	0.12	0.25	mW/m <sup>2</sup>
Maximum irradiance	t <sub>pi</sub> - 4/f <sub>0</sub> < t <sub>po</sub> < t <sub>pi</sub> + 4/f <sub>0</sub> , test signal see Fig. 1	E <sub>e max.</sub>	30	-	-	W/m <sup>2</sup>
Directivity	Angle of half transmission distance	φ <sub>1/2</sub>	-	± 45	-	°

**TYPICAL CHARACTERISTICS** ( $T_{amb} = 25\text{ }^{\circ}\text{C}$ , unless otherwise specified)



Fig. 1 - Output Delay and Pulse-Width

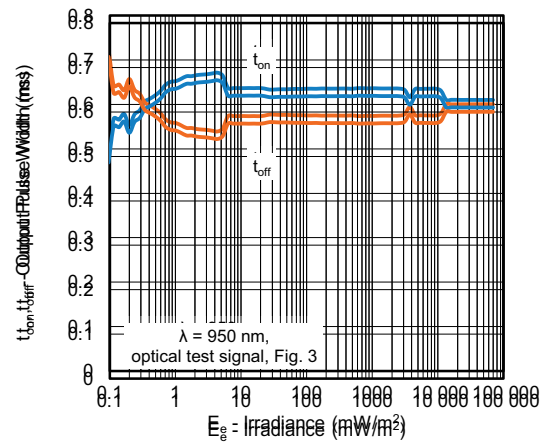

Fig. 4 - Pulse-Width vs. Irradiance in Dark Ambient

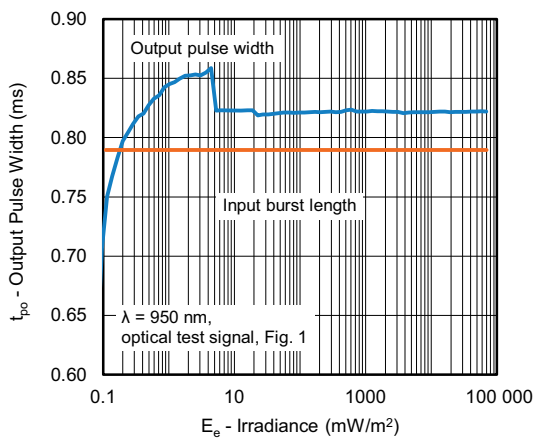

Fig. 2 - Pulse-Width vs. Irradiance in Dark Ambient

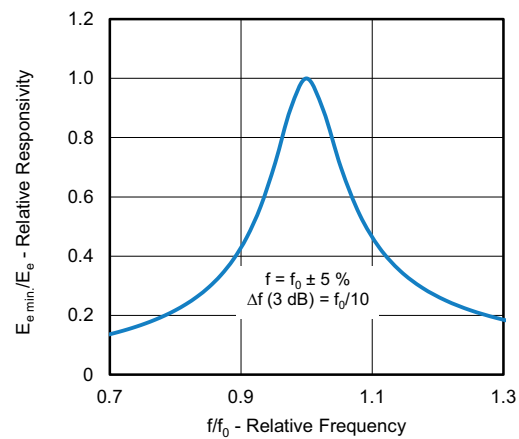

Fig. 5 - Frequency Dependence of Responsivity



Fig. 3 - Test Signal

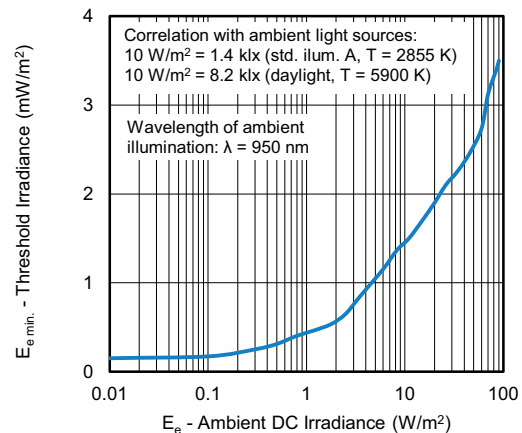

Fig. 6 - Sensitivity in Bright Ambient

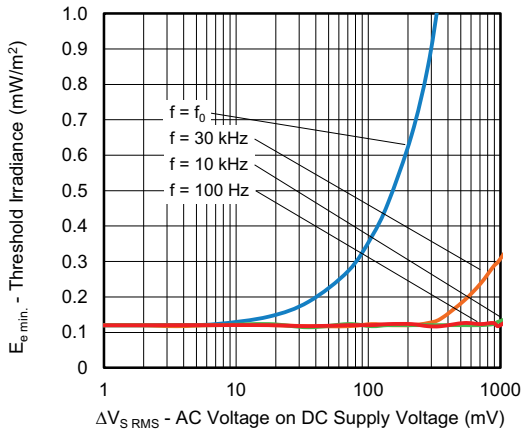

Fig. 7 - Sensitivity vs. Supply Voltage Disturbances

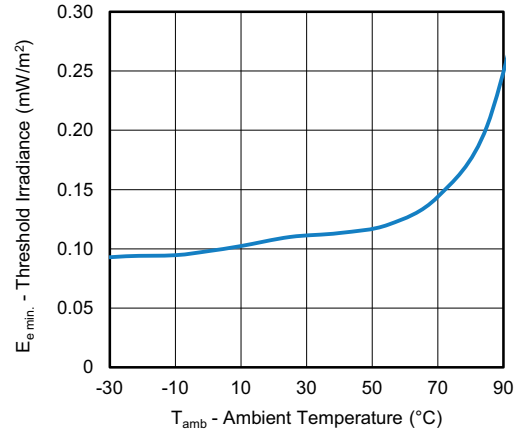

Fig. 9 - Sensitivity vs. Ambient Temperature

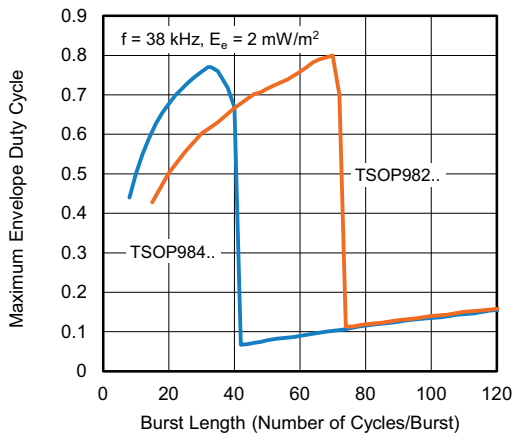

Fig. 8 - Max. Envelope Duty Cycle vs. Burst Length



Fig. 10 - Relative Spectral Sensitivity vs. Wavelength

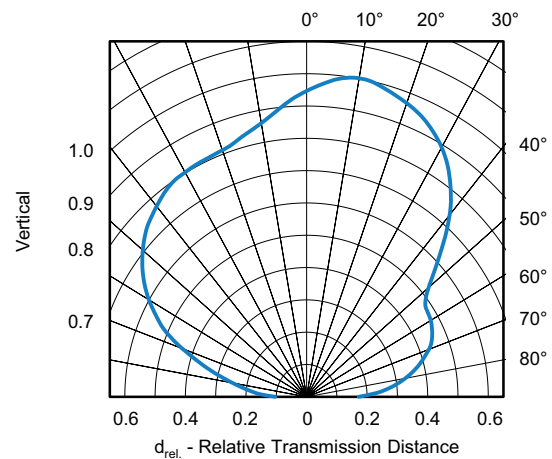

Fig. 11 - Horizontal and Vertical Directivity

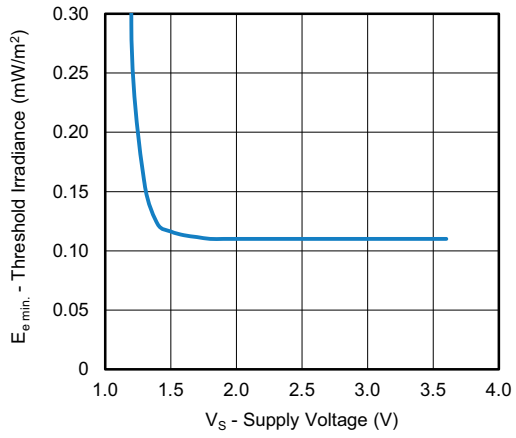

Fig. 12 - Sensitivity vs. Supply Voltage

**SUITABLE DATA FORMAT**

This series is designed to suppress spurious output pulses due to noise or disturbance signals. The devices can distinguish data signals from noise due to differences in frequency, burst length, and envelope duty cycle. The data signal should be close to the device's band-pass center frequency (e.g. 38 kHz) and fulfill the conditions in the table below.

When a data signal is applied to the product in the presence of a disturbance, the sensitivity of the receiver is automatically reduced by the AGC to insure that no spurious pulses are present at the receiver's output.

Some examples which are suppressed are:

- DC light (e.g. from tungsten bulbs sunlight)
- Continuous signals at any frequency
- Strongly or weakly modulated patterns from fluorescent lamps with electronic ballasts (see Fig. 13 or Fig. 14)



Fig. 13 - IR Disturbance from Fluorescent Lamp With Low Modulation



Fig. 14 - IR Disturbance from Fluorescent Lamp With High Modulation

	<b>TSOP982..</b>	<b>TSOP984..</b>
Minimum burst length	16 cycles/burst	10 cycles/burst
After each burst of length a minimum gap time is required of	16 to 70 cycles ≥ 16 cycles	10 to 40 cycles ≥ 12 cycles
For bursts greater than a minimum gap time in the data stream is needed of	70 cycles > 6 x burst length	40 cycles > 10 x burst length
Maximum number of continuous short bursts/second	1000	1800
RC-5 code	Yes	Yes
RC-6 code	Yes	Preferred
NEC code	Yes	Yes
r-step code 56 kHz	No	Preferred
Sony code	Preferred	No
RCA 56 kHz code	Yes	Preferred
Mitsubishi code 38 kHz	Yes	Yes
Suppression of interference from fluorescent lamps	Fig. 13	Fig. 13 and Fig. 14

**Note**

- For data formats with short bursts please see the datasheet for TSOP983.., TSOP985..



### PACKAGE DIMENSIONS in millimeters

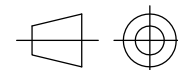
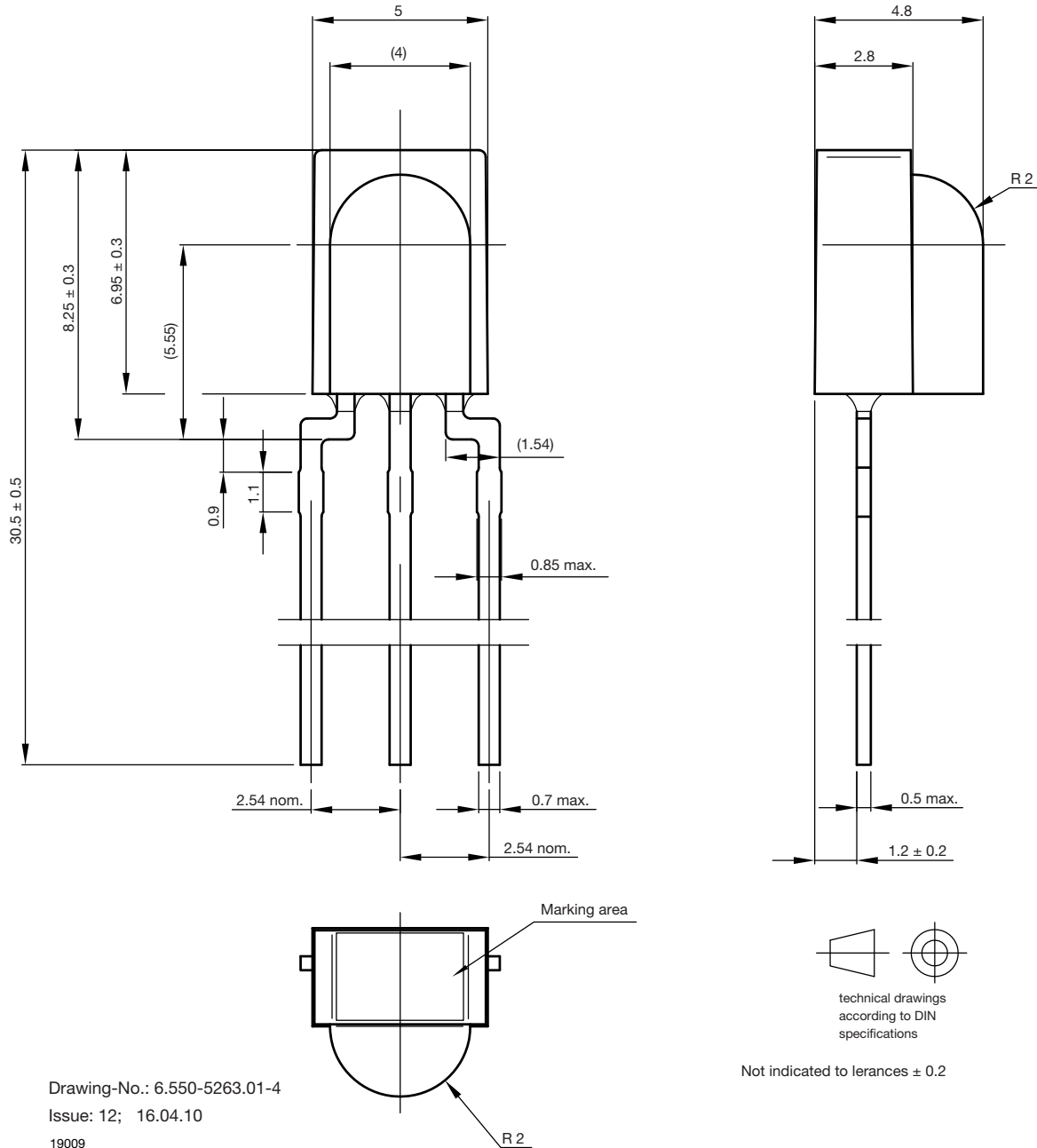

technical drawings according to DIN specifications

Not indicated to tolerances  $\pm 0.2$

Drawing-No.: 6.550-5263.01-4  
Issue: 12; 16.04.10  
19009



## Disclaimer

ALL PRODUCT, PRODUCT SPECIFICATIONS AND DATA ARE SUBJECT TO CHANGE WITHOUT NOTICE TO IMPROVE RELIABILITY, FUNCTION OR DESIGN OR OTHERWISE.

Vishay Intertechnology, Inc., its affiliates, agents, and employees, and all persons acting on its or their behalf (collectively, "Vishay"), disclaim any and all liability for any errors, inaccuracies or incompleteness contained in any datasheet or in any other disclosure relating to any product.

Vishay makes no warranty, representation or guarantee regarding the suitability of the products for any particular purpose or the continuing production of any product. To the maximum extent permitted by applicable law, Vishay disclaims (i) any and all liability arising out of the application or use of any product, (ii) any and all liability, including without limitation special, consequential or incidental damages, and (iii) any and all implied warranties, including warranties of fitness for particular purpose, non-infringement and merchantability.

Statements regarding the suitability of products for certain types of applications are based on Vishay's knowledge of typical requirements that are often placed on Vishay products in generic applications. Such statements are not binding statements about the suitability of products for a particular application. It is the customer's responsibility to validate that a particular product with the properties described in the product specification is suitable for use in a particular application. Parameters provided in datasheets and / or specifications may vary in different applications and performance may vary over time. All operating parameters, including typical parameters, must be validated for each customer application by the customer's technical experts. Product specifications do not expand or otherwise modify Vishay's terms and conditions of purchase, including but not limited to the warranty expressed therein.

Hyperlinks included in this datasheet may direct users to third-party websites. These links are provided as a convenience and for informational purposes only. Inclusion of these hyperlinks does not constitute an endorsement or an approval by Vishay of any of the products, services or opinions of the corporation, organization or individual associated with the third-party website. Vishay disclaims any and all liability and bears no responsibility for the accuracy, legality or content of the third-party website or for that of subsequent links.

Except as expressly indicated in writing, Vishay products are not designed for use in medical, life-saving, or life-sustaining applications or for any other application in which the failure of the Vishay product could result in personal injury or death. Customers using or selling Vishay products not expressly indicated for use in such applications do so at their own risk. Please contact authorized Vishay personnel to obtain written terms and conditions regarding products designed for such applications.

No license, express or implied, by estoppel or otherwise, to any intellectual property rights is granted by this document or by any conduct of Vishay. Product names and markings noted herein may be trademarks of their respective owners.