

# ON Semiconductor

## Is Now

# onsemi™

To learn more about onsemi™, please visit our website at  
[www.onsemi.com](http://www.onsemi.com)

---

**onsemi** and **onsemi** and other names, marks, and brands are registered and/or common law trademarks of Semiconductor Components Industries, LLC dba "**onsemi**" or its affiliates and/or subsidiaries in the United States and/or other countries. **onsemi** owns the rights to a number of patents, trademarks, copyrights, trade secrets, and other intellectual property. A listing of **onsemi** product/patent coverage may be accessed at [www.onsemi.com/site/pdf/Patent-Marking.pdf](http://www.onsemi.com/site/pdf/Patent-Marking.pdf). **onsemi** reserves the right to make changes at any time to any products or information herein, without notice. The information herein is provided "as-is" and **onsemi** makes no warranty, representation or guarantee regarding the accuracy of the information, product features, availability, functionality, or suitability of its products for any particular purpose, nor does **onsemi** assume any liability arising out of the application or use of any product or circuit, and specifically disclaims any and all liability, including without limitation special, consequential or incidental damages. Buyer is responsible for its products and applications using **onsemi** products, including compliance with all laws, regulations and safety requirements or standards, regardless of any support or applications information provided by **onsemi**. "Typical" parameters which may be provided in **onsemi** data sheets and/or specifications can and do vary in different applications and actual performance may vary over time. All operating parameters, including "Typicals" must be validated for each customer application by customer's technical experts. **onsemi** does not convey any license under any of its intellectual property rights nor the rights of others. **onsemi** products are not designed, intended, or authorized for use as a critical component in life support systems or any FDA Class 3 medical devices or medical devices with a same or similar classification in a foreign jurisdiction or any devices intended for implantation in the human body. Should Buyer purchase or use **onsemi** products for any such unintended or unauthorized application, Buyer shall indemnify and hold **onsemi** and its officers, employees, subsidiaries, affiliates, and distributors harmless against all claims, costs, damages, and expenses, and reasonable attorney fees arising out of, directly or indirectly, any claim of personal injury or death associated with such unintended or unauthorized use, even if such claim alleges that **onsemi** was negligent regarding the design or manufacture of the part. **onsemi** is an Equal Opportunity/Affirmative Action Employer. This literature is subject to all applicable copyright laws and is not for resale in any manner. Other names and brands may be claimed as the property of others.

# MOSFET - Power, N-Channel, Shielded Gate

## 80 V, 8.3 mΩ, 61 A



ON Semiconductor®

[www.onsemi.com](http://www.onsemi.com)

## NVTFS8D1N08H

### Features

- Small Footprint (5x6 mm) for Compact Design
- Low  $R_{DS(on)}$  to Minimize Conduction Losses
- Low  $Q_G$  and Capacitance to Minimize Driver Losses
- NVTFS8D1N08H – Wettable Flank Option for Enhanced Optical Inspection
- AEC-Q101 Qualified and PPAP Capable
- These Devices are Pb-Free, Halogen Free/BFR Free and are RoHS Compliant

### MAXIMUM RATINGS ( $T_J = 25^\circ\text{C}$ unless otherwise noted)

Parameter		Symbol	Value	Unit	
Drain-to-Source Voltage		$V_{DSS}$	80	V	
Gate-to-Source Voltage		$V_{GS}$	$\pm 20$	V	
Continuous Drain Current $R_{\theta JC}$ (Notes 1, 3)	Steady State	$I_D$	$T_C = 25^\circ\text{C}$	61	A
			$T_C = 100^\circ\text{C}$	43	
Power Dissipation $R_{\theta JC}$ (Note 1)	Steady State	$P_D$	$T_C = 25^\circ\text{C}$	75	W
			$T_C = 100^\circ\text{C}$	38	
Continuous Drain Current $R_{\theta JA}$ (Notes 1, 2, 3)	Steady State	$I_D$	$T_A = 25^\circ\text{C}$	14	A
			$T_A = 25^\circ\text{C}$	10	
Power Dissipation $R_{\theta JA}$ (Notes 1, 2)	Steady State	$P_D$	$T_A = 25^\circ\text{C}$	3.8	W
			$T_A = 25^\circ\text{C}$	1.9	
Pulsed Drain Current	$T_A = 25^\circ\text{C}, t_p = 100 \mu\text{s}$	$I_{DM}$	216	A	
Operating Junction and Storage Temperature Range		$T_J, T_{stg}$	-55 to +175	$^\circ\text{C}$	
Source Current (Body Diode)		$I_S$	61	A	
Single Pulse Drain-to-Source Avalanche Energy		$E_{AS}$	113	mJ	
Lead Temperature for Soldering Purposes (1/8" from case for 10 s)		$T_L$	260	$^\circ\text{C}$	

Stresses exceeding those listed in the Maximum Ratings table may damage the device. If any of these limits are exceeded, device functionality should not be assumed, damage may occur and reliability may be affected.

1. The entire application environment impacts the thermal resistance values shown, they are not constants and are only valid for the particular conditions noted.
2. Surface-mounted on FR4 board using a 650 mm<sup>2</sup>, 2 oz. Cu pad.
3. Maximum current for pulses as long as 1 second is higher but is dependent on pulse duration and duty cycle.

$V_{(BR)DSS}$	$R_{DS(ON) MAX}$	$I_D MAX$
80 V	8.3 mΩ @ 10 V	61 A

### N-Channel

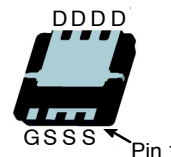
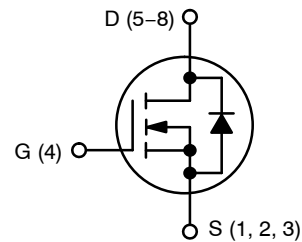

**WDFN8**  
(3.3x3.3, 0.65 P)  
CASE 511DY

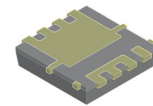

**WDFNW8**  
(3.3x3.3, 0.65 P)  
CASE 515AP

### MARKING DIAGRAMS

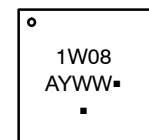
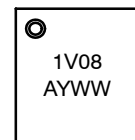

- 1V08/1W08 = Specific Device Code  
 A = Assembly Location  
 Y = Year  
 WW = Work Week  
 ■ = Pb-Free Package

(Microdot may be in either location)

### ORDERING INFORMATION

See detailed ordering, marking and shipping information on page 5 of this data sheet.

# NVTFS8D1N08H

## THERMAL RESISTANCE MAXIMUM RATINGS

Parameter	Symbol	Value	Unit
Junction-to-Case – Steady State (Note 4)	$R_{\theta JC}$	2	°C/W
Junction-to-Ambient – Steady State (Note 4)	$R_{\theta JA}$	39	

4. Surface-mounted on FR4 board using a 650 mm<sup>2</sup>, 2 oz. Cu pad.

## ELECTRICAL CHARACTERISTICS ( $T_J = 25^\circ\text{C}$ unless otherwise specified)

Parameter	Symbol	Test Condition	Min	Typ	Max	Unit
-----------	--------	----------------	-----	-----	-----	------

### OFF CHARACTERISTICS

Drain-to-Source Breakdown Voltage	$V_{(BR)DSS}$	$V_{GS} = 0\text{ V}, I_D = 250\ \mu\text{A}$	80	-	-	V	
Drain-to-Source Breakdown Voltage Temperature Coefficient	$V_{(BR)DSS}/T_J$		-	52	-	mV/°C	
Zero Gate Voltage Drain Current	$I_{DSS}$	$V_{GS} = 0\text{ V}, V_{DS} = 64\text{ V}$	$T_J = 25^\circ\text{C}$	-	-	10	$\mu\text{A}$
			$T_J = 125^\circ\text{C}$	-	-	250	
Gate-to-Source Leakage Current	$I_{GSS}$	$V_{DS} = 0\text{ V}, V_{GS} = 20\text{ V}$	-	-	100	nA	

### ON CHARACTERISTICS (Note 5)

Gate Threshold Voltage	$V_{GS(TH)}$	$V_{GS} = V_{DS}, I_D = 270\ \mu\text{A}$	2.0	2.8	4.0	V
Threshold Temperature Coefficient	$V_{GS(TH)}/T_J$		-	-7.2	-	mV/°C
Drain-to-Source On Resistance	$R_{DS(on)}$	$V_{GS} = 10\text{ V}, I_D = 16\text{ A}$	-	6.4	8.3	m $\Omega$
		$V_{GS} = 6\text{ V}, I_D = 13\text{ A}$	-	9	12.6	

### CHARGES, CAPACITANCES & GATE RESISTANCE

Input Capacitance	$C_{ISS}$	$V_{GS} = 0\text{ V}, V_{DS} = 40\text{ V}, f = 1\text{ MHz}$	-	1450	-	$\mu\text{F}$
Output Capacitance	$C_{OSS}$		-	776	-	
Reverse Transfer Capacitance	$C_{RSS}$		-	46	-	
Total Gate Charge	$Q_{G(TOT)}$	$V_{GS} = 6\text{ V}, V_{DS} = 40\text{ V}; I_D = 16\text{ A}$	-	9	-	nC
			$V_{GS} = 10\text{ V}, V_{DS} = 40\text{ V}; I_D = 16\text{ A}$	-	23	
Threshold Gate Charge	$Q_{G(TH)}$	$V_{GS} = 10\text{ V}, V_{DS} = 40\text{ V}; I_D = 16\text{ A}$	-	9	-	nC
Gate-to-Source Charge	$Q_{GS}$		-	7.2	-	
Gate-to-Drain Charge	$Q_{GD}$		-	4.2	-	
Plateau Voltage	$V_{GP}$		-	4.6	-	

### SWITCHING CHARACTERISTICS (Note 6)

Turn-On Delay Time	$t_{d(ON)}$	$V_{GS} = 10\text{ V}, V_{DS} = 40\text{ V}, I_D = 16\text{ A}, R_G = 2.5\ \Omega$	-	9.1	-	ns
Rise Time	$t_r$		-	13	-	
Turn-Off Delay Time	$t_{d(OFF)}$		-	23.8	-	
Fall Time	$t_f$		-	2.5	-	

### DRAIN-SOURCE DIODE CHARACTERISTICS

Source-to-Drain Diode Forward Voltage	$V_{SD}$	$V_{GS} = 0\text{ V}, I_S = 16\text{ A}$	-	0.81	1.2	V
Reverse Recovery Time	$t_{RR}$	$I_F = 16\text{ A}, di/dt = 100\text{ A}/\mu\text{s}$	-	40.5	-	ns
Reverse Recovery Charge	$Q_{RR}$		-	46.8	-	
Charge Time	$t_a$		-	22.6	-	ns
Discharge Time	$t_b$		-	17.9	-	ns

Product parametric performance is indicated in the Electrical Characteristics for the listed test conditions, unless otherwise noted. Product performance may not be indicated by the Electrical Characteristics if operated under different conditions.

5. Pulse Test: pulse width  $\leq 300\ \mu\text{s}$ , duty cycle  $\leq 2\%$ .

6. Switching characteristics are independent of operating junction temperatures.

# NVTFS8D1N08H

## TYPICAL CHARACTERISTICS

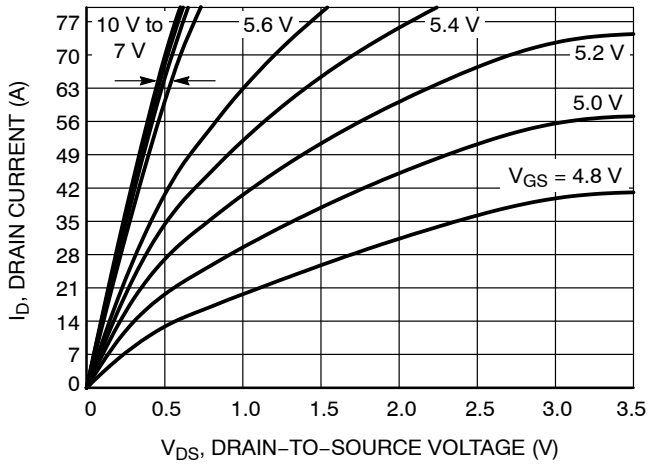

Figure 1. On-Region Characteristics

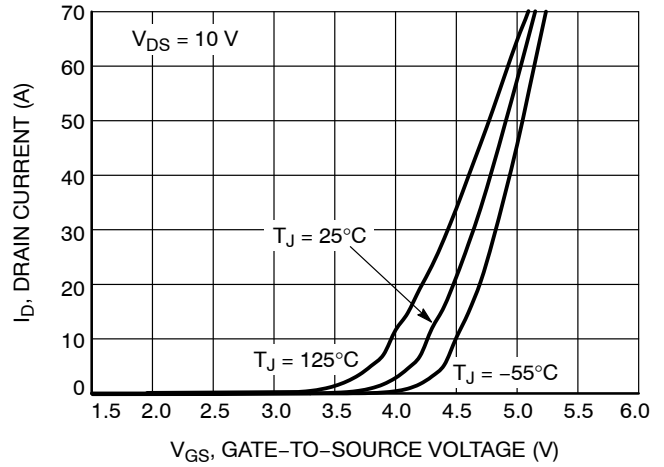

Figure 2. Transfer Characteristics

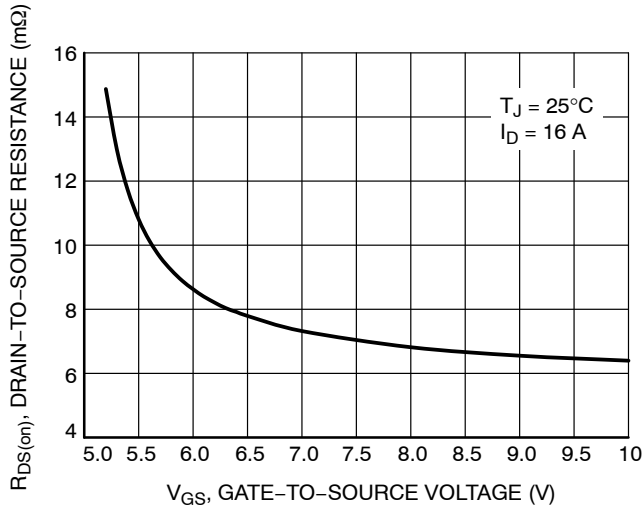

Figure 3. On-Resistance vs. Gate-to-Source Voltage

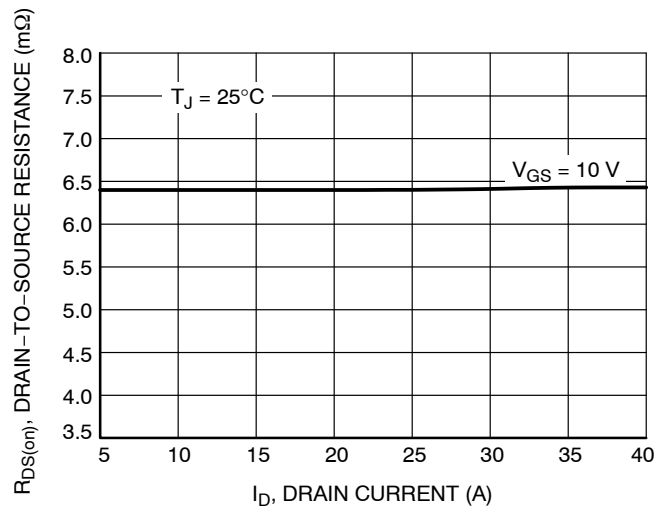

Figure 4. On-Resistance vs. Drain Current and Gate Voltage

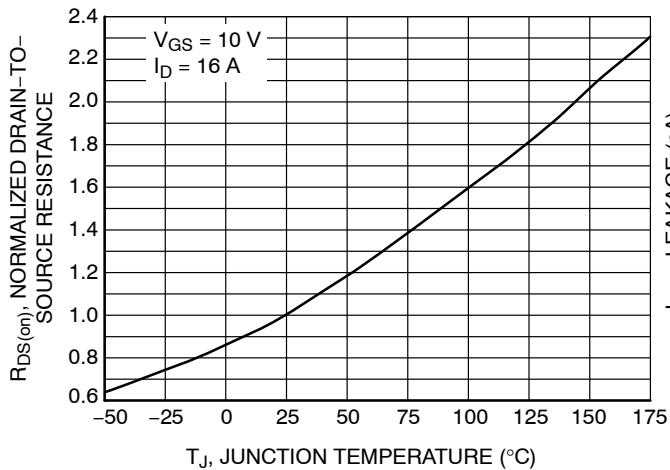

Figure 5. On-Resistance Variation with Temperature

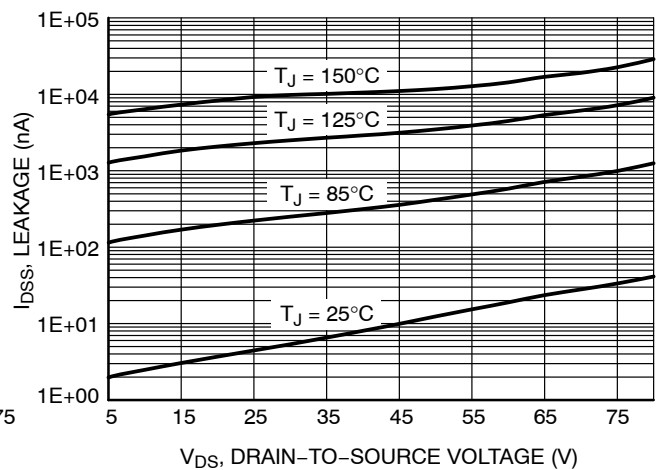
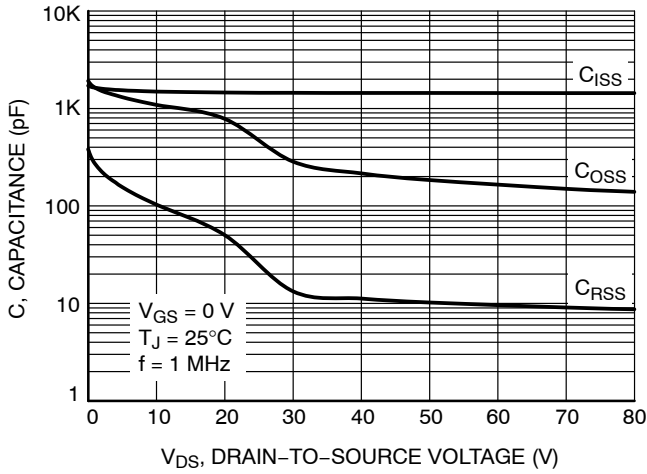

Figure 6. Drain-to-Source Leakage Current vs. Voltage

# NVTF8D1N08H

## TYPICAL CHARACTERISTICS



**Figure 7. Capacitance Variation**

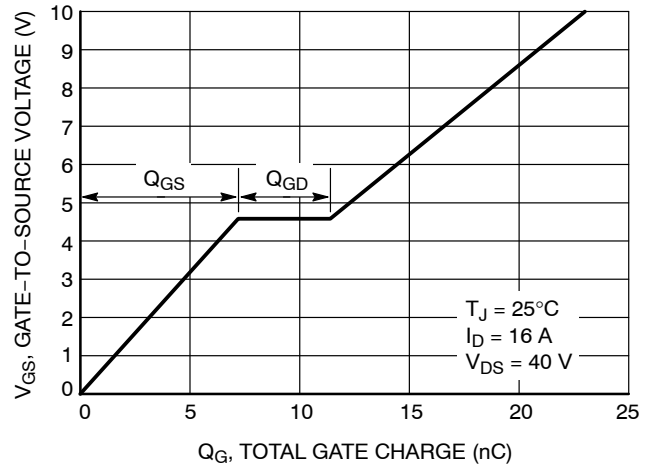

**Figure 8. Gate-to-Source Voltage vs. Total Charge**

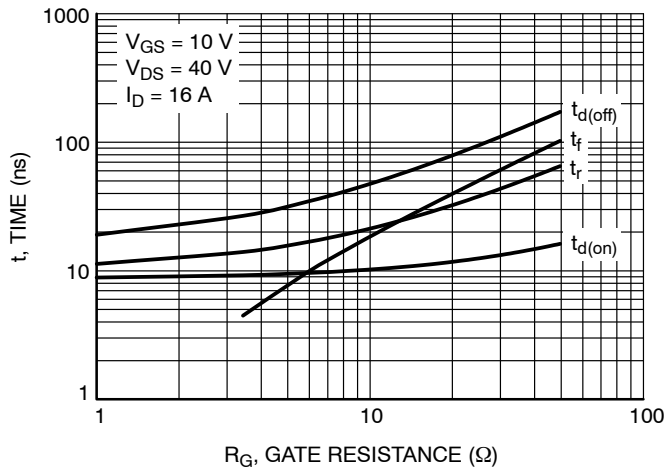

**Figure 9. Resistive Switching Time Variation vs. Gate Resistance**

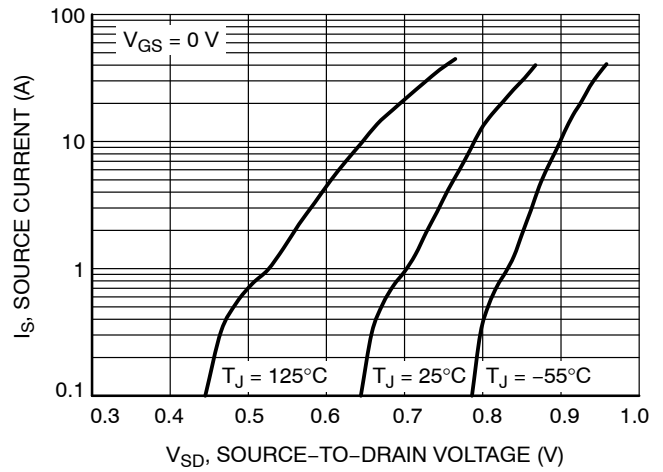

**Figure 10. Diode Forward Voltage vs. Current**

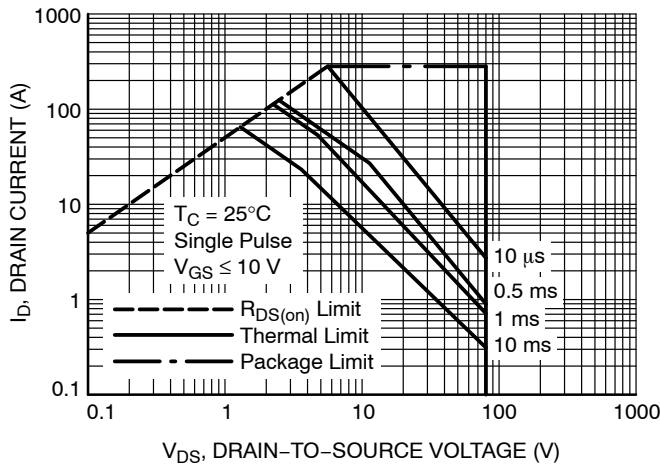

**Figure 11. Maximum Rated Forward Biased Safe Operating Area**

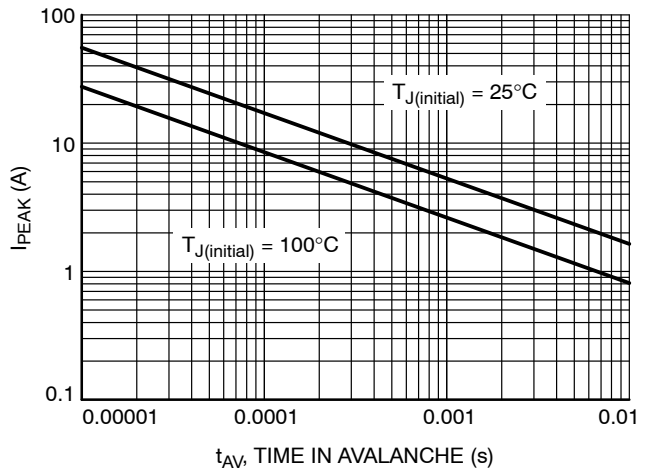

**Figure 12. Maximum Drain Current vs. Time in Avalanche**

# NVTF8D1N08H

## TYPICAL CHARACTERISTICS

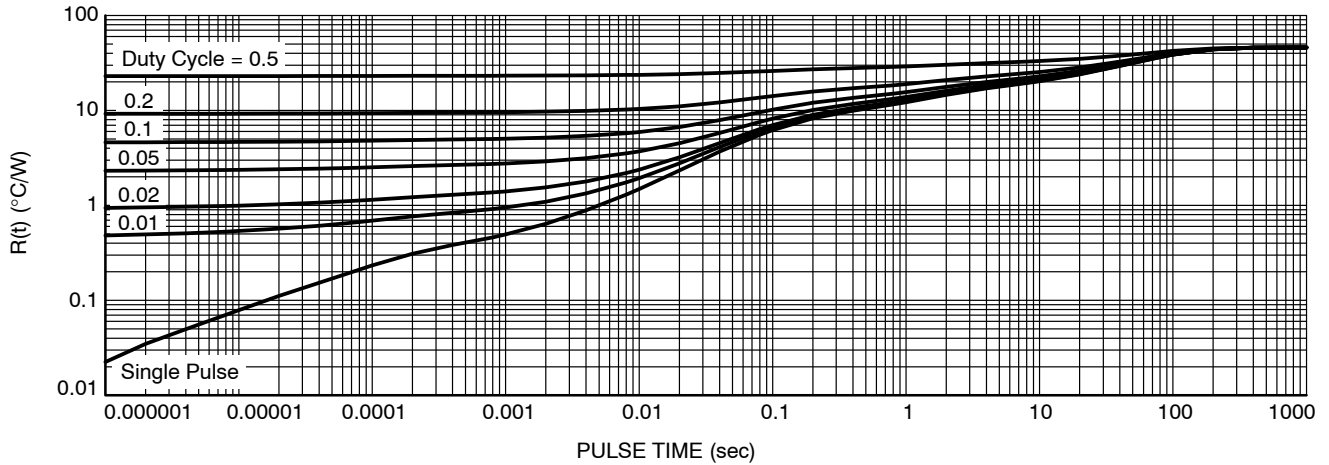

Figure 13. Transient Thermal Impedance

### DEVICE ORDERING INFORMATION

Device	Marking	Package	Shipping <sup>†</sup>
NVTF8D1N08HTAG	1V08	WDFN8 (Pb-Free)	1500 / Tape & Reel
NVTFWS8D1N08HTAG	1W08	WDFNW8 (Pb-Free, Wettable Flanks)	1500 / Tape & Reel

<sup>†</sup>For information on tape and reel specifications, including part orientation and tape sizes, please refer to our Tape and Reel Packaging Specifications Brochure, [BRD8011/D](#).

# NVTFS8D1N08H

## PACKAGE DIMENSIONS

WDFN8 3.3x3.3, 0.65P  
CASE 511DY  
ISSUE A

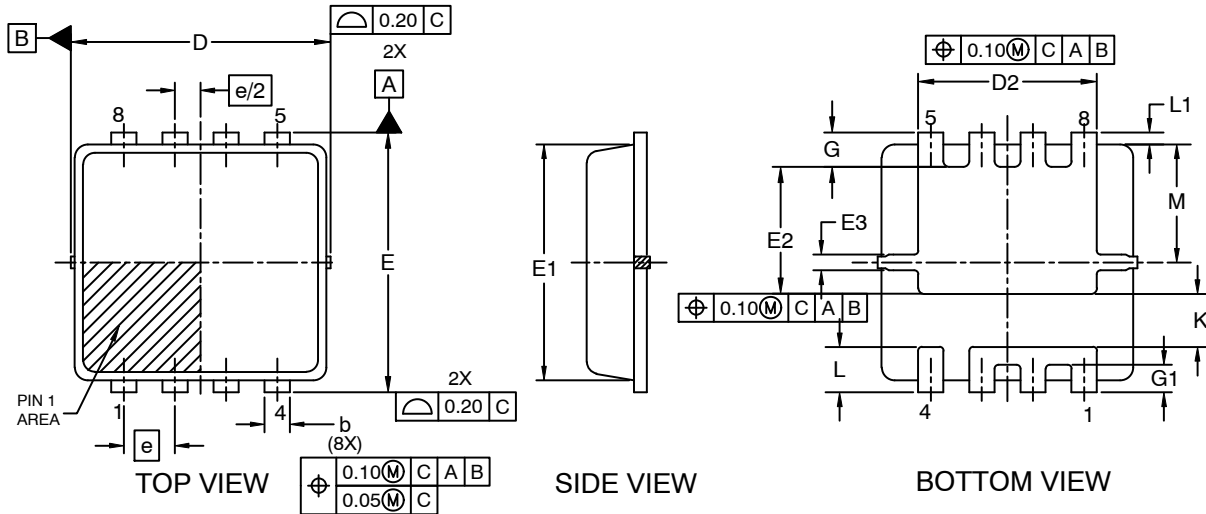

### NOTES:

1. CONTROLLING DIMENSION: MILLIMETERS
2. DIMENSIONS D1 & E1 DO NOT INCLUDE MOLD FLASH PROTRUSIONS NOR GATE BURRS.

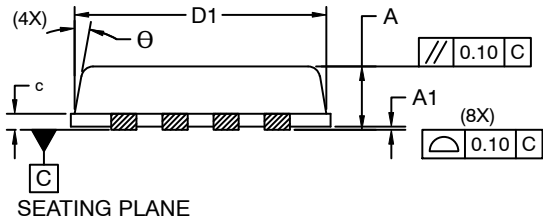

END VIEW

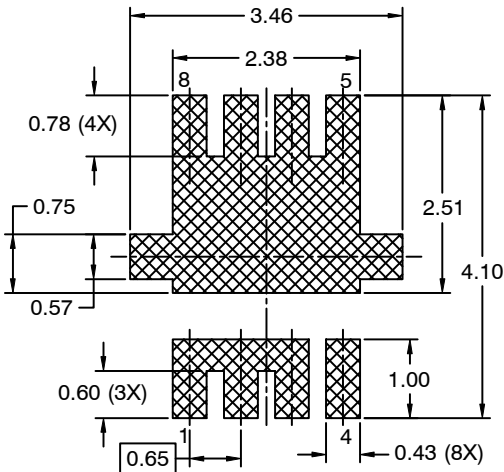

DIM	MILLIMETERS		
	MIN	NOM	MAX
A	0.70	0.75	0.80
A1	0.00	-	0.05
b	0.23	0.33	0.43
c	0.15	0.20	0.25
D	3.20	3.30	3.40
D1	2.95	3.13	3.30
D2	1.98	2.20	2.40
E	3.20	3.30	3.40
E1	2.80	3.00	3.15
E2	1.40	1.60	1.80
E3	0.15	0.25	0.40
e	0.65 BSC		
G	0.30	0.43	0.55
G1	0.25	0.35	0.45
K	0.55	0.75	0.95
L	0.35	0.52	0.65
L1	0.06	0.15	0.30
M	1.35	1.50	1.60
$\theta$	0	-	12

# NVTFS8D1N08H

## PACKAGE DIMENSIONS

WDFNW8 3.3x3.3, 0.65P (Full-Cut  $\mu$ 8FL Fused WF)  
CASE 515AP  
ISSUE O

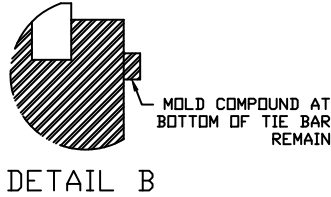
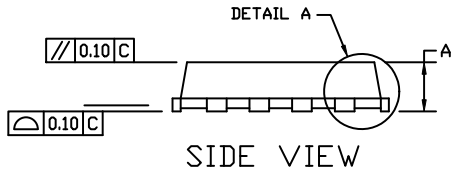
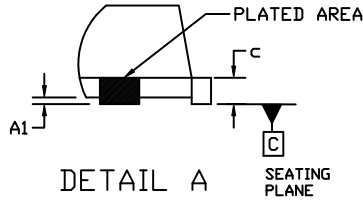
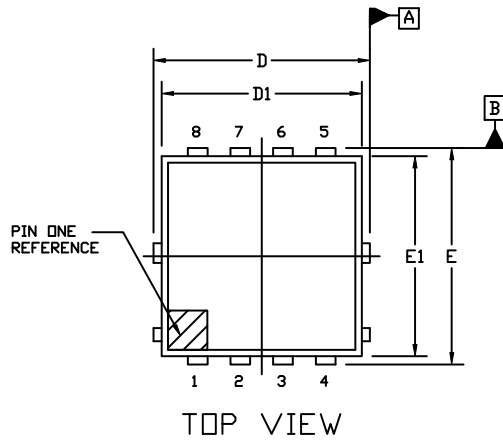

NOTES:

1. DIMENSIONING AND TOLERANCING PER ASME Y14.5M, 2009.
2. CONTROLLING DIMENSION: MILLIMETERS
3. DIMENSION D1 AND E1 DO NOT INCLUDE MOLD FLASH, PROTRUSIONS, OR GATE BURRS.

DIM	MILLIMETERS		
	MIN.	NOM.	MAX.
A	0.70	0.75	0.80
A1	0.00	----	0.05
b	0.23	0.33	0.43
c	0.15	0.20	0.25
D	3.20	3.30	3.40
D1	2.95	3.13	3.30
D2	1.98	2.20	2.40
E	3.20	3.30	3.40
E1	2.80	3.00	3.15
E2	1.40	1.60	1.80
E3	0.15	0.25	0.40
e	0.65 BSC		
G	0.30	0.43	0.55
G1	0.25	0.35	0.45
K	0.55	0.75	0.95
L	0.35	0.52	0.65
L1	0.06	0.15	0.30
M	1.35	1.50	1.60

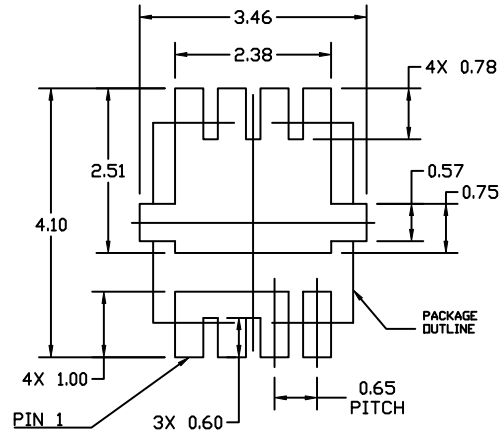
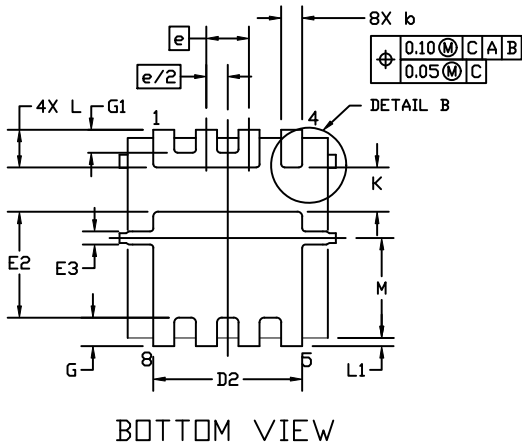

\* For additional information on our Pb-Free strategy and soldering details, please download the IN Semiconductor Soldering and Mounting Techniques Reference Manual, SOLDERRM/D.



ON Semiconductor and  are trademarks of Semiconductor Components Industries, LLC dba ON Semiconductor or its subsidiaries in the United States and/or other countries. ON Semiconductor owns the rights to a number of patents, trademarks, copyrights, trade secrets, and other intellectual property. A listing of ON Semiconductor's product/patent coverage may be accessed at [www.onsemi.com/site/pdf/Patent-Marking.pdf](http://www.onsemi.com/site/pdf/Patent-Marking.pdf). ON Semiconductor reserves the right to make changes without further notice to any products herein. ON Semiconductor makes no warranty, representation or guarantee regarding the suitability of its products for any particular purpose, nor does ON Semiconductor assume any liability arising out of the application or use of any product or circuit, and specifically disclaims any and all liability, including without limitation special, consequential or incidental damages. Buyer is responsible for its products and applications using ON Semiconductor products, including compliance with all laws, regulations and safety requirements or standards, regardless of any support or applications information provided by ON Semiconductor. "Typical" parameters which may be provided in ON Semiconductor data sheets and/or specifications can and do vary in different applications and actual performance may vary over time. All operating parameters, including "Typicals" must be validated for each customer application by customer's technical experts. ON Semiconductor does not convey any license under its patent rights nor the rights of others. ON Semiconductor products are not designed, intended, or authorized for use as a critical component in life support systems or any FDA Class 3 medical devices or medical devices with a same or similar classification in a foreign jurisdiction or any devices intended for implantation in the human body. Should Buyer purchase or use ON Semiconductor products for any such unintended or unauthorized application, Buyer shall indemnify and hold ON Semiconductor and its officers, employees, subsidiaries, affiliates, and distributors harmless against all claims, costs, damages, and expenses, and reasonable attorney fees arising out of, directly or indirectly, any claim of personal injury or death associated with such unintended or unauthorized use, even if such claim alleges that ON Semiconductor was negligent regarding the design or manufacture of the part. ON Semiconductor is an Equal Opportunity/Affirmative Action Employer. This literature is subject to all applicable copyright laws and is not for resale in any manner.

## PUBLICATION ORDERING INFORMATION

### LITERATURE FULFILLMENT:

Email Requests to: [orderlit@onsemi.com](mailto:orderlit@onsemi.com)

ON Semiconductor Website: [www.onsemi.com](http://www.onsemi.com)

### TECHNICAL SUPPORT

North American Technical Support:  
Voice Mail: 1 800-282-9855 Toll Free USA/Canada  
Phone: 011 421 33 790 2910

Europe, Middle East and Africa Technical Support:

Phone: 00421 33 790 2910

For additional information, please contact your local Sales Representative