

NCP5208

DDR-I/II Termination Regulator

The NCP5208 is a linear regulator specifically designed for the active termination of DDR-I/II SDRAM. The device can be operated from a single supply voltage as low as 1.7 V. For DDR-I applications, the device is capable of sourcing and sinking current up to 1.5 A with the output voltage regulated to within $\pm 3\%$ or better. A separate voltage feedback pin ensures superior load regulation against load and line changes.

Protective features include soft-start, source/sink current limits and thermal shutdown. Open-drain VTT OK output (POK) is added for system monitoring. The shutdown pin can tri-state the regulator output for Suspend To RAM (STR) state. This device is available in a SOIC-8 package.

Features

- Supports Both DDR-I and DDR-II SDRAM Requirements
- Single Supply Voltage Operation as Low as 1.7 V
- Integrated Power MOSFETs
- Few External Components Needed
- Source and Sink Current Up to 1.5 A
- Load Regulation Within $\pm 3\%$
- Both Source and Sink Current Limits
- Open-Drain VTT OK (POK) Pin
- Shutdown Pin
- Thermal Shutdown
- Housed in SOIC-8 Package
- Pb-Free Package is Available

Typical Applications

- DDR Termination Voltage
- Active Bus Termination (SSTL-2, SSTL-3)

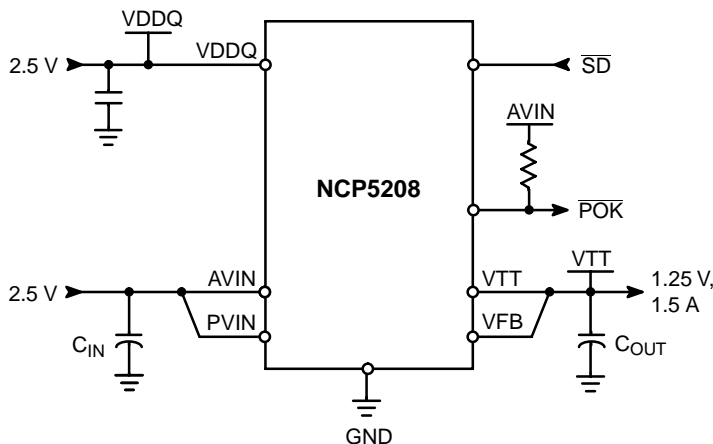

Figure 1. Typical Application Circuit



ON Semiconductor®

<http://onsemi.com>



SOIC-8
D SUFFIX
CASE 751

MARKING DIAGRAM

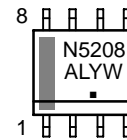

A = Assembly Location
L = Wafer Lot
Y = Year
W = Work Week
▪ = Pb-Free Package

PIN CONNECTIONS

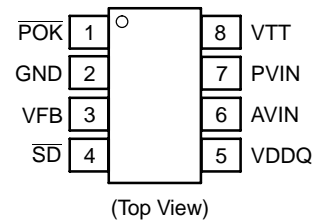

ORDERING INFORMATION

Device	Package	Shipping†
NCP5208DR2	SOIC-8	2500/Tape & Reel
NCP5208DR2G	SOIC-8 (Pb-Free)	2500/Tape & Reel

† For information on tape and reel specifications, including part orientation and tape sizes, please refer to our Tape and Reel Packaging Specifications Brochure, BRD8011/D.

NCP5208

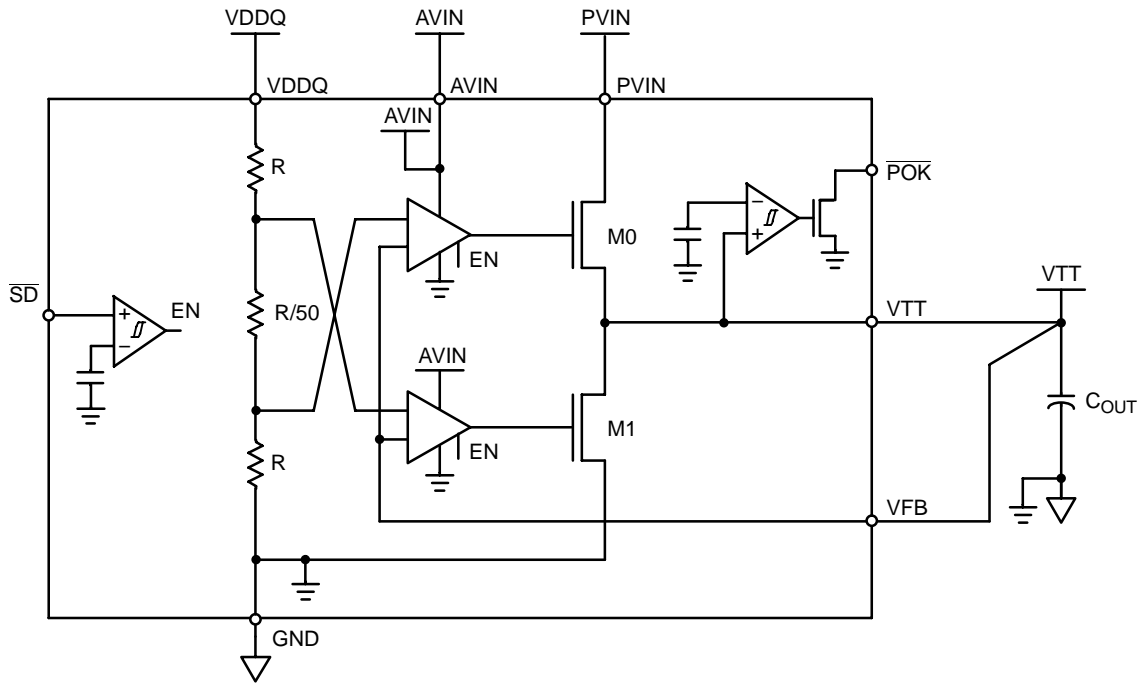

Figure 2. Simplified Functional Block Diagram

PIN FUNCTION DESCRIPTION

Pin	Symbol	Description
1	$\overline{\text{POK}}$	Open-drain VTT Power OK output
2	GND	Ground
3	VFB	Remote sensing Feedback pin for regulating VTT
4	$\overline{\text{SD}}$	Active low shutdown pin to tri-state VTT output, this pin is pulled high internally
5	VDDQ	Reference input for VTT regulator
6	AVIN	Analog supply input, this powers all the internal control circuitry
7	PVIN	Power supply input, this provides the rail voltage for the VTT output
8	VTT	Termination Regulator output

MAXIMUM RATINGS

Rating	Symbol	Value	Unit
AVIN, PVIN, VDDQ, VFB, VTT to GND	-	-0.3, 6.0	V
Input/Output Pins	$\overline{\text{SD}}$	V_{IO}	-0.3, 6.0 V
Open Drain Output Pins	$\overline{\text{POK}}$	V_{POK}	-0.3, 6.0 V
Thermal Characteristics SOIC-8 Package – Thermal Resistance, Junction-to-Air	$R_{\theta\text{JA_T}}$	151	°C/W
Operating Junction Temperature Range	T_{J}	-10 to +150	°C
Operating Ambient Temperature Range	T_{A}	0 to +70	°C
Storage Temperature Range	T_{stg}	-55 to +150	°C

Stresses exceeding Maximum Ratings may damage the device. Maximum Ratings are stress ratings only. Functional operation above the Recommended Operating Conditions is not implied. Extended exposure to stresses above the Recommended Operating Conditions may affect device reliability.

- This device series contains ESD protection and exceeds the following tests:
Human Body Model (HBM) ≤ 2.0 kV per JEDEC standard: JESD22-A114.
Machine Model (MM) ≤ 200 V per JEDEC standard: JESD22-A115.
- Latchup Current Maximum Rating: ± 150 mA per JEDEC standard: JESD78.

NCP5208

ELECTRICAL CHARACTERISTICS (AVIN = 2.5 V, PVIN = 2.5 V, VDDQ = 2.5 V, C_{OUT} = 220 μF, for typical values T_A = 25°C, for min/max values T_A = 0 to 70°C, unless otherwise noted.)

Characteristic	Conditions	Symbol	Min	Typ	Max	Unit
Analog Supply Input	–	AVIN	1.7	–	5.5	V
Power Supply Input	–	PVIN	1.7	–	AVIN	V
Termination Voltage Output	AVIN = 2.5 V, VDDQ = PVIN = 1.8 V IVTT = –0.6 A to +0.6 A	VTT	0.870	0.900	0.930	V
	AVIN = PVIN = VDDQ = 2.5 V IVTT = –1.5 A to 1.5 A		1.215	1.250	1.285	V
Load Regulation	VDDQ = 1.8 V, IVTT = 0 to +0.6 A VDDQ = 1.8 V, IVTT = 0 to –0.6 A	ΔVTT	–	–	15	mV
	VDDQ = 2.5 V, IVTT = 0 to +1.5 A VDDQ = 2.5 V, IVTT = 0 to –1.5 A		–18	–	–	mV
Analog Current Consumption	No Load	IAVIN	–	–	10	mA
VDDQ Input Impedance	–	ZVDDQ	–	50	–	kΩ
VFB Feedback Pin Input Current	(Note 3)	IVFB	–	–	20	nA

SHUTDOWN CONTROL

Shutdown Pin Enable Threshold	–	VSD	1.14	1.24	1.34	V
Shutdown Pin Hysteresis	–	VSDhys	0.40	0.55	0.68	V
Shutdown Pin Input Current	VDDQ = 2.5 V, VSD = 0 V	ISD	–15	–	–	μA
	VDDQ = 2.5 V, VSD = 2.5 V		–	–	10	
	VDDQ = 2.5 V, VSD = 5.5 V		–	–	12	
Shutdown Analog Supply Current	VDDQ = 2.5 V, VSD = 0 V	Ishut	–	–	15	μA

VTT POWER OK INDICATOR

VTT Power OK Window Low Threshold	(Note 4)	POKLth	–	VDDQ × (1/2–0.02)	–	V
VTT Power OK Window High Threshold	(Note 4)	POKHth	–	VDDQ × (1/2+ 0.02)	–	V
POK Pull–LOW Resistance	IPOK = 5.0 mA	RPOKL	7.0	–	20	Ω
POK Leakage Current	VDDQ = 2.5 V, VPOK = 6.0 V	IPOKleak	–	–	0.1	μA

OVER CURRENT PROTECTION

Source Current Limit	–	ILIMsrc	1.65	2.1	2.9	A
Sink Current Limit	–	ILIMsnk	–2.9	–2.0	–1.65	A

OVER TEMPERATURE PROTECTION

Thermal Shutdown Temperature	(Note 3)	TSD	120	135	150	°C
Thermal Shutdown Hysteresis	(Note 3)	TSDhys	–	30	–	°C

3. Values are not tested in production, guaranteed by design only.

4. Production test performed for AVIN = PVIN = VDDQ = 2.5 V only, 1.8 V performance guaranteed by design.

TYPICAL OPERATING CHARACTERISTICS

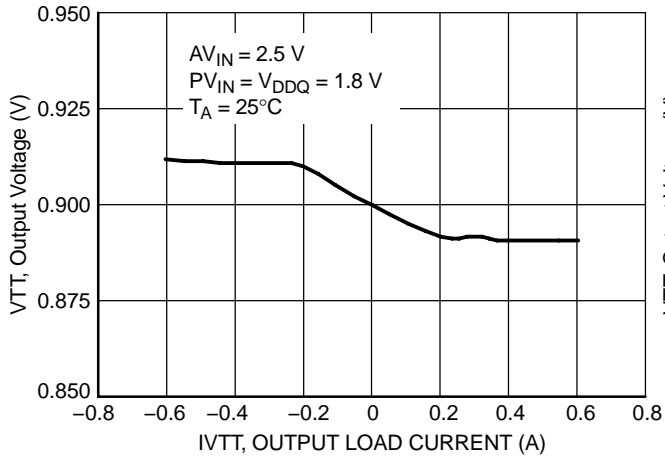

Figure 3. VTT Output Voltage vs. Load Current ($V_{DDQ} = 1.8\text{ V}$)

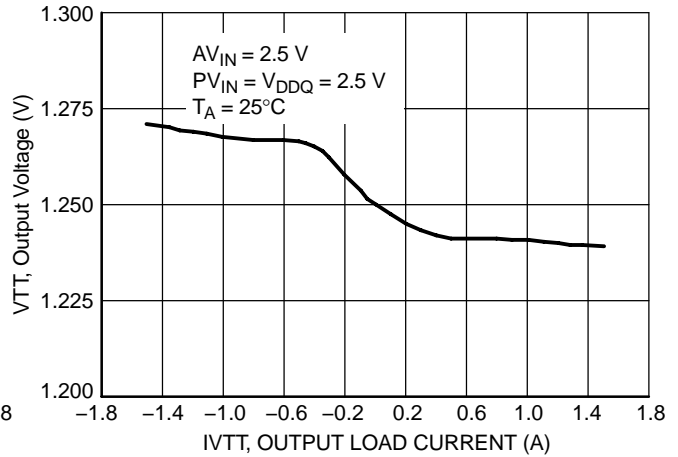

Figure 4. VTT Output Voltage vs. Load Current ($V_{DDQ} = 2.5\text{ V}$)

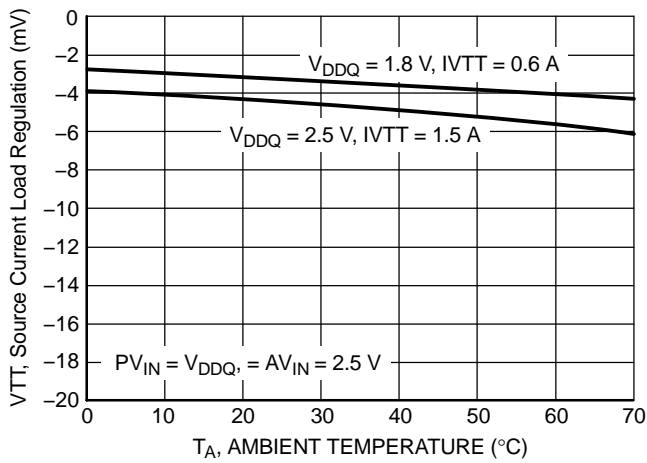

Figure 5. Source Current Load Regulation vs. Ambient Temperature

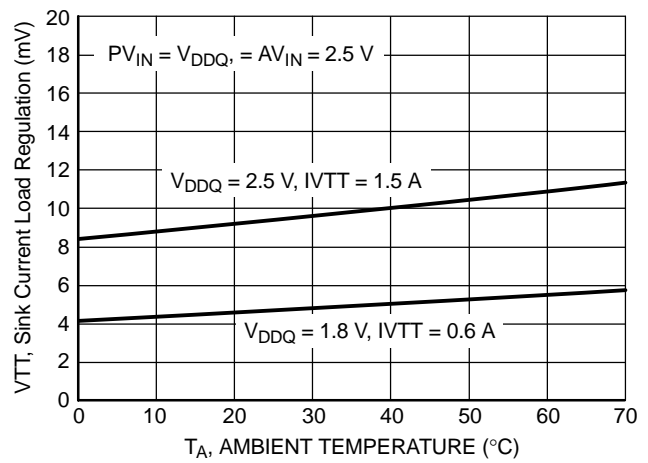

Figure 6. Sink Current Load Regulation vs. Ambient Temperature

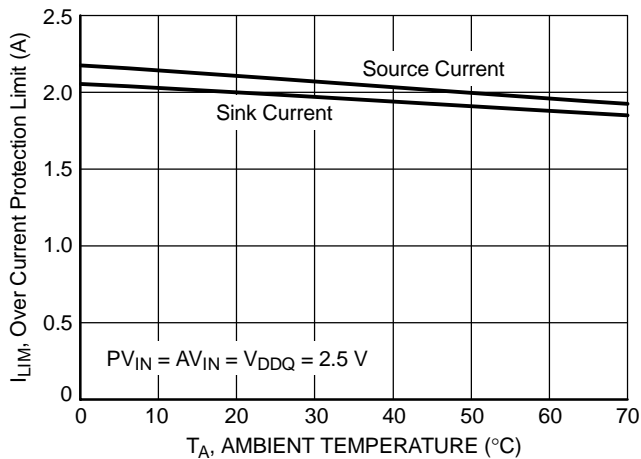

Figure 7. Over Current Protection Limit vs. Ambient Temperature

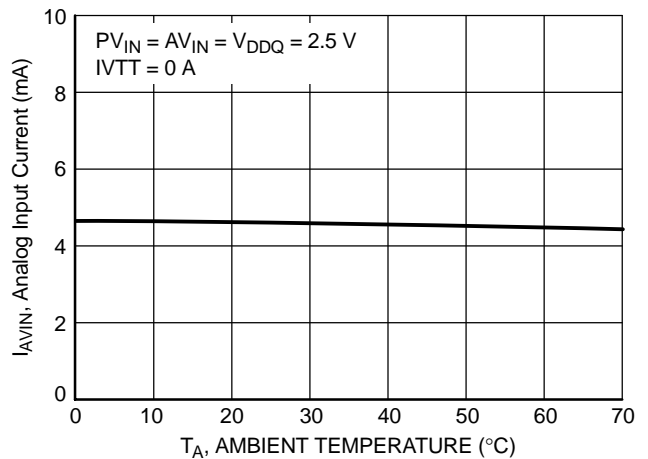

Figure 8. Analog Input Current vs. Ambient Temperature

TYPICAL OPERATING CHARACTERISTICS

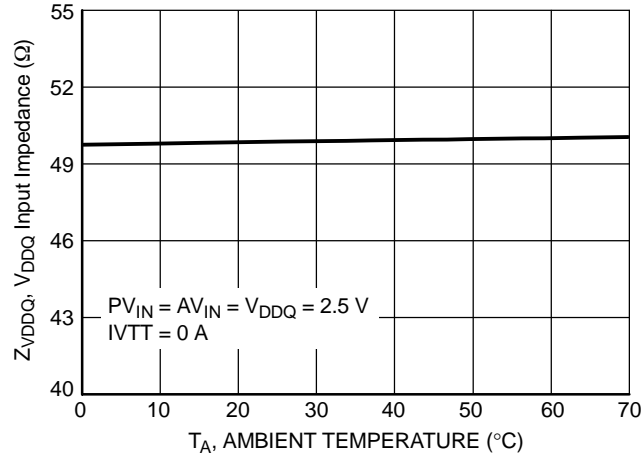
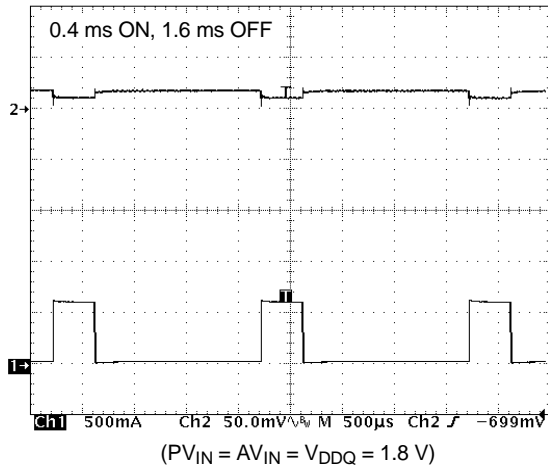

Figure 9. V_{DDQ} Input Impedance vs. Ambient Temperature

TYPICAL OPERATING WAVEFORMS



Upper Trace: VTT Output Waveform, 50 mV/Division, AC Coupled
Lower Trace: Loading Current, IVTT, 500 mA/Division

Figure 10. VTT Current Source Transient

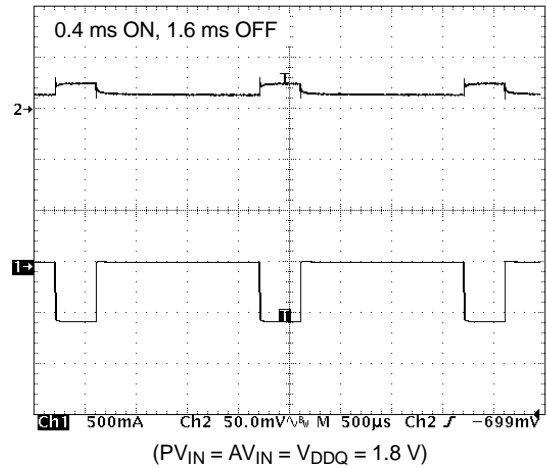

Upper Trace: VTT Output Waveform, 50 mV/Division, AC Coupled
Lower Trace: Loading Current, IVTT, 500 mA/Division

Figure 11. VTT Current Sink Transient

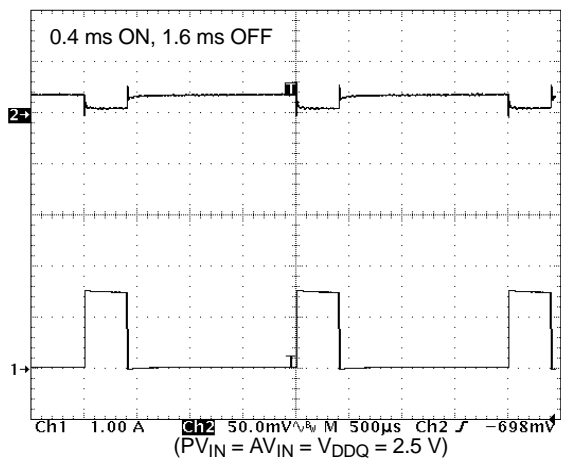

Upper Trace: VTT Output Waveform, 50 mV/Division, AC Coupled
Lower Trace: Loading Current, IVTT, 1 A/Division

Figure 12. VTT Current Source Transient

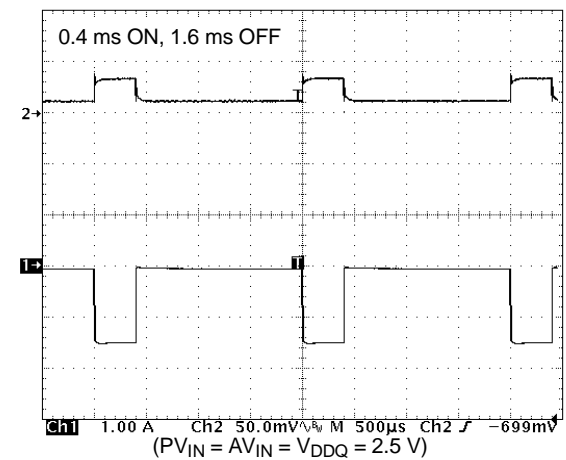

Upper Trace: VTT Output Waveform, 50 mV/Division, AC Coupled
Lower Trace: Loading Current, IVTT, 1 A/Division

Figure 13. VTT Current Sink Transient

NCP5208

TYPICAL OPERATING WAVEFORMS

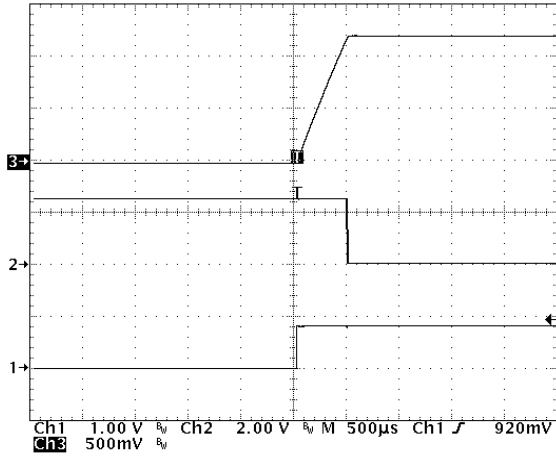

($PV_{IN} = AV_{IN} = V_{DDQ} = 2.5\text{ V}$, $IV_{TT} = 0\text{ A}$)

Upper Trace: VTT Output Waveform, 500 mV/Division

Middle Trace: VTT Power OK Output, 2 V/Division

Lower Trace: Shut-down Signal, 1 V/Division

Time Scale: 500 μs /Division

Figure 14. VTT Startup Waveform ($V_{DDQ} = 2.5\text{ V}$)

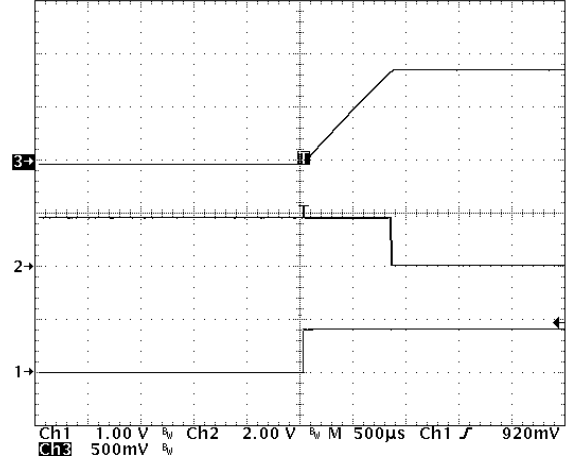

($PV_{IN} = AV_{IN} = V_{DDQ} = 1.8\text{ V}$, $IV_{TT} = 0\text{ A}$)

Upper Trace: VTT Output Waveform, 500 mV/Division

Middle Trace: VTT Power OK Output, 2 V/Division

Lower Trace: Shut-down Signal, 1 V/Division

Time Scale: 500 μs /Division

Figure 15. VTT Startup Waveform ($V_{DDQ} = 1.8\text{ V}$)

DETAILED OPERATING DESCRIPTIONS

General

The NCP5208 is a linear regulator with both sink and source current capabilities used for active termination of fast switching logic, DDR-I/II SDRAM terminations and active buses termination of SSTL-2/3 logic. This device can be operated from a single supply voltage as low as 1.7 V. For DDR-I applications, the device is capable of sourcing and sinking current up to 1.5 A with output voltage regulated to within $\pm 3\%$. The separate voltage remote feedback pin ensures superior load and line regulation with fast tracking capability.

Protective features include Soft-Start, Source/Sink Current Limits and internal Thermal Shutdown. Additionally, an open-drain VTT OK output signal ($\overline{\text{POK}}$) is provided for system monitoring. The shutdown pin ($\overline{\text{SD}}$) can be used to tri-state the regulator output for Suspend To RAM (STR) state. This device is available in a low profile, space saving SOIC-8 package.

Supply Voltage Inputs

For added flexibility, separate input pins are provided for each required supply input. AVIN is the device operating voltage, VDDQ is used to generate the internal reference for VTT output voltage control and PVIN is the power rail for the linear regulator. The device will regulate the output voltage, VTT, with respect to the internal voltage reference generated from VDDQ input and track the VDDQ changes closely. The separate PVIN pin allows the designer to isolate the high current PVIN line changes from coupling into the noise sensitive AVIN and VDDQ inputs. Since the AVIN supplies the control to the output power MOSFETs, PVIN should always be lower than or equal to AVIN.

Generation of Internal Reference Voltage

The prime function of a termination regulator is to provide a termination voltage, VTT at its output, which can track the mid-point of the logic voltage level closely, i.e. $\frac{1}{2}(\text{VDDQ})$. The VTT voltage is used to terminate the bus resistors. The NCP5208 generates a precise reference voltage internally with a built in dead-band to avoid upper and lower MOSFET shoot through.

Remote Voltage Feedback Sensing

The NCP5208 has a separate feedback pin to monitor the output voltage at the remote point. With this capability, the output voltage can be controlled precisely at the output capacitor so that any noise and fluctuations along the power path can be eliminated.

Termination Voltage Output Regulation

The NCP5208 includes a simple linear series regulator with a pair of control error amplifiers, which takes care of the current source and sink operations separately. The error amplifiers control a pair of MOSFETs to maintain the output voltage equal to the internal reference voltage for both current sink and source conditions. In order to avoid the MOSFETs turning on at the same time, a dead-band is implemented internally for safe operation.

Regulator Shutdown Function

The operation of the NCP5208 can be suspended by pulling the Shutdown ($\overline{\text{SD}}$) pin to ground. When the device is stopped, the regulator output will be tri-stated for Suspend To RAM (STR) state in PC applications. The shutdown pin is internally pulled high by a small current source, if this feature is not used, this pin can be left open.

VTT Power OK for System Monitoring

NCP5208 provides an additional VTT power OK signal for system monitoring. The VTT Power OK ($\overline{\text{POK}}$) pin goes low when the VTT voltage is in regulation and has settled within the allowed window. For memory termination applications, the system can check this pin to ensure the termination voltage quality before accessing the memory. The $\overline{\text{POK}}$ output is connected to an open-drain switching FET and the designer is free to pull this pin to any logic voltage level externally. When the VTT output is in regulation, the internal FET is turned on and pulls the power OK pin to ground.

Over-current Protection for Sink and Source Operation

In order to provide protection for the internal power MOSFETs, bi-directional current limit protection circuits are implemented. Current limit levels are internally set at 2.1 A typical for current source and 2.0 A typical for current sink at 2.5 V operation.

Thermal Shutdown with Hysteresis

To guarantee safe operation, NCP5208 provides on-chip thermal shutdown protection. When the chip junction temperature exceeds 135°C typical, the part will shutdown. When the junction temperature falls back to 105°C typical, the device resumes normal operation.

APPLICATIONS INFORMATION

Typical Application Circuit

The NCP5208 is a highly integrated termination regulator. For most applications, an input and output capacitor and a pullup resistor for the power OK output, are the only external components needed. For typical application circuit, refer to Figure 1.

AVIN and VDDQ Supply

AVIN provides power for the device to operate. This voltage must be kept clean and free from transients. A small capacitor, 1.0 μF is recommended at this input to provide the required supply filtering and ripple rejection. VDDQ is primarily used to generate the internal voltage reference, so any noise or transient at this pin will be directly reflected at the VTT output. In order to avoid undesired interference injected into this pin, appropriate de-coupling and careful design of PCB layout is required.

Input Capacitor Selection

The NCP5208 does not require an input capacitor for stability, however it is still recommended for better overall performance during large load transients that can cause sudden drop of the power rail voltage. The input capacitor must be located as close as possible to the PVIN pin to avoid a transient voltage dip affecting the quality of AVIN and VDDQ. For typical DDR-I applications, a low ESR electrolytic capacitor of 100 μF or larger is recommended. By adding a small ceramic capacitor of 0.1 μF in parallel, the best high frequency transient filtering will result. If the device is located near the main supply bulk capacitors, the input capacitance can be reduced accordingly.

Output Capacitor Selection

The NCP5208 is internally compensated and stable for any output capacitor with capacitance greater than 220 μF and with ESR ranging from 2 m Ω to 400 m Ω . The choice for this output capacitor is determined solely by the application and the requirements for load transient characteristic of VTT output. As a general recommendation, the capacitance should be larger than 220 μF with low ESR for SSTL and DDR memory applications.

Thermal Dissipation

The NCP5208 is a linear regulator, any current flow from/to VTT will result in internal power dissipation and generating heat. In order to prevent un-wanted shutdown of the device during operation, care should be taken to de-rate the power capability according to the maximum expected ambient temperature and power dissipation. The maximum allowable internal temperature rise, T_{R-MAX} can be calculated from the equation in below:

$$T_{R-MAX} = T_{J-MAX} - T_{A-MAX}$$

Where T_{J-MAX} is the maximum allowable junction temperature and T_{A-MAX} is the maximum expected ambient temperature.

The maximum allowable power dissipation for a specific condition is given by:

$$P_{D-MAX} = \frac{T_{R-MAX}}{R_{\theta JA_T}}$$

Where P_{D-MAX} is the maximum allowable power dissipation and $R_{\theta JA_T}$ is Junction-to-Air thermal resistance for specific package.

The thermal handling capability depends on several variables. Increasing the thickness and area of the copper and adding vias and airflow can improve the thermal performance.

MECHANICAL CASE OUTLINE PACKAGE DIMENSIONS



SCALE 1:1

SOIC-8 NB
CASE 751-07
ISSUE AK

DATE 16 FEB 2011



- NOTES:
1. DIMENSIONING AND TOLERANCING PER ANSI Y14.5M, 1982.
 2. CONTROLLING DIMENSION: MILLIMETER.
 3. DIMENSION A AND B DO NOT INCLUDE MOLD PROTRUSION.
 4. MAXIMUM MOLD PROTRUSION 0.15 (0.006) PER SIDE.
 5. DIMENSION D DOES NOT INCLUDE DAMBAR PROTRUSION. ALLOWABLE DAMBAR PROTRUSION SHALL BE 0.127 (0.005) TOTAL IN EXCESS OF THE D DIMENSION AT MAXIMUM MATERIAL CONDITION.
 6. 751-01 THRU 751-06 ARE OBSOLETE. NEW STANDARD IS 751-07.

DIM	MILLIMETERS		INCHES	
	MIN	MAX	MIN	MAX
A	4.80	5.00	0.189	0.197
B	3.80	4.00	0.150	0.157
C	1.35	1.75	0.053	0.069
D	0.33	0.51	0.013	0.020
G	1.27 BSC		0.050 BSC	
H	0.10	0.25	0.004	0.010
J	0.19	0.25	0.007	0.010
K	0.40	1.27	0.016	0.050
M	0°	8°	0°	8°
N	0.25	0.50	0.010	0.020
S	5.80	6.20	0.228	0.244

GENERIC MARKING DIAGRAM*

SOLDERING FOOTPRINT*



XXXXXX = Specific Device Code
A = Assembly Location
L = Wafer Lot
Y = Year
W = Work Week
▪ = Pb-Free Package

XXXXXX = Specific Device Code
A = Assembly Location
Y = Year
WW = Work Week
▪ = Pb-Free Package

*This information is generic. Please refer to device data sheet for actual part marking. Pb-Free indicator, "G" or microdot "▪", may or may not be present. Some products may not follow the Generic Marking.

*For additional information on our Pb-Free strategy and soldering details, please download the ON Semiconductor Soldering and Mounting Techniques Reference Manual, SOLDERRM/D.

STYLES ON PAGE 2

DOCUMENT NUMBER:	98ASB42564B	Electronic versions are uncontrolled except when accessed directly from the Document Repository. Printed versions are uncontrolled except when stamped "CONTROLLED COPY" in red.
DESCRIPTION:	SOIC-8 NB	PAGE 1 OF 2

onsemi and ONsemi are trademarks of Semiconductor Components Industries, LLC dba onsemi or its subsidiaries in the United States and/or other countries. onsemi reserves the right to make changes without further notice to any products herein. onsemi makes no warranty, representation or guarantee regarding the suitability of its products for any particular purpose, nor does onsemi assume any liability arising out of the application or use of any product or circuit, and specifically disclaims any and all liability, including without limitation special, consequential or incidental damages. onsemi does not convey any license under its patent rights nor the rights of others.

SOIC-8 NB
CASE 751-07
ISSUE AK

DATE 16 FEB 2011

- | | | | |
|---|--|--|--|
| <p>STYLE 1:
 PIN 1. EMITTER
 2. COLLECTOR
 3. COLLECTOR
 4. EMITTER
 5. EMITTER
 6. BASE
 7. BASE
 8. EMITTER</p> | <p>STYLE 2:
 PIN 1. COLLECTOR, DIE, #1
 2. COLLECTOR, #1
 3. COLLECTOR, #2
 4. COLLECTOR, #2
 5. BASE, #2
 6. EMITTER, #2
 7. BASE, #1
 8. EMITTER, #1</p> | <p>STYLE 3:
 PIN 1. DRAIN, DIE #1
 2. DRAIN, #1
 3. DRAIN, #2
 4. DRAIN, #2
 5. GATE, #2
 6. SOURCE, #2
 7. GATE, #1
 8. SOURCE, #1</p> | <p>STYLE 4:
 PIN 1. ANODE
 2. ANODE
 3. ANODE
 4. ANODE
 5. ANODE
 6. ANODE
 7. ANODE
 8. COMMON CATHODE</p> |
| <p>STYLE 5:
 PIN 1. DRAIN
 2. DRAIN
 3. DRAIN
 4. DRAIN
 5. GATE
 6. GATE
 7. SOURCE
 8. SOURCE</p> | <p>STYLE 6:
 PIN 1. SOURCE
 2. DRAIN
 3. DRAIN
 4. SOURCE
 5. SOURCE
 6. GATE
 7. GATE
 8. SOURCE</p> | <p>STYLE 7:
 PIN 1. INPUT
 2. EXTERNAL BYPASS
 3. THIRD STAGE SOURCE
 4. GROUND
 5. DRAIN
 6. GATE 3
 7. SECOND STAGE Vd
 8. FIRST STAGE Vd</p> | <p>STYLE 8:
 PIN 1. COLLECTOR, DIE #1
 2. BASE, #1
 3. BASE, #2
 4. COLLECTOR, #2
 5. COLLECTOR, #2
 6. EMITTER, #2
 7. EMITTER, #1
 8. COLLECTOR, #1</p> |
| <p>STYLE 9:
 PIN 1. EMITTER, COMMON
 2. COLLECTOR, DIE #1
 3. COLLECTOR, DIE #2
 4. EMITTER, COMMON
 5. EMITTER, COMMON
 6. BASE, DIE #2
 7. BASE, DIE #1
 8. EMITTER, COMMON</p> | <p>STYLE 10:
 PIN 1. GROUND
 2. BIAS 1
 3. OUTPUT
 4. GROUND
 5. GROUND
 6. BIAS 2
 7. INPUT
 8. GROUND</p> | <p>STYLE 11:
 PIN 1. SOURCE 1
 2. GATE 1
 3. SOURCE 2
 4. GATE 2
 5. DRAIN 2
 6. DRAIN 2
 7. DRAIN 1
 8. DRAIN 1</p> | <p>STYLE 12:
 PIN 1. SOURCE
 2. SOURCE
 3. SOURCE
 4. GATE
 5. DRAIN
 6. DRAIN
 7. DRAIN
 8. DRAIN</p> |
| <p>STYLE 13:
 PIN 1. N.C.
 2. SOURCE
 3. SOURCE
 4. GATE
 5. DRAIN
 6. DRAIN
 7. DRAIN
 8. DRAIN</p> | <p>STYLE 14:
 PIN 1. N-SOURCE
 2. N-GATE
 3. P-SOURCE
 4. P-GATE
 5. P-DRAIN
 6. P-DRAIN
 7. N-DRAIN
 8. N-DRAIN</p> | <p>STYLE 15:
 PIN 1. ANODE 1
 2. ANODE 1
 3. ANODE 1
 4. ANODE 1
 5. CATHODE, COMMON
 6. CATHODE, COMMON
 7. CATHODE, COMMON
 8. CATHODE, COMMON</p> | <p>STYLE 16:
 PIN 1. EMITTER, DIE #1
 2. BASE, DIE #1
 3. EMITTER, DIE #2
 4. BASE, DIE #2
 5. COLLECTOR, DIE #2
 6. COLLECTOR, DIE #2
 7. COLLECTOR, DIE #1
 8. COLLECTOR, DIE #1</p> |
| <p>STYLE 17:
 PIN 1. VCC
 2. V2OUT
 3. V1OUT
 4. TXE
 5. RXE
 6. VEE
 7. GND
 8. ACC</p> | <p>STYLE 18:
 PIN 1. ANODE
 2. ANODE
 3. SOURCE
 4. GATE
 5. DRAIN
 6. DRAIN
 7. CATHODE
 8. CATHODE</p> | <p>STYLE 19:
 PIN 1. SOURCE 1
 2. GATE 1
 3. SOURCE 2
 4. GATE 2
 5. DRAIN 2
 6. MIRROR 2
 7. DRAIN 1
 8. MIRROR 1</p> | <p>STYLE 20:
 PIN 1. SOURCE (N)
 2. GATE (N)
 3. SOURCE (P)
 4. GATE (P)
 5. DRAIN
 6. DRAIN
 7. DRAIN
 8. DRAIN</p> |
| <p>STYLE 21:
 PIN 1. CATHODE 1
 2. CATHODE 2
 3. CATHODE 3
 4. CATHODE 4
 5. CATHODE 5
 6. COMMON ANODE
 7. COMMON ANODE
 8. CATHODE 6</p> | <p>STYLE 22:
 PIN 1. I/O LINE 1
 2. COMMON CATHODE/VCC
 3. COMMON CATHODE/VCC
 4. I/O LINE 3
 5. COMMON ANODE/GND
 6. I/O LINE 4
 7. I/O LINE 5
 8. COMMON ANODE/GND</p> | <p>STYLE 23:
 PIN 1. LINE 1 IN
 2. COMMON ANODE/GND
 3. COMMON ANODE/GND
 4. LINE 2 IN
 5. LINE 2 OUT
 6. COMMON ANODE/GND
 7. COMMON ANODE/GND
 8. LINE 1 OUT</p> | <p>STYLE 24:
 PIN 1. BASE
 2. EMITTER
 3. COLLECTOR/ANODE
 4. COLLECTOR/ANODE
 5. CATHODE
 6. CATHODE
 7. COLLECTOR/ANODE
 8. COLLECTOR/ANODE</p> |
| <p>STYLE 25:
 PIN 1. VIN
 2. N/C
 3. REXT
 4. GND
 5. IOUT
 6. IOUT
 7. IOUT
 8. IOUT</p> | <p>STYLE 26:
 PIN 1. GND
 2. dv/dt
 3. ENABLE
 4. ILIMIT
 5. SOURCE
 6. SOURCE
 7. SOURCE
 8. VCC</p> | <p>STYLE 27:
 PIN 1. ILIMIT
 2. OVLO
 3. UVLO
 4. INPUT+
 5. SOURCE
 6. SOURCE
 7. SOURCE
 8. DRAIN</p> | <p>STYLE 28:
 PIN 1. SW_TO_GND
 2. DASIC_OFF
 3. DASIC_SW_DET
 4. GND
 5. V_MON
 6. VBULK
 7. VBULK
 8. VIN</p> |
| <p>STYLE 29:
 PIN 1. BASE, DIE #1
 2. EMITTER, #1
 3. BASE, #2
 4. EMITTER, #2
 5. COLLECTOR, #2
 6. COLLECTOR, #2
 7. COLLECTOR, #1
 8. COLLECTOR, #1</p> | <p>STYLE 30:
 PIN 1. DRAIN 1
 2. DRAIN 1
 3. GATE 2
 4. SOURCE 2
 5. SOURCE 1/DRAIN 2
 6. SOURCE 1/DRAIN 2
 7. SOURCE 1/DRAIN 2
 8. GATE 1</p> | | |

DOCUMENT NUMBER:	98ASB42564B	Electronic versions are uncontrolled except when accessed directly from the Document Repository. Printed versions are uncontrolled except when stamped "CONTROLLED COPY" in red.
DESCRIPTION:	SOIC-8 NB	PAGE 2 OF 2

onsemi and **ONSEMI** are trademarks of Semiconductor Components Industries, LLC dba **onsemi** or its subsidiaries in the United States and/or other countries. **onsemi** reserves the right to make changes without further notice to any products herein. **onsemi** makes no warranty, representation or guarantee regarding the suitability of its products for any particular purpose, nor does **onsemi** assume any liability arising out of the application or use of any product or circuit, and specifically disclaims any and all liability, including without limitation special, consequential or incidental damages. **onsemi** does not convey any license under its patent rights nor the rights of others.

onsemi, **Onsemi**, and other names, marks, and brands are registered and/or common law trademarks of Semiconductor Components Industries, LLC dba "**onsemi**" or its affiliates and/or subsidiaries in the United States and/or other countries. **onsemi** owns the rights to a number of patents, trademarks, copyrights, trade secrets, and other intellectual property. A listing of **onsemi**'s product/patent coverage may be accessed at www.onsemi.com/site/pdf/Patent-Marking.pdf. **onsemi** reserves the right to make changes at any time to any products or information herein, without notice. The information herein is provided "as-is" and **onsemi** makes no warranty, representation or guarantee regarding the accuracy of the information, product features, availability, functionality, or suitability of its products for any particular purpose, nor does **onsemi** assume any liability arising out of the application or use of any product or circuit, and specifically disclaims any and all liability, including without limitation special, consequential or incidental damages. Buyer is responsible for its products and applications using **onsemi** products, including compliance with all laws, regulations and safety requirements or standards, regardless of any support or applications information provided by **onsemi**. "Typical" parameters which may be provided in **onsemi** data sheets and/or specifications can and do vary in different applications and actual performance may vary over time. All operating parameters, including "Typicals" must be validated for each customer application by customer's technical experts. **onsemi** does not convey any license under any of its intellectual property rights nor the rights of others. **onsemi** products are not designed, intended, or authorized for use as a critical component in life support systems or any FDA Class 3 medical devices or medical devices with a same or similar classification in a foreign jurisdiction or any devices intended for implantation in the human body. Should Buyer purchase or use **onsemi** products for any such unintended or unauthorized application, Buyer shall indemnify and hold **onsemi** and its officers, employees, subsidiaries, affiliates, and distributors harmless against all claims, costs, damages, and expenses, and reasonable attorney fees arising out of, directly or indirectly, any claim of personal injury or death associated with such unintended or unauthorized use, even if such claim alleges that **onsemi** was negligent regarding the design or manufacture of the part. **onsemi** is an Equal Opportunity/Affirmative Action Employer. This literature is subject to all applicable copyright laws and is not for resale in any manner.

PUBLICATION ORDERING INFORMATION

LITERATURE FULFILLMENT:

Email Requests to: orderlit@onsemi.com

onsemi Website: www.onsemi.com

TECHNICAL SUPPORT

North American Technical Support:

Voice Mail: 1 800-282-9855 Toll Free USA/Canada

Phone: 011 421 33 790 2910

Europe, Middle East and Africa Technical Support:

Phone: 00421 33 790 2910

For additional information, please contact your local Sales Representative