

# MBRAF440, NRVBAF440

## Surface Mount Schottky Power Rectifier

This device employs the Schottky Barrier principle in a large area metal-to-silicon power diode. State-of-the-art geometry features epitaxial construction with oxide passivation and metal overlay contact. Ideally suited for low voltage, high frequency rectification, or as free wheeling and polarity protection diodes in surface mount applications where compact size and weight are critical to the system.

### Features

- Low Profile Package for Space Constrained Applications
- Rectangular Package for Automated Handling
- Highly Stable Oxide Passivated Junction
- 150°C Operating Junction Temperature
- Guard-Ring for Stress Protection
- NRV Prefix for Automotive and Other Applications Requiring Unique Site and Control Change Requirements; AEC-Q101 Qualified and PPAP Capable
- These are Pb-Free and Halide-Free Devices

### Mechanical Characteristics

- Case: Epoxy, Molded, Epoxy Meets UL 94, V-0
- Weight: 95 mg (approximately)
- Finish: All External Surfaces Corrosion Resistant and Terminal Leads are Readily Solderable
- Lead and Mounting Surface Temperature for Soldering Purposes: 260°C Max. for 10 Seconds
- Cathode Polarity Band
- Device Meets MSL 1 Requirements



**ON Semiconductor®**

[www.onsemi.com](http://www.onsemi.com)

**SCHOTTKY BARRIER  
RECTIFIER  
4.0 AMPERE  
40 VOLTS**

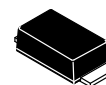

**SMA-FL  
CASE 403AA  
STYLE 6**

### MARKING DIAGRAM



RAF = Specific Device Code  
A = Assembly Location  
Y = Year  
WW = Work Week  
■ = Pb-Free Package

### ORDERING INFORMATION

Device	Package	Shipping†
MBRAF440T3G	SMA-FL (Pb-Free)	5000 / Tape & Reel
NRVBAF440T3G	SMA-FL (Pb-Free)	5000 / Tape & Reel

†For information on tape and reel specifications, including part orientation and tape sizes, please refer to our Tape and Reel Packaging Specification Brochure, BRD8011/D.

# MBRAF440, NRVBAF440

## MAXIMUM RATINGS

Rating	Symbol	Value	Unit
Peak Repetitive Reverse Voltage Working Peak Reverse Voltage DC Blocking Voltage	$V_{RRM}$ $V_{RWM}$ $V_R$	40	V
Average Rectified Forward Current (At Rated $V_R$ , $T_L = 107^\circ\text{C}$ )	$I_O$	4.0	A
Non-Repetitive Peak Surge Current (Surge Applied at Rated Load Conditions Halfwave, Single Phase, 60 Hz)	$I_{FSM}$	100	A
Storage/Operating Case Temperature	$T_{stg}$ , $T_C$	-55 to +150	$^\circ\text{C}$
Operating Junction Temperature (Note 1)	$T_J$	-55 to +150	$^\circ\text{C}$
Voltage Rate of Change (Rated $V_R$ , $T_J = 25^\circ\text{C}$ )	dv/dt	10,000	V/ $\mu\text{s}$
ESD Rating	Human Body Model Machine Model	ESD <sub>HBM</sub> ESD <sub>MM</sub>	3B M4 -

Stresses exceeding those listed in the Maximum Ratings table may damage the device. If any of these limits are exceeded, device functionality should not be assumed, damage may occur and reliability may be affected.

1. The heat generated must be less than the thermal conductivity from Junction-to-Ambient:  $dP_D/dT_J < 1/R_{\theta JA}$ .

## THERMAL CHARACTERISTICS

Characteristic	Symbol	Value	Unit
Thermal Resistance – Junction-to-Lead (Note 2)	$R_{\theta JL}$	25	$^\circ\text{C}/\text{W}$
Thermal Resistance – Junction-to-Ambient (Note 2)	$R_{\theta JA}$	90	

2. 1 inch square pad size (1 × 0.5 inch) for each lead on FR4 board.

## ELECTRICAL CHARACTERISTICS

Characteristic	Symbol	Value		Unit
		$T_J = 25^\circ\text{C}$	$T_J = 100^\circ\text{C}$	
Maximum Instantaneous Forward Voltage (Note 3) ( $I_F = 4.0\text{ A}$ )	$V_F$	0.485	0.435	V
Maximum Instantaneous Reverse Current ( $V_R = 40\text{ V}$ )	$I_R$	0.3	15	mA

Product parametric performance is indicated in the Electrical Characteristics for the listed test conditions, unless otherwise noted. Product performance may not be indicated by the Electrical Characteristics if operated under different conditions.

3. Pulse Test: Pulse Width  $\leq 250\ \mu\text{s}$ , Duty Cycle  $\leq 2.0\%$ .

# MBRAF440, NRVBAF440

## TYPICAL CHARACTERISTICS

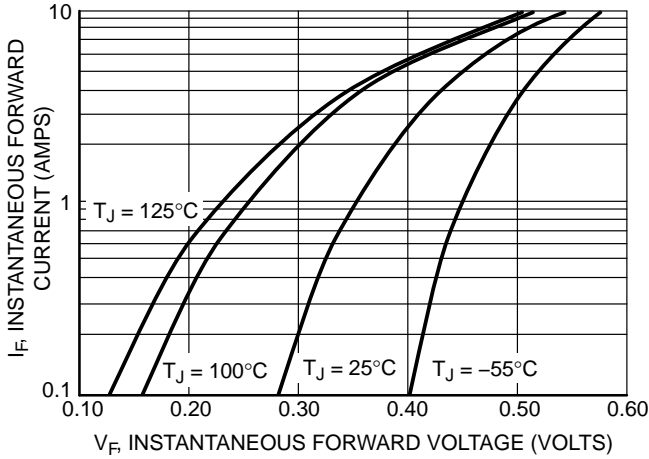

Figure 1. Typical Forward Voltage

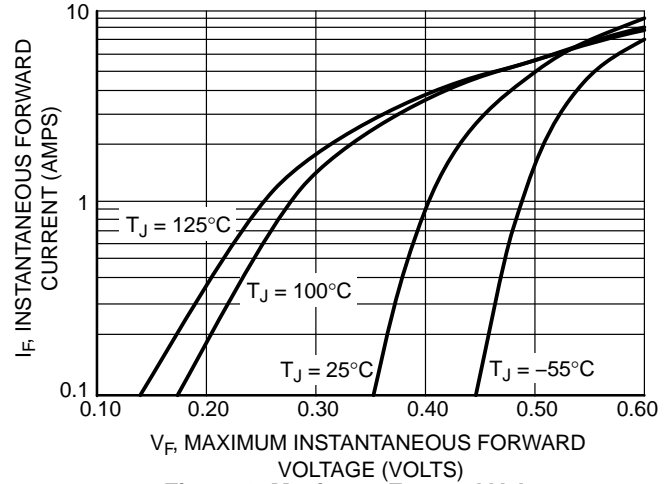

Figure 2. Maximum Forward Voltage

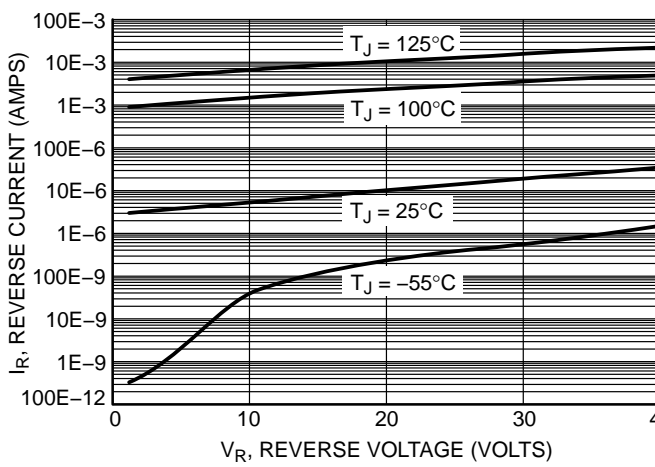

Figure 3. Typical Reverse Current

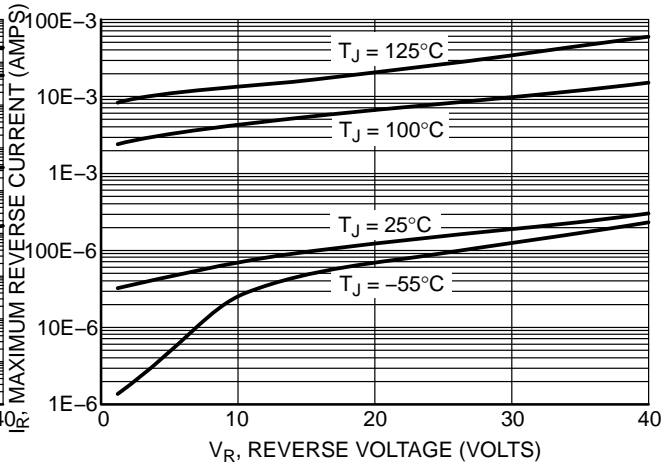

Figure 4. Maximum Reverse Current

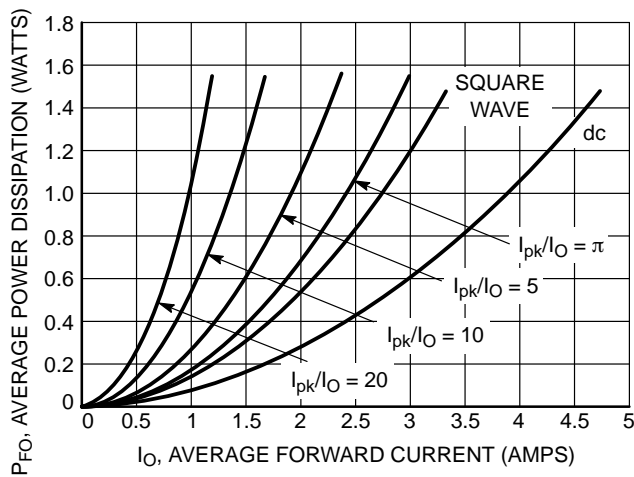

Figure 5. Forward Power Dissipation

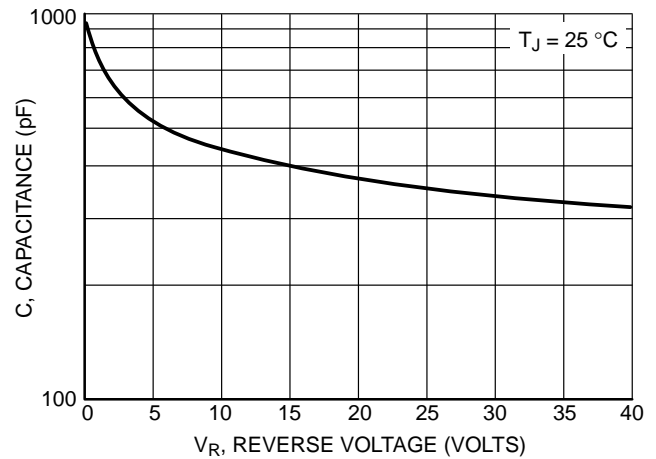

Figure 6. Capacitance

# MBRAF440, NRVBAF440

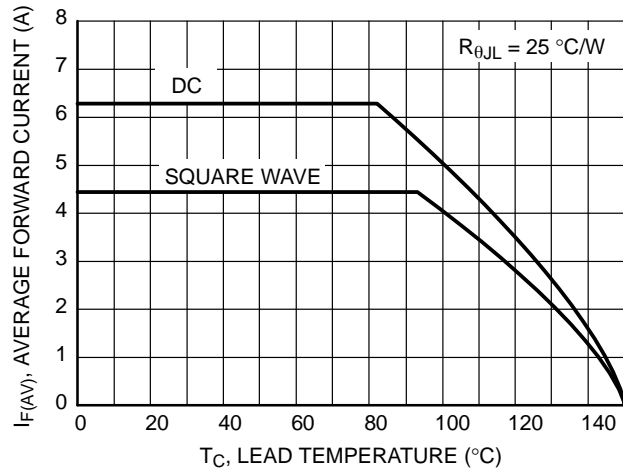

Figure 7. Current Derating

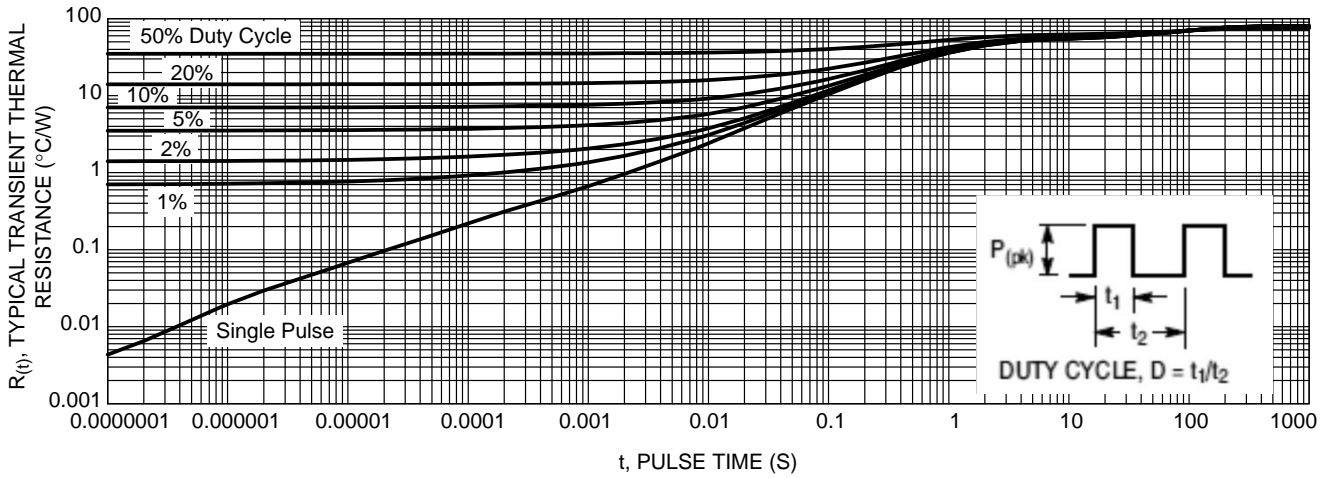
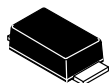

Figure 8. Typical Transient Thermal Response, Junction-to-Ambient

# MECHANICAL CASE OUTLINE

## PACKAGE DIMENSIONS

ON Semiconductor®



SCALE 2:1

SMA-FL  
CASE 403AA-01  
ISSUE O

DATE 02 MAR 2011

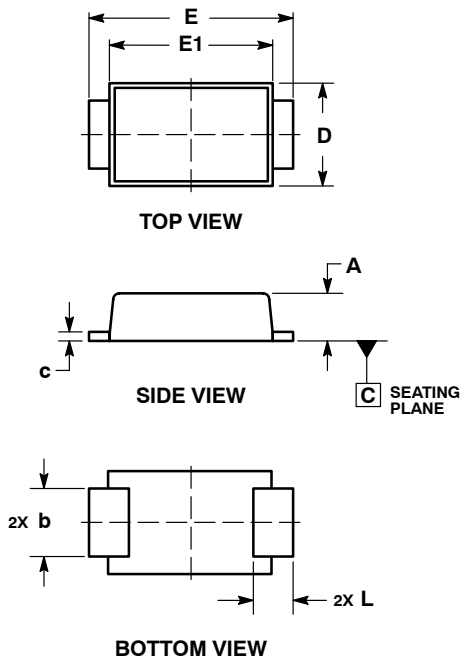

- NOTES:
1. DIMENSIONING AND TOLERANCING PER ASME Y14.5M, 1994.
  2. CONTROLLING DIMENSION: MILLIMETERS.

MILLIMETERS		
DIM	MIN	MAX
A	0.90	1.10
b	1.25	1.65
c	0.15	0.30
D	2.40	2.80
E	4.80	5.40
E1	4.00	4.60
L	0.70	1.10

### RECOMMENDED SOLDER FOOTPRINT\*

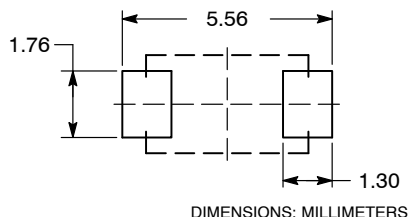

\*For additional information on our Pb-Free strategy and soldering details, please download the ON Semiconductor Soldering and Mounting Techniques Reference Manual, SOLDERRM/D.

<b>DOCUMENT NUMBER:</b>	<b>98AON55210E</b>	Electronic versions are uncontrolled except when accessed directly from the Document Repository. Printed versions are uncontrolled except when stamped "CONTROLLED COPY" in red.
<b>DESCRIPTION:</b>	<b>SMA-FL</b>	<b>PAGE 1 OF 1</b>

ON Semiconductor and are trademarks of Semiconductor Components Industries, LLC dba ON Semiconductor or its subsidiaries in the United States and/or other countries. ON Semiconductor reserves the right to make changes without further notice to any products herein. ON Semiconductor makes no warranty, representation or guarantee regarding the suitability of its products for any particular purpose, nor does ON Semiconductor assume any liability arising out of the application or use of any product or circuit, and specifically disclaims any and all liability, including without limitation special, consequential or incidental damages. ON Semiconductor does not convey any license under its patent rights nor the rights of others.

**onsemi**, **Onsemi**, and other names, marks, and brands are registered and/or common law trademarks of Semiconductor Components Industries, LLC dba "**onsemi**" or its affiliates and/or subsidiaries in the United States and/or other countries. **onsemi** owns the rights to a number of patents, trademarks, copyrights, trade secrets, and other intellectual property. A listing of **onsemi**'s product/patent coverage may be accessed at [www.onsemi.com/site/pdf/Patent-Marking.pdf](http://www.onsemi.com/site/pdf/Patent-Marking.pdf). **onsemi** reserves the right to make changes at any time to any products or information herein, without notice. The information herein is provided "as-is" and **onsemi** makes no warranty, representation or guarantee regarding the accuracy of the information, product features, availability, functionality, or suitability of its products for any particular purpose, nor does **onsemi** assume any liability arising out of the application or use of any product or circuit, and specifically disclaims any and all liability, including without limitation special, consequential or incidental damages. Buyer is responsible for its products and applications using **onsemi** products, including compliance with all laws, regulations and safety requirements or standards, regardless of any support or applications information provided by **onsemi**. "Typical" parameters which may be provided in **onsemi** data sheets and/or specifications can and do vary in different applications and actual performance may vary over time. All operating parameters, including "Typicals" must be validated for each customer application by customer's technical experts. **onsemi** does not convey any license under any of its intellectual property rights nor the rights of others. **onsemi** products are not designed, intended, or authorized for use as a critical component in life support systems or any FDA Class 3 medical devices or medical devices with a same or similar classification in a foreign jurisdiction or any devices intended for implantation in the human body. Should Buyer purchase or use **onsemi** products for any such unintended or unauthorized application, Buyer shall indemnify and hold **onsemi** and its officers, employees, subsidiaries, affiliates, and distributors harmless against all claims, costs, damages, and expenses, and reasonable attorney fees arising out of, directly or indirectly, any claim of personal injury or death associated with such unintended or unauthorized use, even if such claim alleges that **onsemi** was negligent regarding the design or manufacture of the part. **onsemi** is an Equal Opportunity/Affirmative Action Employer. This literature is subject to all applicable copyright laws and is not for resale in any manner.

## PUBLICATION ORDERING INFORMATION

### LITERATURE FULFILLMENT:

Email Requests to: [orderlit@onsemi.com](mailto:orderlit@onsemi.com)

**onsemi Website:** [www.onsemi.com](http://www.onsemi.com)

### TECHNICAL SUPPORT

**North American Technical Support:**

Voice Mail: 1 800-282-9855 Toll Free USA/Canada

Phone: 011 421 33 790 2910

**Europe, Middle East and Africa Technical Support:**

Phone: 00421 33 790 2910

For additional information, please contact your local Sales Representative