



RF Explorer[®]

User Manual

Updated to Firmware Version 1.32 for Standard models

Updated to Firmware Version 3.25 for Plus models

RF Explorer[®]

RF Explorer is an affordable Handheld Spectrum Analyzer with a growing list of features.

*This little powerful unit is the tool you need
to reduce the implementation time and cost
of your next wireless project.*



Updates of the RF Explorer User Manual are [available online](#).

Please consider the environment before printing this document.

Table of Contents

Introduction.....	5
Description of main features	6
Understanding RF Explorer Plus model	7
Understanding RF Explorer Standard model	8
Correctly handling input power levels	9
Spectrum Analyzer mode - Main Screen.....	10
Using menus.....	12
Operational Mode menu	14
Frequency Menu	16
Analyzer screen in Advanced Mode	18
Advanced: Understanding RBW.....	18
WiFi Analyzer Mode.....	20
Fine tuning WiFi deployment.....	20
Attenuator Menu	22
Configuration Menu.....	24
Preset Menu	25
Using RF Explorer Preset Manager.....	26
Record / Play MENU (PLUS model only).....	27
How to record sweeps	28
How to replay stored sweeps	29
Beep sounds	29
Registering License.....	29
Future enhancements	29
HAM Field Meter (PLUS models only).....	30
Registering License.....	31
How to measure field strength	31
HELP button (Plus model only).....	33
RF Generator mode.....	34
RF Explorer internal battery	36
Charging the internal battery	36
Using the Battery dedicated screen	37
Charging a fully depleted battery.....	39
Automatic idle mode with battery charge	39
Expansion Modules.....	40
RF Explorer antennas	41
Telescopic dual band 144/430MHz	41

UHF 400-900MHz antenna	41
Whip dipole antennas	42
Rubber duck 5.8GHz antenna.....	42
Additional antennas.....	43
LTE antenna	43
Cloverleaf dual band 2.4 / 5.8Ghz omnidirectional	43
Directional Patch SMA Articulated Antenna, versions for 5.8Ghz and 2.4Ghz	44
RF Explorer Near Field antennas.....	44
Protecting your instrument from damage.....	47
External Attenuators.....	49
6GHz SMA Attenuator – 60dB	49
6GHz SMA Attenuator - 10dB.....	50
6GHz SMA Attenuator - 30dB.....	50
RF Explorer Power Limiter	51
RF Explorer Holder – PLUS SLIM version.....	53
RF Explorer Holder – Standard version	54
RF Explorer accessories	55
SMA-BNC adapter SMA Plug to BNC Jack straight	55
SMA-N adapter SMA Plug to N Jack straight	55
RF Adapter RP-SMA Jack to SMA Plug straight-long version.....	56
SMA adapter SMA Plug to SMA Jack right angle.....	56
SMA connection cables	57
10cm length - SMA male to SMA female 6GHz coaxial cable	57
10cm length - SMA male to SMA male 6GHz coaxial cable	57
50cm length - SMA male to SMA female RF pigtail Coaxial Cable RG316.....	58
50cm length - SMA male to SMA male plug pigtail cable RG316	58
SMA Male/Female Adaptor	58
SMA Termination – 50 ohm dummy load.....	59
Connecting RF Explorer to a computer	60
API SDK programming specification for RF Explorer	60
RF Explorer for Windows open source code	60
Specifications.....	61
Acknowledgments	61
FCC and CE regulations	61
License.....	61

Introduction

RF Explorer has been designed to be intuitive and easy to use. There is no need to read large user manuals to get advantage of its advanced functionality.

Most of the complexity inherent to full sized Spectrum Analyzers is simplified with automatic functionality resolved by the firmware. For instance, you do not need to adjust Resolution Bandwidth (RBW) every time you select a different frequency span. Actually, you do not even need to know what RBW is. You can progress in your RF learning curve and come back to this manual and online tutorial anytime.

We welcome your feedback and look for ideas to make this manual more useful. Please contribute with ideas, suggestions, typo corrections and comments on the official discussion list

www.rf-explorer.com/forum

Description of main features

- ✓ Pocket size and light weight with solid aluminum metal case.
- ✓ The Spectrum Analyzer calculator includes Peak Max, Max Hold, Normal, Overwrite and Averaging modes.
- ✓ Lifetime free firmware upgrades available.
- ✓ Open to new features requested by user community.
- ✓ High capacity Lithium Ion battery up to 16hs of continuous run, rechargeable by USB.
- ✓ Microsoft Windows software is free and Open Source.
- ✓ Mac OS client is free and Open Source.
- ✓ USB Communication protocol is open for custom solutions and extensions.
- ✓ Different RF Explorer models available:
 - General purpose high frequency model: 50KHz to 6100MHz
 - General purpose wideband model: 15 – 2700MHz
 - Wideband UHF - ISM models: 50KHz - 960MHz and 2350 - 2550MHz
 - Narrow band ISM models: 2.4GHz, 433MHz, 868MHz or 915MHz band
- ✓ Expandable: RF Explorer base model unit can be easily expanded to additional bands using the internal expansion port.
- ✓ Some models include an Integrated RF Signal Generator.
- ✓ For more details on different models and capabilities available, please check online

www.rf-explorer.com/models

Understanding RF Explorer Plus model

There are two versions of RF Explorer PLUS models, the more recent model design is the SLIM design with fully molded metallic structure and finished with high quality varnished paint

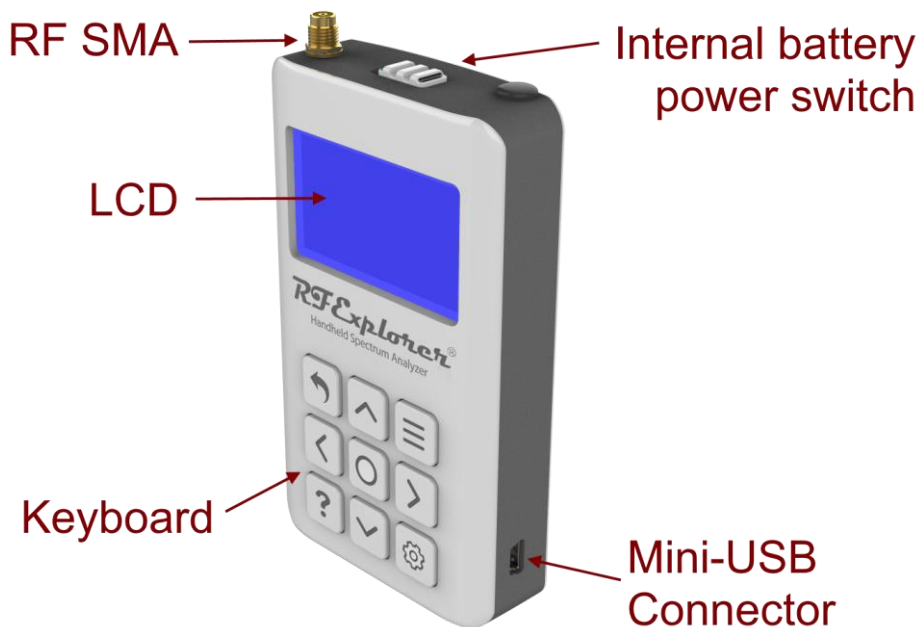

While the slightly older aluminum design is functionally equivalent

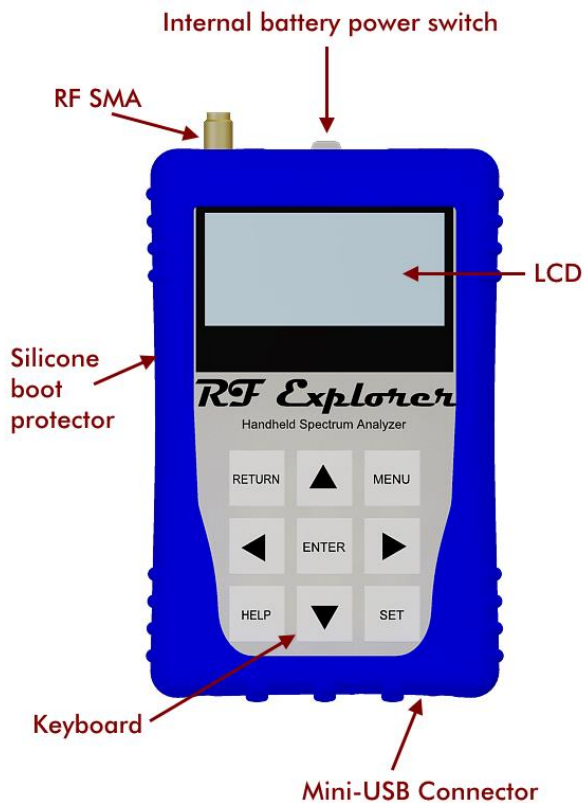

The RF Explorer Plus models includes 9 functional buttons in the front side, including context sensitive HELP and easy preset handling with SET button, and a silicone rubber protector. The unit also includes at least one RF connector 50 ohm impedance standard SMA format.

All models have a SMA left connector installed and, optionally, some models have a second SMA connector at the right position for extended range and functionality. For more details see the section Expansion Modules in page 40.

The unit will automatically start running on USB power when a compatible mini-USB cable is connected.

Important: The internal battery power switch must be in the ON position for the battery to charge when the USB cable is connected. The internal battery will not charge when the power switch is in the OFF position.

Note: There are a number of SMA adapters to easily interface RF Explorer SMA connector to any other standard RF connector format, including BNC, N, RP-SMA, etc. For more information of adapters available see section *RF Explorer accessories* in page 55.

Understanding RF Explorer Standard model

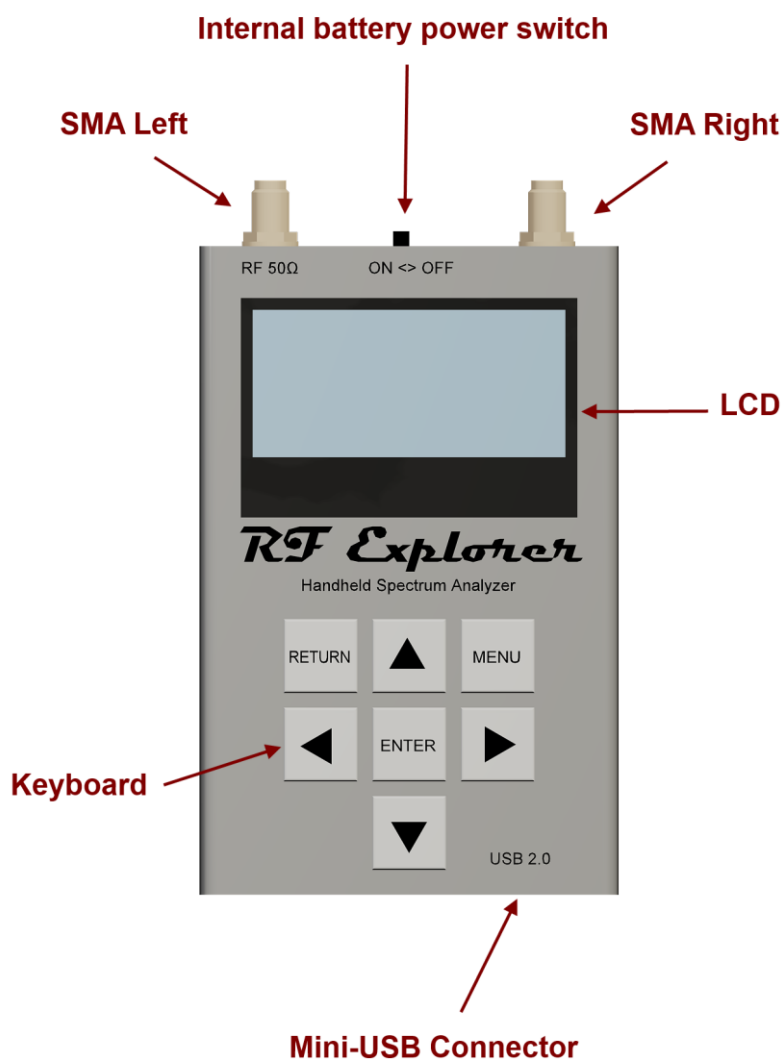

The RF Explorer Standard models includes 7 functional buttons in the front side. The unit also includes at least one RF connector 50 ohm impedance standard SMA format.

All models have a SMA left connector installed and, optionally, some models have a second SMA connector at the right position for extended range and functionality. For more details see the section Expansion Modules in page 40.

The unit will automatically start running on USB power when a compatible mini-USB cable is connected.

Important: The internal battery power switch must be in the ON position for the battery to charge when the USB cable is connected. The internal battery will not charge when the power switch is in the OFF position.

Note: There are a number of SMA adapters to easily interface RF Explorer SMA connector to any other standard RF connector format, including BNC, N, RP-SMA, etc. For more information of adapters available see section *RF Explorer accessories* in page 55.

Correctly handling input power levels

RF Explorer is specifically designed to get best results in low power signal detection using antennas. Most measurements can be performed directly with no extra precautions. For best results, you may need to use external attenuators if working with powerful signals.

Measurable input range	Recommended external attenuator
Lower than -30dBm / 1 micro Watt	No need
-30 to 0dBm / 1 microWatt to 1 milliWatt	30dB external or internal
-30 to 10dBm / 1 microWatt to 10 milliWatt	40dB external
0 to 33dBm / 1 milliWatt to 2 Watt	60dB external

Note there are three different power levels types to know when using spectrum analyzers, from lower to higher:

- **Measurable input range:** This range includes all levels the analyzer can correctly measure without distortion or false reading. **The above table shows typical levels for RF Explorer, see section *External Attenuators* in page 49 for recommended accessories to correctly perform any measurement you may need.**
- **Safe but not measurable range:** In this range the instrument will not get damage, the measurement will be distorted and, in most cases, incorrect. Read section *Protecting your instrument from damage* in page 47.
- **Damage range:** In this range the instrument may get permanent damage and readings may be incorrect at any time.

RF Explorer models with internal Attenuator and LNA offer added flexibility to work with different input signal levels.

Spectrum Analyzer mode - Main Screen

Upon start, RF Explorer goes to Spectrum Analyzer mode automatically.

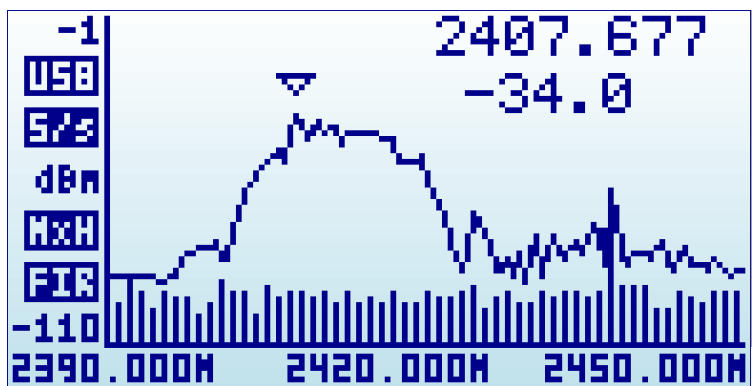

The X axis represents frequency in MHz and Y axis display actual received power in dBm or dBuV (selectable). In this example above, the frequency span goes from 2390 MHz to 2450 MHz (that is a 60MHz range), and the visual amplitude goes from -1 dBm to -110 dBm.

Configuration settings such as amplitude reference and frequency span are preserved between sessions, stored in internal FLASH memory.

The main screen automatically displays a small marker with a triangle shape. This will indicate the peak amplitude found in the current frequency span, being the first text line the frequency in MHz and the second line the amplitude at that particular point.

The main screen has a number of additional indicators:

RF Explorer Spectrum Analyzer screen

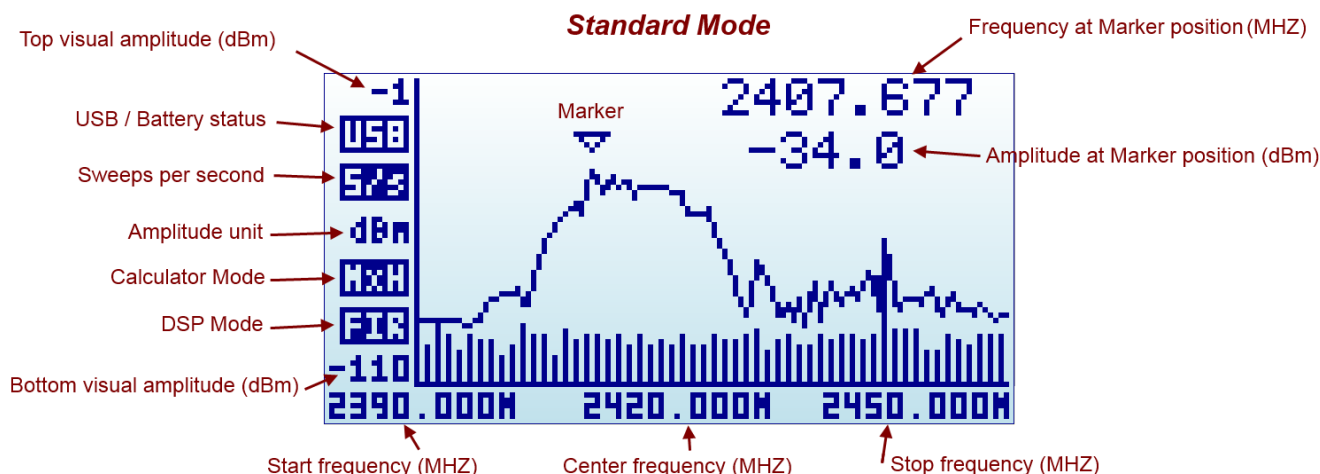

The available indicators are:

- **USB / battery status:** this indicator will display USB¹ when a valid 5V USB connection is available. This will be true even if the connection is through a wall wart charger, so it does not actually means a data connection but a power bus connection. Alternatively, a battery icon with charge level indicator will display when the RF Explorer unit power switch is set to ON. If both connections are enabled, then USB and Battery will alternate and, in this case, the battery will be charging.
- **Sweeps per second:** this is an approximate value of the number of full screen sweeps happening every second. In the example above, there are 5 sweeps per second or, in equivalent terms, one sweep every 200ms.
- **Calculator mode:** this indicator may have different values as specified by the Calculator mode in the frequency menu. Please check the section Frequency Menu in page 16.
- **DSP mode:** this indicator shows the actual value being used by the Analyzer. The *DSP:Auto* is the recommended setting in the Frequency Menu (see page 16) so RF Explorer will select the best possible option as per below:
 - **FST:** Fast mode. This is the standard mode available in all models.
 - **FIR:** Filter mode. This is available in the 15-2700MHZ and Plus modules only, and is the recommended one for those models.
- **Marker:** There are different operational modes for the marker, see Configuration Menu in page 24.

The analyzer screen can be turned into advanced mode using the [Return] key:

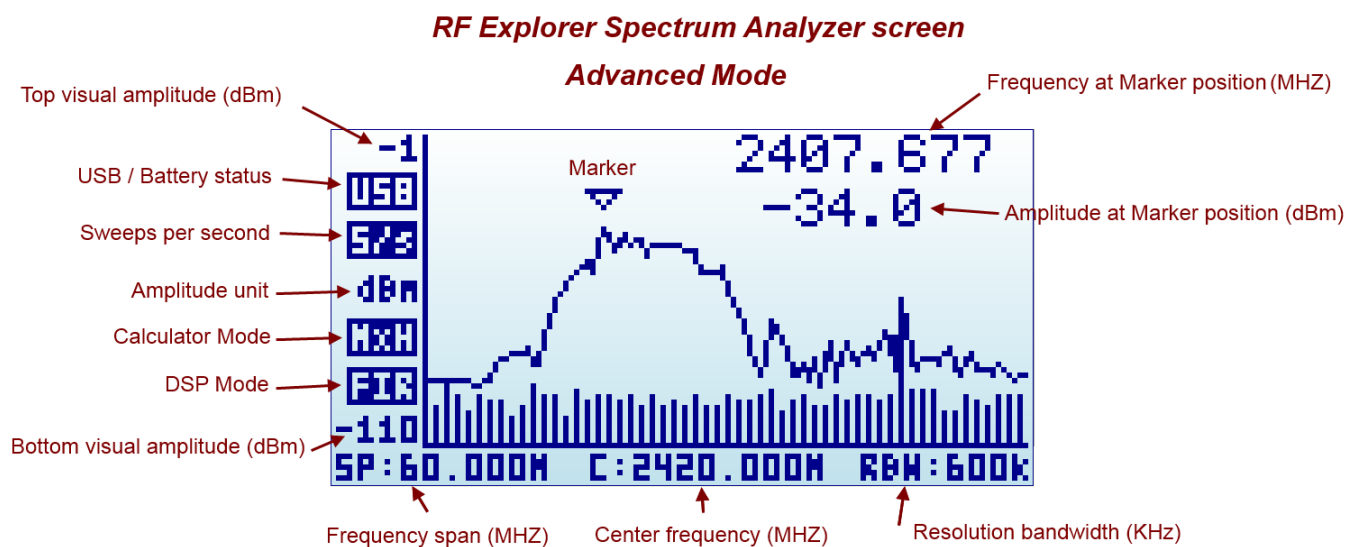

Note the frequency axis indicators changes at the bottom. More details about this screen mode in section *Analyzer screen* page 18.

¹ USB refers to Universal Serial Bus, the standard connectivity bus in all modern computers. Our fellow HAM users should not confuse this with Upper Side Band communication, even though uses the same mnemonic.

Using menus

There are several menus in RF Explorer. They are organized on different screens, which you can iterate through by using the [Menu] key. If you click [Menu] button multiple times, you will visit every one of them:

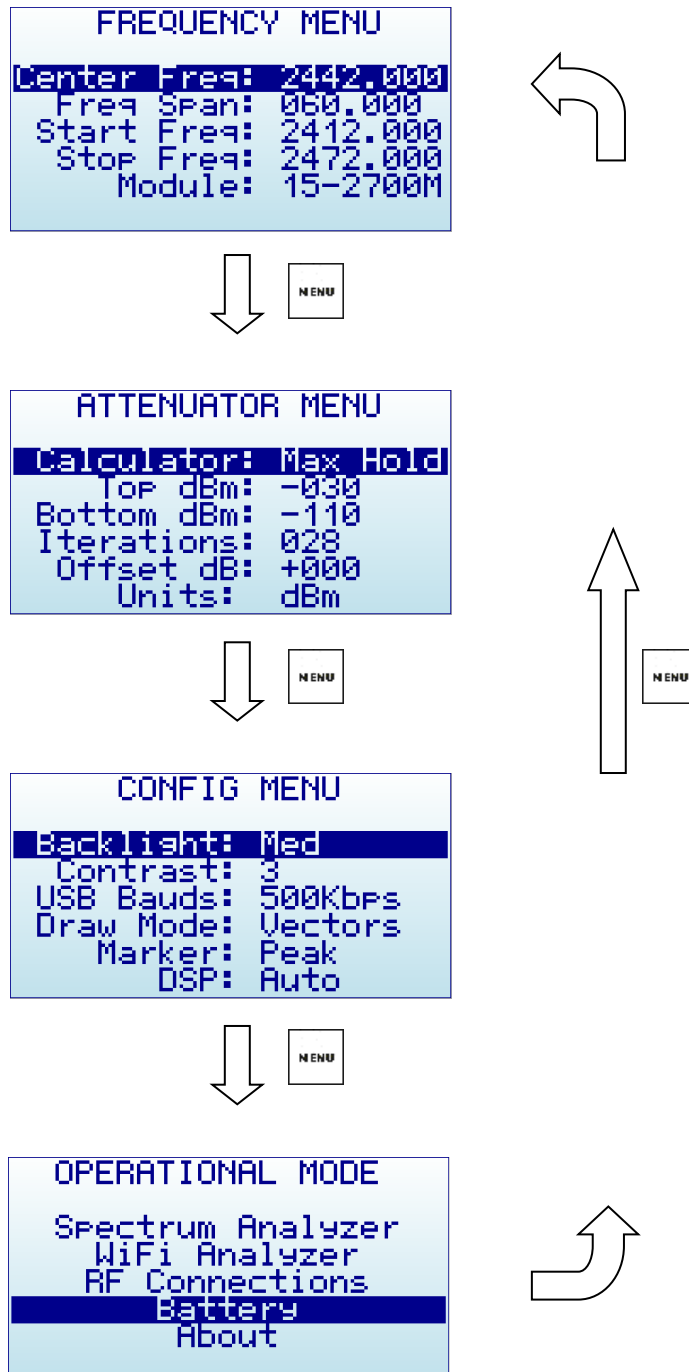

Optionally, you can use the [Left] and [Right] keys to go from one screen to another.

You can exit from a menu anytime by using the [Return] key.

The first time you click on [Menu] button in a RF Explorer session, Frequency Menu will open. This may change as we will see later, so every time you click on [Menu] from Spectrum Analyzer main screen, you

actually re-open the last menu you were working with. In this way you save time by not having to navigate through all the menus to go the same place you were before.

Operational Mode menu

The menu display different functional modes available in your Analyzer.



Use [Up] and [Down] arrow keys to select the desired mode and click on [Enter] to activate it immediately.

- **Spectrum Analyzer** mode is the default mode, available in all RF Explorer models
- **RF Generator** option is available in some models only. These include models ISM Combo, 2.4G, 433M, 868M and 915M, other models do not have internal RF Generator circuit. In such case, the *RF Generator* option will not display in the OPERATION MENU.

If your analyzer includes two modules (e.g. ISM Combo) only one of the modules may include RF Generator. Please select the correct module for *RF Generator* to be available.

- **WiFi Analyzer** is available in a subset of models only, including 2.4G/PLUS, 4G/6G Combo PLUS, 3G Combo, 6G Combo, WiFi Combo and ISM Combo. In other models the *WiFi Analyzer* option will not be visible or available.
- **RF Connections** enumerates the installed RF modules and how each one is connected to each SMA RF port. This example below shows a standard 3G Combo with a 240-960MHz connection on the left port, and 15-2700MHz on the right port. Click on any key to get out of this screen.

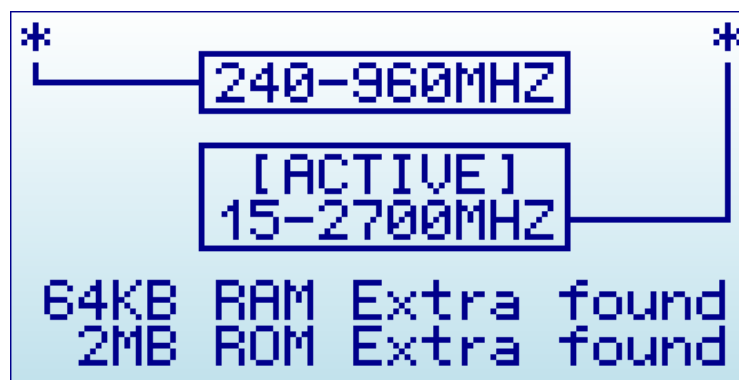

- **Battery** includes details on internal battery charge level, and assist you on charging the unit when connected to USB. For more details read section *Charging the internal battery* on page 36.

- **About** displays information about installed firmware and versioning. Use any key to get out of this screen.

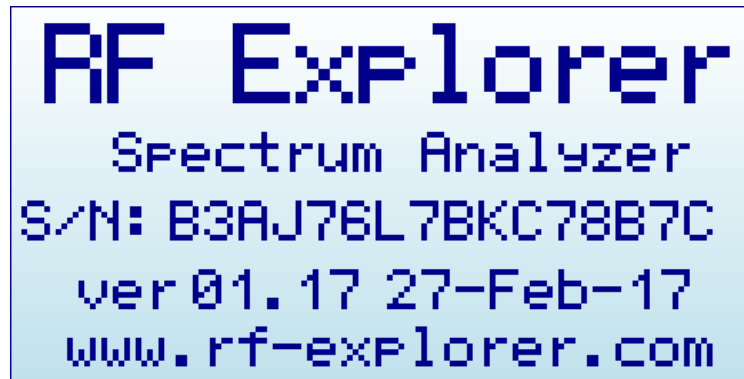

RF Explorer
Spectrum Analyzer
S/N: B3AJ76L7BKC78B7C
ver 01.17 27-Feb-17
www.rf-explorer.com

Frequency Menu

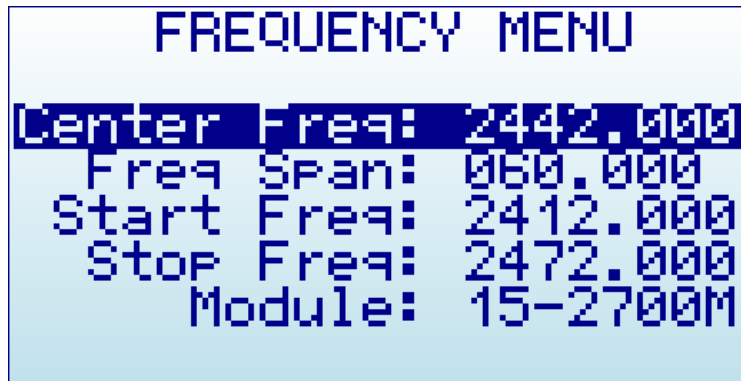

- **Center Freq:** Center frequency in MHZ
- **Freq Span:** Frequency span (or range) to display on screen in MHZ
- **Start Freq:** Lower frequency range to display on screen in MHZ
- **Stop Freq:** Higher frequency range to display on screen in MHZ
- **Module:** Active selected RF module. When an expansion module is installed, click [Enter] key to enable the module you need.

The selected frequency band to display can be specified in two different but complementary ways:

- **Center/Span:** This is the traditional Spectrum Analyzer format all engineers are used to. You basically select the Center frequency at which the band will be displayed, and then a Frequency Span.
- **Start/Stop:** This alternative mode is very useful to select frequency range between two frequencies of interest, with no need to manually calculate the Center or the Span.

The valid values for Frequency and Span are defined based on RF Explorer model and operational mode.

As you edit Center/Span or Start/Stop, the other values are updated accordingly, so feel free to use the method you prefer. In general, you will use Center/Span more frequently when you know the frequency you want to look at, and probably Start/Stop when you just want to look at a larger span to see what is happening in a specific range.

To navigate through the menu, just use [Up] and [Down] keys to go to the option you want, then click on [Enter] to edit that option, [Left] or [Right] to go to the digit you want to change, and [Enter] to confirm or [Return] to cancel.

As an example, a center frequency of 430MHz with a 20MHz span:



A click on [Menu] button will open the Frequency Menu:

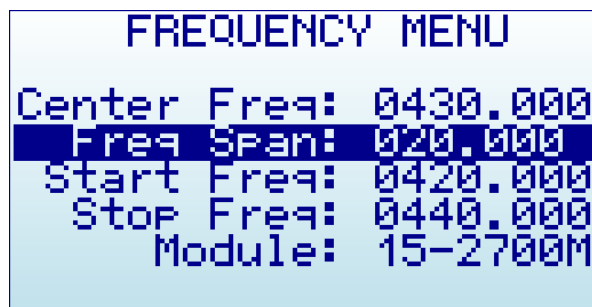

Selecting a span of 10MHz, the Start/Stop frequency changes accordingly:

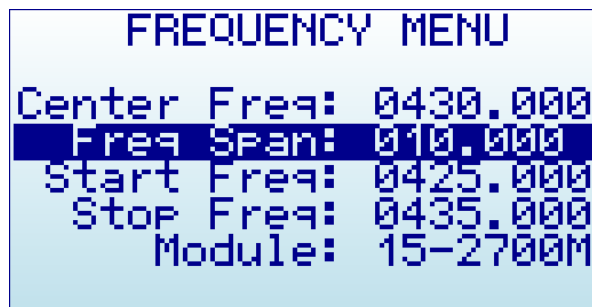

A click on [Return] button will close the menu and go back to Spectrum Analyzer main screen.



Note: While RF Explorer Spectrum Analyzer screen is enabled, the [Left] and [Right] buttons can be used to increase or decrease the Start/Stop frequency, virtually moving the visible spectrum to the left or the right 25% on every key press. This is helpful in order to offset the visual range without need to specify a new numeric range.

Analyzer screen in Advanced Mode

Alternatively, there is a simpler way to increase and decrease frequency span while keeping the center frequency. As this is a usual workflow, the RF Explorer Spectrum Analyzer screen enables the [Return] key to switch between standard visualization mode and advanced mode.



In this screen above, the frequency reading at the bottom changed from Start/Center/Stop frequency to Span/Center/RBW. When this mode is enabled, a key press on [Left] or [Right] button will increase or decrease to double and half frequency span respectively.

As an example, to increase the span from 10MHz to 20MHz, a single click to the [Left] button is enough, no need to go back to the Frequency Menu.

Advanced: Understanding RBW

The advanced mode displays the currently selected RBW (Resolution Band Width). This is an important concept for advanced users.

The RBW references the internal filter used to discriminate the bandwidth of each sweep step. In RF Explorer, each measurement dot represents a range of frequencies, and there are exactly 112 steps on each sweep. As an example, in a 10MHz span, each of the 112 measurement steps represents $10\text{MHz}/112=0.089\text{MHz}$ or, in other words, 89KHz².

The range of frequencies represented on each sweep step is a level of uncertainty; screen resolution is limited to that RBW. With a resolution of 89KHz on screen (for a 10MHz span), the best accuracy expected is exactly that value. In other words, a frequency reading of 430.100MHz on screen may mean a range of $\pm 44.5\text{KHz}$ each side, as the filter will not discriminate further than that for a 10MHz span.

In addition to that, RBW has an important impact on the sensitivity of the Spectrum Analyzer. The wider the filter bandwidth, the higher the spectral noise and therefore the lower the sensitivity. This is visible by an increasing noise floor as the RBW is larger, and lower noise floor as the RBW is narrower. Based on this, the narrowest RBW would look like the better choice for all measurements but as you get a narrower RBW you also decrease the scan speed notably, due to the slower nature of narrow filter as well as the need to measure more sweep points to cover the full span.

² Note the actual value used by the device may differ from the value calculated, due to finite tabulated choices.

To put it simple: Selecting the best combination of RBW, scan speed and sensitivity requires significant experience. In most Spectrum Analyzers, operator needs to fully understand and select RBW for each measurement, being this one of the most challenging aspects of proper Spectrum Analyzer usage.

Fortunately, this is not the case with RF Explorer: The design of the internal DSP includes sophisticated internal tables and algorithms to make the best possible choice at all times automatically. No user intervention is required to get the best compromise between scan speed, noise floor and sensitivity every time.

In all cases, the internal RBW can be checked anytime on the advanced screen mode.

WiFi Analyzer Mode

The WiFi analyzer is a channelized mode where specific WiFi channels are individually detected and represented real time.

RF Explorer WiFi Analyzer screen

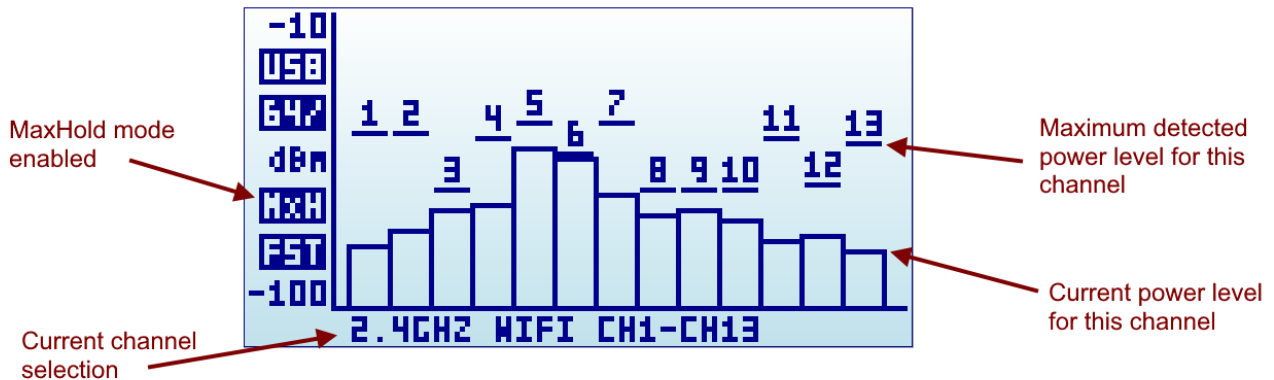

Use [RETURN] button to recycle a MaxHold capture
Use [LEFT]/[RIGHT] buttons to cycle through available channels (only in 6G Combo/PLUS models)

There are two WiFi bands supported, depending on the model:

- RF Explorer 2.4G, 4G Combo PLUS and ISM Combo/PLUS: 2.4GHz band
- RF Explorer 6G Combo/PLUS and WiFi Combo: 2.4GHz and 5GHz bands

For 2.4GHz band, 13 channels are supported but note some regions may only have 11 channels available for actual usage, in such case channels 12-13 must be ignored.

Due to the specific design of the 802.11 2.4GHz WiFi band, channels are overlapped and therefore activity in one channel has direct impact in nearby channels. This cannot be avoided in any WiFi setup, and your RF Explorer will help you detect which channels have less activity to correctly select the best suitable ones.

For the 5GHz band, up to 28 operational channels are supported in firmware v3.16 (for PLUS models) and v1.31 (for Standard models). Different regions may allow a subset of them, and depending on the technology used by the WiFi access point, some of the channels can be grouped together to increase data throughput.

Due to screen size limitations, only 13 channels can be shown on screen at a time. To iterate through all the channels, use [LEFT]/[RIGHT] keys.

For multi-band 6G Combo PLUS, the [LEFT]/[RIGHT] keys will allow to iterate not only through the 5GHz channels but also show the 2.4GHz channels.

Fine tuning WiFi deployment

To improve the setup of your WiFi, you should first record the activity in MaxHold calculator mode at several times of the day. This will give you a good understanding of which channels are busier.

In MaxHold mode, the highest level used by any channel is permanently recorded by a horizontal marker.

RF Explorer is a fully capable Spectrum Analyzer and, as such, will properly detect not only true 802.11 WiFi activity but also any other 2.4GHz signal that may create interference. This is a much better and more reliable method to finetune your WiFi setup than smartphone-based apps, which only detect 802.11 sources and channels, but ignore about any other interference. In many cases, non 802.11 interference are the main cause of low performance.

- If you identify powerful, permanent signal sources blocking specific channels, you should select the channels that are as far as possible from them.
- For 2.4GHz WiFi channels, the only non-overlapping channels are 1-6-11 therefore is suggested to setup your access points in one of the three of these channels were less activity is found through the day, including nearby channels (2 above and two below). For instance, you should select channel 6 if activity in channels 4-8 seem to be lower than 1-3 and 9-11.
- Except for high-end, professional access points, the "automatic" mode offered for channel selection is not good enough because is not usually able to monitor daily activity. The method described in previous steps is the most reliable procedure to improve a WiFi setup reliability and throughput.

Some examples depicted below:

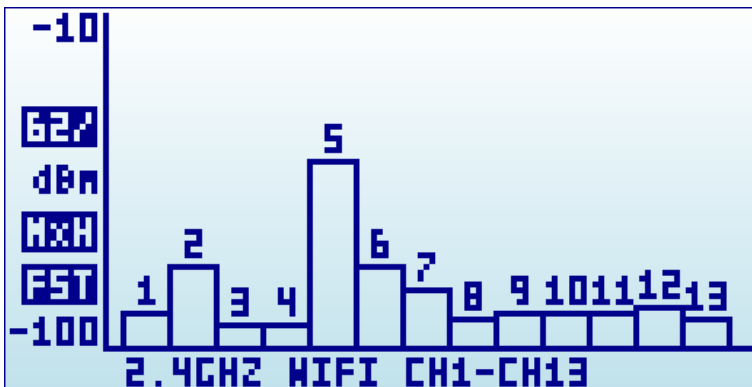

Channel 5 is clearly busy, we should discard using channel 6 whereas channel 11 seems a much better choice.

Channel 1 is not busy but nearby channel 2 is busy, therefore is not as good as a choice as channel 11.

Given the usually high noise level at 2.4GHz band, it is suggested to use a Bottom dBm of -100dBm or higher.

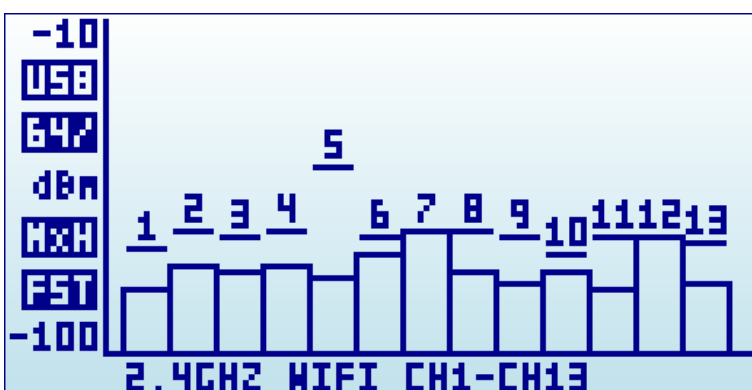

The same setup described before, but inspecting the activity for a longer time, shows the channel 5 is the one with higher level detected, so we confirm is not a good choice.

However, the difference among channel 1 and 11 is not that clear anymore, it seems both have equivalent activity over time.

Probably channel 11 is still a better choice

as it is farther away from channel 5.

Attenuator Menu

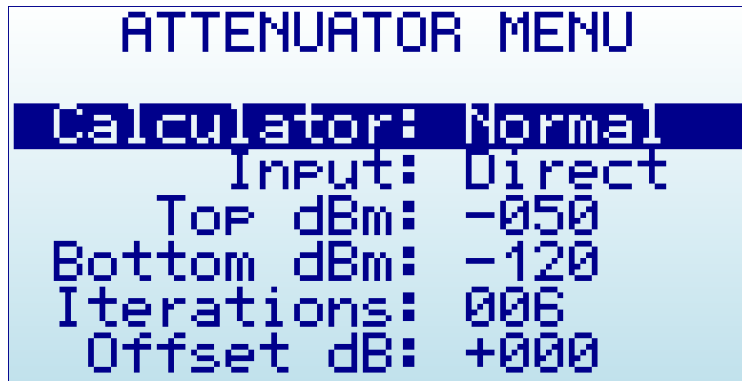

- **Calculator:** internal DSP calculator mode.
- **Input:** select input stage to enable LNA or Attenuator - *only in PLUS models*
- **Top dBm:** Visual max amplitude on screen.
- **Bottom dBm:** Visual min amplitude on screen.
- **Iterations:** Internal DSP calculator iterations.
- **Offset dB:** external dB attenuation or gain value to compensate for external devices, such as attenuators or amplifiers.
- **Units:** dBm or dBuV. *Note you may need to navigate all the way to the bottom for the menu to show this last option on screen.*

The selected Top and Bottom dBm are visual limits, not real internal limits.

The internal DSP optionally performs advanced calculations in order to configure the analyzer for the required measurement:

- **Calculator** offers multiple modes to display data, to change mode click on [Enter] key:
 - **Max:** Peak values are used from the last sweep Iterations (see menu option at the bottom). This is the standard mode you will want to use to detect rapidly changing DSS signals or find for worst case channel occupancy.
 - **Max Hold:** Capture all activity in the band including the Max signal envelope mode with vector graphics and real-time activity with vertical bars. Use this mode anytime you want to detect activity for a long period of time. It is a very powerful mode to detect activity in busy bands such as 2.4 GHz. As this is a cumulative mode, while on Spectrum Analyzer screen you can clear the spectrum anytime with the RETURN button.
 - **Average:** Arithmetic media average is calculated over the last sweep Iterations. This is the best possible choice to remove unwanted white noise from screen, particularly useful in constant wave (CW) and channel signals display.
 - **Normal:** No calculation is done, just raw data as result of the realtime sweep.
 - **Overwrite:** Useful to track unlimited activity in the band. Darker areas will point to high activity signal. You can clear the spectrum anytime with the RETURN button.
- **Iterations:** The number of sweep data iterations to perform calculations on. It goes from 1 to 16. As an example, a value of 5 with Calculator: Average means the DSP will use 5 complete accumulated sweeps to average data.

Note: *Selecting a higher or lower Top dBm value is a very frequent workflow, as you typically want to zoom in or out based on signal power being measured. RF Explorer Spectrum Analyzer main screen offers two keyboard shortcuts: [Up] and [Down] arrow keys can be used to increase or decrease Top dBm respectively*

by 5dBm each time. This shortcut, together with [Left] and [Right] for moving Center Frequency or Span as described before, are very convenient to make configuration changes real-time with no need to visit the Menu.

Included in RF Explorer Plus models is a selectable input stage with three possible signal paths:

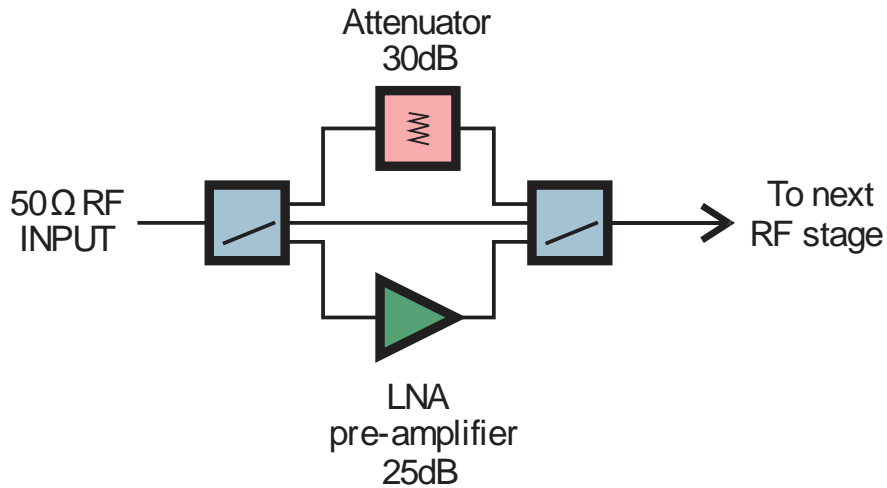

- **Direct:** low loss signal path to standard sensitivity, use for linear measurements up to -25dBm
- **Attenuator:** 30dB nominal wideband attenuator, use for linear measurement up to 0dBm
- **LNA:** low noise wideband preamplifier, use for linear measurements up to -40dBm. Note this option requires more battery power than other modes. When using LNA and an antenna, it is recommended using band pass filters to limit the wideband noise detected, otherwise degraded signal/noise reception may limit or even cancel the benefit of the amplifier.

The selection is defined by using the *Input* option in the *Attenuator Menu*. High performance RF switches drives signal path into the selected option instantly.

Configuration Menu



- **Backlight:** Several levels of display backlight. RF Explorer has good visibility indoor and outdoor, including direct sunlight. The level of backlight should be the appropriate for each condition, and you may want to limit backlight brightness to preserve battery capacity.
- **Contrast:** There are 10 different display contrast levels to choose from.
- **USB Bauds:** Default is 500Kbps, which is also the recommended setting. In the rare case you experience a problem when connecting with the PC, you may want to change this to 2400bps slower speed. However, this is not recommended as the connection will go really slow, so do this only if there is a good reason to. The port speed in the RF Explorer and PC Client settings must match to properly establish a connection.
- **Draw mode:** Vectors is the standard mode, and Fill can be specified if additional contrast is required by filling the area behind the signal.
- **Marker:** There are three different modes available for the Marker on the Spectrum Analyzer screen:
 - **Peak:** The marker will automatically detect the peak value on screen.
 - **Manual:** The marker can be manually moved anywhere on screen by using [Left] and [Right] buttons. When this mode is selected, the standard functions to move Center Frequency or Span are disabled.
 - **None:** The marker is not displayed.
- **DSP:** The DSP (Digital Signal Processor) can be configured in different ways in order to select the best possible choice of noise reduction, image rejection and scan speed.
 - **Auto:** This is the recommended option for all users. When Auto mode is enabled, the internal configuration tables will select the best possible algorithm. The Spectrum Analyzer screen will display a FIR (Filter) or FST (Fast) mode to indicate the actual DSP mode being used.
 - **Filter:** This mode is currently functional in the 15-2700MHz module and Plus models only, but other modules may implement it in the future. When Filter mode is enabled, the DSP will scan the spectrum several times in order to reject unwanted spurs and image frequency out of the screen. As result of that, the scan speed is slower than compared with Fast mode.
 - **Fast:** This mode is recommended for advanced users only. When it is selected on the 15-2700MHz or Plus module, the DSP will not process spurs and therefore unwanted signals may display on screen.

Preset Menu



Preset is a convenient facility to store multiple configurations which can be easily recovered. This feature is supported in selected models only: RF Explorer Combo models (since firmware v1.26) and RF Explorer Plus models.

- **Identifier:** Numerical index of the preset valid from 1-100 (Plus model) or 1-30 (Combo models)
- **Description:** Descriptive text up to 12 characters long. An asterisk at the end is automatically added when the preset has actually some data stored. In Plus model, this field is editable and can be changed in the device. In Combo models, this field is read only and can only be updated with the external Preset Manager tool.
- **Load:** Action option to load stored preset values into current configuration, the menu screen is automatically closed
- **Save:** Action option to save current configuration into the selected preset – this option cannot be undone, care should be taken to not overwrite another valid preset
- **Reset:** Action option to remove all values from selected preset and reset to unused state - this option cannot be undone, care should be taken to not reset a valid preset
- **Frequency range:** when an active preset with data stored is selected, the last line of the screen shows the Start/Stop frequency range of the preset, to help on determining the specific preset configuration before using it. This line will be blank when an empty preset is selected.

Easy Preset restore:

This menu has a very convenient shortcut for easy selection and restore of any pre-defined preset:

- **Plus models:** press SET button from any *Analyzer* mode screen. By pressing SET button, this menu becomes active and cursor is preselected in *Load* action option. Pressing SET button inside this menu will iterate through all predefined Presets with valid data one by one. This shortcut is faster than manually changing *Identifier* numbers one by one when you are looking to load a preset.
- **Combo models:** These models do not have a dedicated SET button, but an equivalent function is available by clicking ENTER button on *Desc:* line, the menu will iterate through all predefined Presets with valid data one by one. This shortcut is faster than manually changing *Identifier* numbers one by one when you are looking to load a preset.

Using RF Explorer Preset Manager

This is an included convenient tool to easily create and edit Presets from a Windows, Linux or Mac computer. It also includes the ability to define custom Description text for each preset.

Presets can be uploaded to / downloaded from the RF Explorer device using USB standard connection, and presets definitions can be imported / exported to share definition among devices easily.

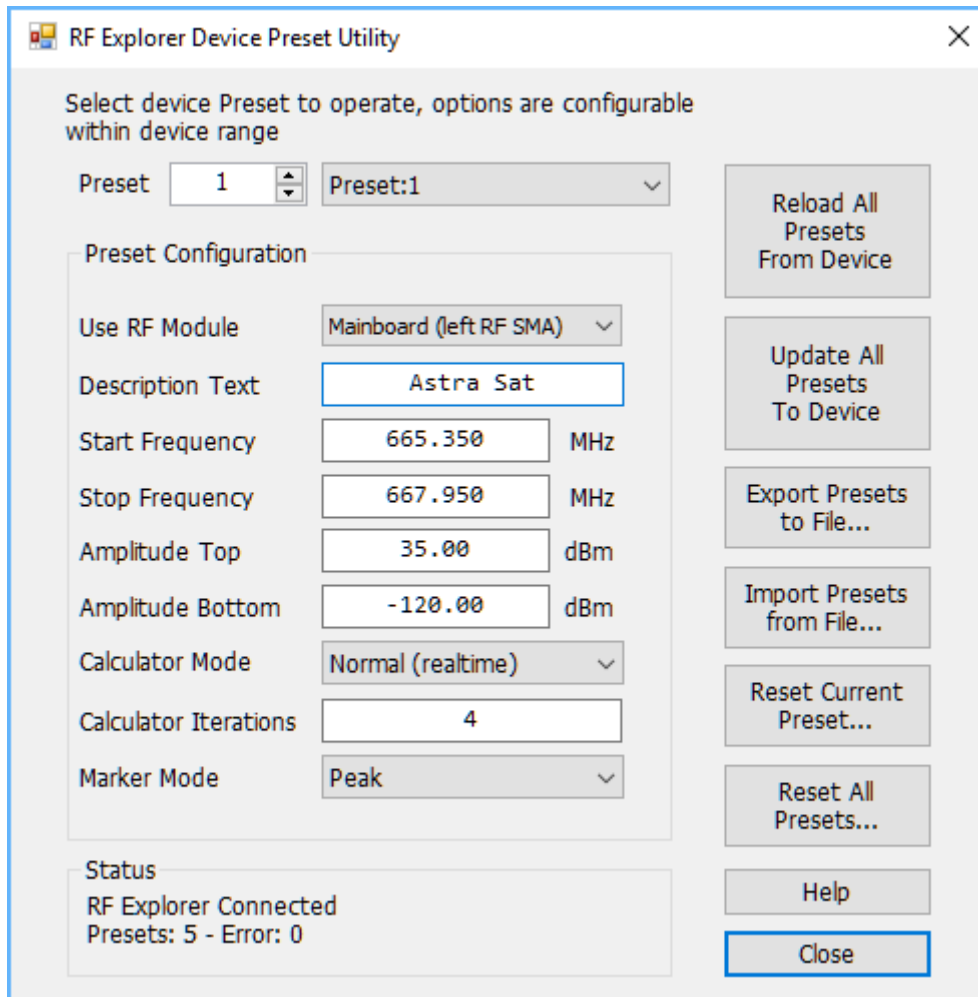

For more details please visit online help:

www.rf-explorer.com/preset

Record / Play MENU (PLUS model only)

Starting with firmware v3.18, all RF Explorer PLUS models can record and replay stored sweeps. This feature is useful for working on the field where a computer cannot be easily connected to the Spectrum Analyzer, or any other situation where signal activity needs to be stored in the device for future study, replay or reference.

Sweeps can be captured in multiple record sessions. Each session may have up to 250 sweeps normally, or up to 999 sweeps if required.

Up to 100 different record sessions can be stored, each session has a record session ID and an optional description. A total of up to 8000 sweeps can be stored in the internal device memory, regardless on how many sessions are these sweeps distributed.

Sweeps and record sessions are stored in permanent FLASH memory and therefore can be replayed even after the spectrum analyzer gets powered down. Memory space can be restored by deleting all record sessions.



- **Identifier:** Numerical index of the record session valid from 1-100 (or N/A when no record session is currently stored)
- **Description:** Descriptive text up to 8 characters long (or N/A when no record session is currently stored). This text can be edited by click on ENTER and then using UP/DOWN keys for each character.
- **Total Sweeps:** Indicates the number of sweeps stored in a record session, but can be edited to indicate the predefined number of sweeps to record in a new record session. By entering positive values up to 250 you indicate how many records will be stored before the session is automatically stopped. Alternatively, entering 000 will allow up to 999 sweeps to be stored.
- **Rec Interval:** The record interval (1-100) indicates the number of realtime sweeps vs stored sweeps ratio. For instance, an interval of 3 will indicate one sweep is stored for each three actual sweeps in realtime. This is a useful and effective way to limit the storage size if you need to capture activity for long periods of time.



- **Record:** Action option to start a record session. This requires the device to be in spectrum analyzer mode, it will not work in WiFi Analyzer or other modes.
- **Replay:** Action option to replay a recorded session.
- **Delete All:** Action option to delete all recorded sessions and make new room for future records. Some options like this one may only be visible if you navigate the menu down.

How to record sweeps

1. Set the Spectrum Analyzer in the correct frequency configuration, once the record session starts the analyzer configuration cannot be changed for as long as sweeps are being recorded.
2. Go to the REC/PLAY MENU and edit values for **Total Sweeps** and **Rec Interval**. The currently selected record session is irrelevant, only these two parameters are significant for a new record session.
3. Click ENTER on **Record** option.
4. Recording will start immediately. The screen will show a **RECORD** text at the bottom and will show a counter of the currently stored sweep.
5. Once the total number of sweeps are recorded, the record mode will stop automatically. The record mode can be stopped manually at any time by clicking on any key.

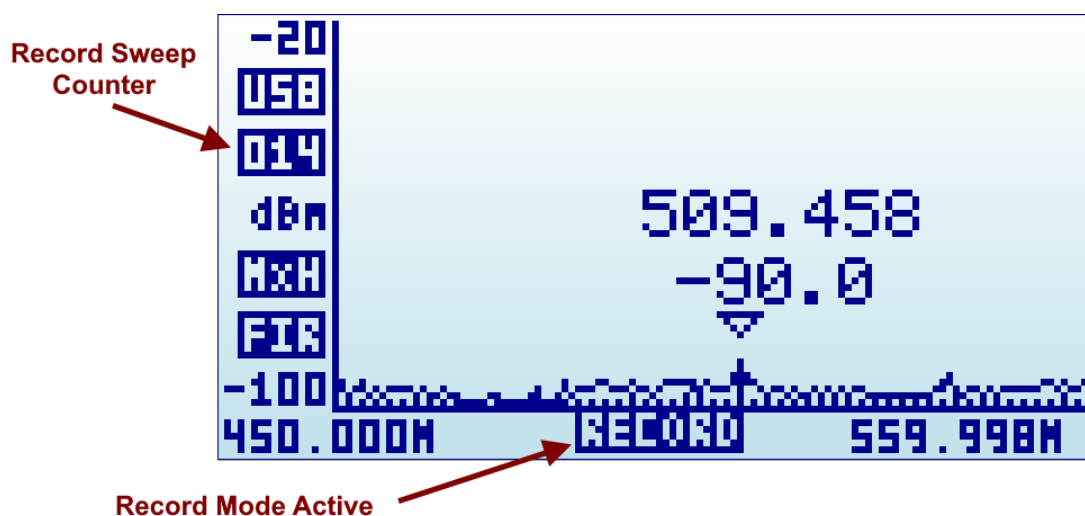

How to replay stored sweeps

1. Go to the REC/PLAY MENU and click ENTER on Replay option
2. Replay screen will start immediately. The screen will show a **REPLAY** text at the bottom and will show a counter of the currently stored sweep.
3. Once the total number of sweeps are replayed, the replay mode will stop automatically. The replay mode can be stopped manually at any time by clicking on any key.
4. Once the replay mode ends, it keeps the analyzer on hold on the last recorded sweep for that session.
5. Sweeps are displayed at a speed of 2 per second, regardless of the actual speed at which they were recorded.

Beep sounds

Each time a record session starts or stop, a double beep will sound to advertise the action.

Similarly, each time a session is replayed, a triple beep will sound when starts and stops.

The beep sound is only active when the device is working on battery mode (power switch in ON position).

Registering License

The Record/Play mode requires a license. Full details to order this license online and register for your device are available at

www.rf-explorer.com/rec

Enabled licenses on a specific device are listed on the About screen.

Future enhancements

Upcoming firmware upgrade may introduce enhancements at no extra cost for license owners:

- Adjustable replay speed
- Storage of recorded sessions as data files on a computer
- Selectable sessions to delete – currently all sessions are deleted at once
- Function to replay manually each sweep by using LEFT and RIGHT keys
- Automatic storage based on a threshold
- Sound beep selectable ON/OFF

HAM Field Meter (PLUS models only)

Starting with firmware v3.25, all RF Explorer PLUS models can perform specific W/m² or V/m measurements for all sub-GHz popular HAM frequency bands. This feature is developed with contributions from Martin Lynch & Sons (www.hamradio.co.uk)

You can use this feature to convert RF Explorer Spectrum Analyzer into an effective, accurate and easy to use Field Meter to easily check power levels being transmitted by your antenna at a reference distance, and check if transmission levels are in compliance with local regulations.

Note: for accurate measurement you need to apply specific antenna and compensate with Offset dB parameter to adjust for antenna gain. Multi band highly accurate, calibrated antennas are normally used by EMC testing and cost thousands of dollars, which is not a cost-effective approach for a handheld device. Therefore, we provide full support for the included dual band 144/430MHz telescopic antenna with gain adjustment for each band. Other 50 ohm antennas can be used by adjusting offset gain accordingly.

To select the new mode, click on HAM Field Meter option (not available if the currently selected module is the 2400MHz module, select the 50KHz-940MHz module for this mode to become available)



Frequency bands currently supported are depicted below

Frequency Band (MHz)	HAM definition	Suggested Antenna Gain Offset (dB)
3.500 - 4.000	80 meters	TBD
5.000 - 5.400	60 meters	TBD
7.000 - 7.300	40 meters	TBD
10.100 - 10.150	30 meters	TBD
14.000 - 14.350	20 meters	TBD
18.068 - 18.168	17 meters	TBD
21.000 - 21.450	15 meters	TBD
24.890 - 24.990	12 meters	TBD
28.000 - 29.700	10 meters	TBD
50.000 - 54.000	6 meters	TBD
70.000 - 70.500	4 meters	TBD
144.000 - 148.000	2 meters	0
420.000 - 450.000	70 centimeters	0

Registering License

The Record/Play mode requires a license. Full details to order this license online and register for your device are available at

www.rf-explorer.com/ham

Enabled licenses on a specific device are listed on the About screen.

How to measure field strength

By selecting the HAM Field Meter the following screen will display

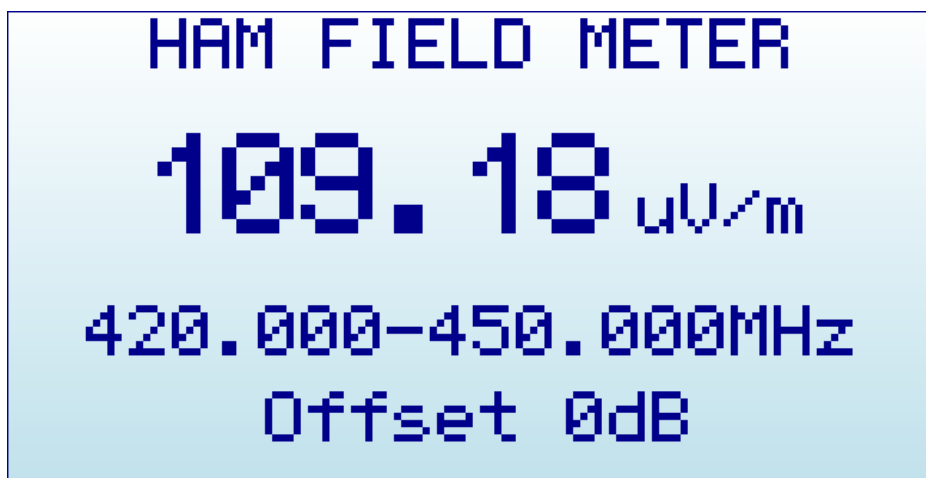

The value can be displayed in V/m or W/m² depending on user choice.

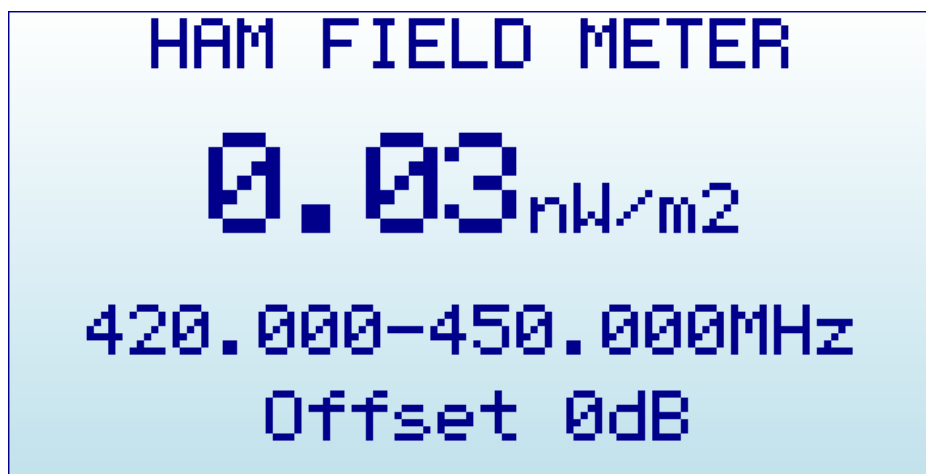

Measurement values are automatically scaled and adjusted to pico/nano/micro/milli for convenient screen reading.

Buttons functions are specific of this mode:

- Press button SET to switch between V/m and W/m²
- Press button HELP to get context information
- Press button ENTER to enable/disable HOLD mode
- Press buttons LEFT/RIGHT to change to higher/lower frequency band
- Press buttons UP/DOWN to increase/decrease Offset in dB. This is equivalent to ATTENUATOR MENU option OffsetDB but is added on this screen for convenience adjusting specific antenna gain on each band.
- Press button MENU to select other configurations and operational modes

HELP button (Plus model only)

RF Explorer WSUB1G Plus model includes HELP button for easy, intuitive context-sensitive help.

The HELP text can be displayed in all functional screens, effectively complementing this User Manual with handy information, always available with a simple click.

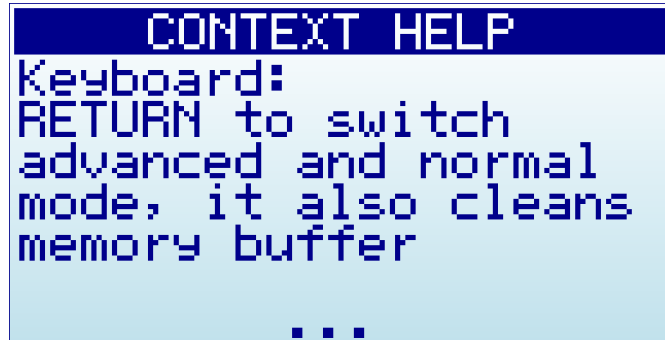

Use the following keys to interact with Help screen:

- **Scroll text up and down:** The bottom of screen shows "..." when additional text is available for scroll. Use UP and DOWN arrow key buttons to scroll text one line at a time, or LEFT and RIGHT arrow key buttons to scroll text full page at a time.
- **Help on Help:** This special screen offers description of how to interact with Help screen itself. Use HELP button within a Help screen to activate *Help on Help*.

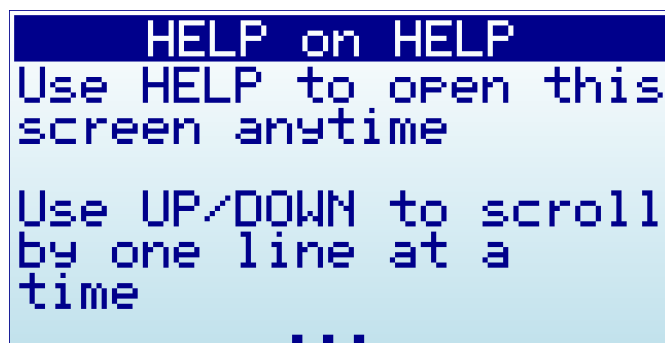

- **Close help screen:** use RETURN or ENTER key, both will close the help screen and return to previous device state.

RF Generator mode

Some RF Explorer models can generate a CW RF tone or a configurable sweep for testing RF receivers and simulating interference very easily.

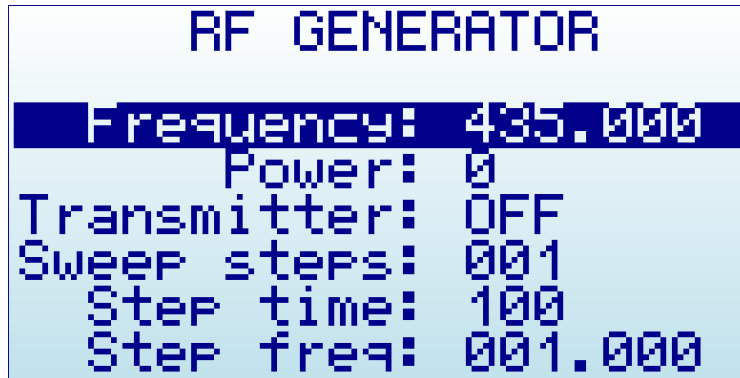

- **Frequency:** Transmit frequency in MHZ in single tone mode, or start frequency in MHZ in sweep mode.
- **Power:** Transmit power in dBm, increasingly changed by 3dB steps each time [Enter] key is pressed. Accuracy is typically +-3dB and can be significantly influenced by the matching load. Pure 50 ohm loads will give better results than loads with some high VSWR values due to impedance unmatched, for instance an antenna not tuned for the transmit frequency.
- **Transmitter:** Switch to ON to start transmitter, to OFF will stop the transmitter. It is important to switch the transmitter to ON only when a load is connected.
- **Sweep steps:**
 - When defined to 1, the RF Generator will work in **single tone mode**. In this mode it will permanently transmit a CW on the frequency specified.
 - When defined to any value from 2 to 255, the RF Generator will work in **sweep mode**. In this mode it will transmit a tone starting on the frequency specified, and then will hop to a frequency value that is *Step freq* MHZ higher, lasting *Step time* milliseconds, till it reach the number of steps. After the last programmed frequency is transmitted it will go back to the first frequency, repeating the cycle till the transmitter is set to OFF by the user.
- **Step time:** Defines the milliseconds to transmit each tone before the next hop. Valid range is 5-255ms. Used in sweep mode only.
- **Step freq:** Defines the incremental frequency of each hop in the sweep. Valid ranges goes from 0.010 to 2.55 MHz. Used in sweep mode only.

To return to Spectrum Analyzer from RF Generator, use [Menu] button and select Spectrum Analyzer in the OPERATIONAL MENU.

IMPORTANT

You must have connected a 50 ohm antenna or RF load before you switch your transmitter ON.

If you switch the transmitter ON without a proper antenna, you may damage the RF module of your RF Explorer, as the power amplifier will not have a load to feed. Think of the equivalent to an audio amplifier running at full power with no speakers connected: you are likely damaging the power transistors.

You can use any kind of RF 50 ohm load, including a dummy load, a coaxial with a 50 ohm termination, etc. If you use a load different than 50 ohm, the reflected wave may also damage the power amplifier.

Except you need full power for a range test, we suggest always use the lowest power level to minimize battery consumption and EMI radiation. Note local regulations must be observed, so double check you are not radiating a tone with power or frequency that may interfere with other equipment.

The RF Generator is limited to the same frequency band than the Spectrum Analyzer; therefore you can transmit any frequency of choice in the specific band of your model. In some cases, the sweep steps or the sweep frequency will be limited to a lower value than you may expect: this is because the combination of start frequency, step and number of steps must fit into the available range in all cases.

RF Explorer internal battery

The internal battery is a high capacity Lithium-ion polymer 1000mAh. This is the same battery technology used in cell phones and modern laptops and tablet computers.

The power switch is a *true hard switch* connecting the battery in ON position, fully isolating the battery in the OFF position. As the battery is fully disconnected in the OFF position, you can keep your RF Explorer stored for months and the battery will keep the charge intact, as opposed to cell phones or laptops which typically implement a *soft switch* which slowly discharge the battery by drawing a microamperes continuously from it. This doesn't happen in your RF Explorer.

We designed RF Explorer power circuitry in a way you can always have your RF Explorer ready to use!

Note there is actually a self-discharge effect in the battery but it is so negligible that you can store your device for a year or more and a battery will not be depleted.

IMPORTANT

Never charge your device unattended or in any place where there is a risk of fire.

Never store RF Explorer in a place where temperature may go beyond 50°C (122F).

A car can heat up incredibly quickly in the *SUN*, especially in the summer, and damage or reduce the lifetime of your battery if stored in such an environment.

If you manipulate RF Explorer to assemble an Expansion Module, always proceed very carefully with the Lithium Ion battery and make sure it is not punctured, damaged or inflated in any way. A healthy battery is a flat rectangle with no signs of any deformation. If you have any doubt, please take a picture of your unit and send it to us for further help.

If your battery doesn't seem to hold a charge or work properly, or if the unit gets hot when charging, switch the power button OFF immediately and review and/or replace your battery.

Never use RF Explorer with a damaged battery or with a Lithium Ion battery different than the one officially supplied by technical service, which includes a protection circuit for safety. Contact QC@SeeedStudio.com if you have any question on any matter related with your battery or if you need a replacement.

Charging the internal battery

To charge the internal battery, plug it in to a powered USB port or USB wall-wart charger via the USB mini socket. For the internal charger to access the battery, you must set the power switch to ON position, otherwise the device will be running from USB but will not use or charge the internal battery.

RF Explorer may draw up to 500mA according to USB standard, and may take up to 3hs max to charge a fully discharged battery in normal conditions. We recommend the first time to be charged for up to 8hs.

It is ok having the battery connected forever to the USB port, the internal charger will stop and start the charge when needed.

If your USB port is unpowered it may not be capable of delivering more than 100mA; the battery may not be charged at all. If you have no other option available than a 100mA USB port, set the LCD backlight to OFF in the OPTIONS MENU and keep charging for as long as needed (it may take up to 24hs in these conditions so you should use a powered USB port whenever possible).

Using the Battery dedicated screen

In latest firmware versions, you can use the specific Battery menu option for better battery charge control. Note: As long as the USB is connected and the power switch is in the ON position, the battery will charge. However, you can get additional information when using the Battery specific menu.



Inside this INTERNAL BATTERY charger screen, it is easier to realize if the battery is being charged. In this case below, it clearly indicates the power switch is not in the ON position and, therefore, battery is not being charged.

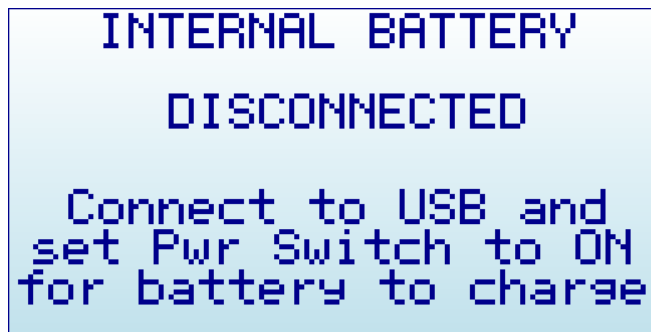

As soon as the power switch is set to the correct position, the screen will display correct charging status.

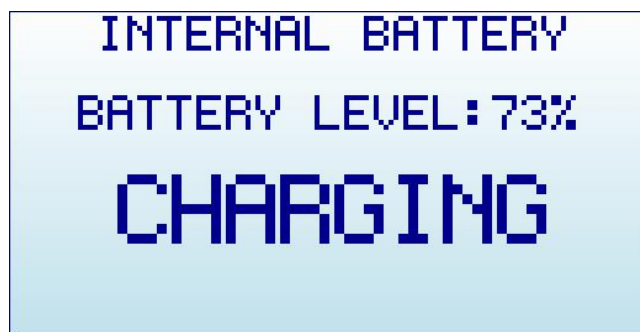

At this point you can close this screen pressing ENTER or RETURN. If you keep it active for more than 15 seconds, it automatically sets the device in SLEEP MODE - all internal circuits and LCD backlight go off, except for charging and minimal CPU monitoring - This is the recommended procedure to charge the device

overnight. Note: for the sake of clarity, below black/white screen images are depicted when LCD backlight is OFF.

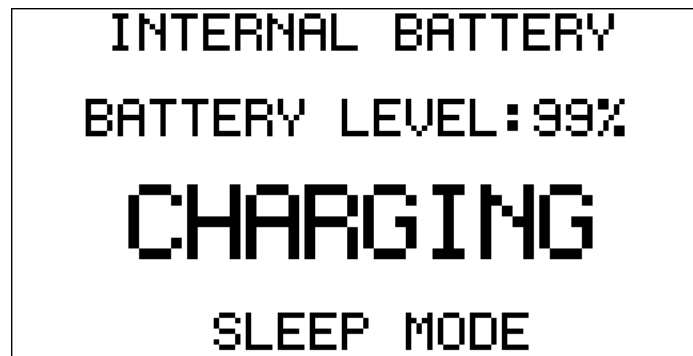

In this mode you can stop charging whenever the device reaches 99% or 100%, which may take up to 2 or 3 hours under normal condition and depending on initial battery charge level. When the charging algorithm detects the battery fully charged and a minimum of 2hs connected, it will suggest disconnecting the USB cable.

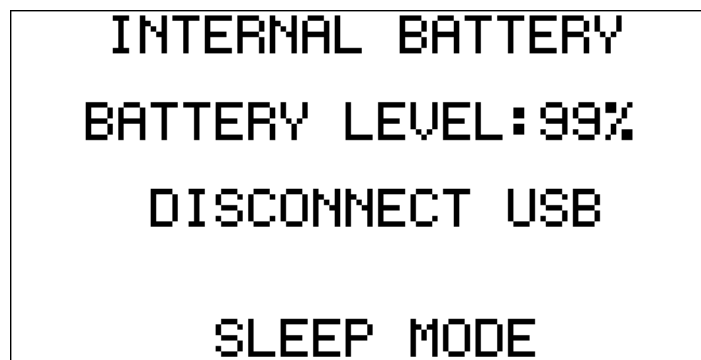

Calibrating the battery capacity

The INTERNAL BATTERY screen, at this point, can re-calibrate the available battery power level. This is a useful feature to adjust what reference voltage the internal charger considers 100% capacity. This reference is subject to change over time as the internal battery reduces total capacity over many charge cycles. As a reference, 500 charge cycles will typically reduce the total battery capacity about 30% - in order for this new capacity to be consistent with the battery icon on screen, you can easily recalibrate after the charge process completed.

In the previous example screen, if the battery charge remains at 99% (or any other level) after the internal charger timer completes 3hs charge process, it will keep asking to DISCONNECT USB.

By doing so, the firmware adjust for a few seconds the new charge level and save in internal ROM for future use.



After the device recalibrates the internal battery charge reference level, it will automatically restart and you should see the Battery icon (on Spectrum Analyzer screen) showing full charge.

Charging a fully depleted battery

The firmware includes a protection mechanism to shutdown everything if the battery goes too low, in the range of 3.3V or less. However, this state will still keep drawing about 1mA from the battery. If you keep the power switch to ON forever the battery will be depleted but limited to a safe 3V level where battery protection circuitry will reduce the leakage to about 50uA.

In any case, the internal battery charger will take care of the battery conditions once it gets powered back from the USB and will charge the battery using an internal efficient algorithm. For that to work properly when the battery was fully depleted, you should use the Battery menu option as described.

Automatic idle mode with battery charge

As described in previous section, you should enable the Battery screen and keep it charging for the device to automatically set internal circuits to Sleep for overnight charge.

Note: A more limited, equivalent functionality was available in old firmware versions prior to v1.16 in the About screen, it has now moved to the new Battery screen. The About screen no longer sets the device to sleep.

Expansion Modules

RF Explorer includes an internal expansion port to enhance the capabilities and frequency coverage of the main unit with RF Explorer compatible Expansion Modules.

To learn more about different expansion options available for your unit, please visit

www.rf-explorer.com/models

Assembling an expansion module is very easy task; see step by step details at

www.rf-explorer.com/expansion

Once installed, an expansion module adds RAM and ROM memory to the unit, as well as RF additional coverage in an extra SMA RF port on the right side.

SMA left connector is always the main unit connector, whereas the SMA connector on the right is always the expansion module connector. The installed capabilities are displayed on the RF Connections entry in the Operational Mode menu.

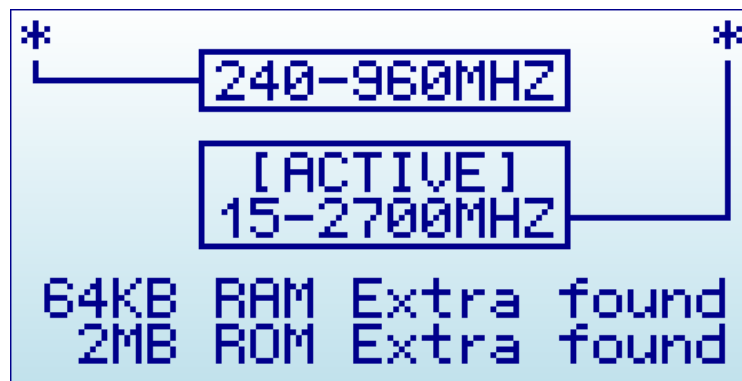

Important: Only one of the two SMA connectors is enabled at any given time. You select the active one using the Module option in the Frequency Menu, see page 16.

Note: Extra RAM and ROM are always available for the internal functionality, regardless the active connector selected.

RF Explorer antennas

Antennas are a very important accessory to properly detect signals with the best sensitivity in a given frequency range. Using an incorrect antenna will result in poor, usually very low signal detection or no detection at all.

The included antennas are suited for most popular frequency bands, but do not have full coverage of all possible frequency ranges. The user must order separated antennas for additional frequency ranges, if that is required, for proper operation. RF Explorer is compatible with any 50-ohm standard antenna of any shape, size or application.

Telescopic dual band 144/430MHz

This is a telescopic, high quality 2dBi antenna ideally suited for 144MHz and 430MHz bands, typically used in two-way radios and HAM bands.



It offers a good response in all frequencies below 1GHz. Use this antenna in all ranges of frequencies between 15-1000MHz. In some cases, collapsing partially or totally may provide better response in the highest frequencies of the range.

The metallic structure of the antenna is a direct connection to the core RF connection, therefore take precautions for the antenna not being in contact with strong electric fields or DC current.

This antenna is included in all RF Explorer PLUS models, as well as RF Explorer WSUB1G, RF Explorer 3G and 6G Combo and RF Explorer ISM Combo.

For more details and ordering [visit this link](#).

UHF 400-900MHz antenna

It is ideal choice for Pro Audio and Video professionals. This antenna is included with all RF Explorer PLUS models.

The RF Explorer UHF antenna is a high performance, custom made robust rubber duck model for 400-900MHz range. It covers all TV and Digital TV Broadcast (DTVB) and the range used for all UHF Wireless Microphones from major brands.

This antenna is recommended for RF Explorer for best reception and sensitivity in UHF range.

For more details and ordering [visit this link](#).



Whip dipole antennas

These are quality 2dBi antennas designed for narrow band application.



Different RF Explorer models include different antennas; they may look exactly the same externally but are internally tuned to a specific band and should be ideally used on that band only.

The core RF connection is enclosed in a plastic case, therefore protected from external electrical contact.

RF Explorer 2.4G/PLUS and ISM COMBO/PLUS: includes a 2dBi antenna tuned for 2450MHz

For more details and ordering [visit this link](#).

Rubber duck 5.8GHz antenna

This is a quality antenna with good coverage in the range of 5.4-5.9GHz, specifically WIFI channels.

It offers reasonable coverage in the 2.4 Ghz band too, so can be used as dual band antenna for WiFi.

This antenna is included in RF Explorer 6G Combo/PLUS.

For more details and ordering [visit this link](#).



Additional antennas

As a general purpose RF Spectrum Analyzer, RF Explorer can be used to measure and diagnose different frequency bands. For physical reasons, there is no antenna design which can effectively work at all possible frequencies, therefore we provide additional antenna choices based on required band.

Any 50ohm antenna can be connected to RF Explorer, but we selected, tested and validated a few convenient quality antennas as listed below.

LTE antenna



The omnidirectional LTE multiband antenna is designed for worldwide LTE / 4G cell reception, and can be used for other purposes in the supported frequency range of Frequency: 698-960 / 1710-2170 / 2500-2700 MHz.

It comes in a compact, robust articulated lightweight design, making it an ideal choice for handheld RF Explorer Spectrum Analyzer.

For more details and ordering [visit this link](#).

Cloverleaf dual band 2.4 / 5.8Ghz omnidirectional

The CloverLeaf omnidirectional antenna is the perfect choice to use RF Explorer in 2.4Ghz and 5.8GHz bands.

CloverLeaf antennas have circular polarization and therefore can detect all direct and bouncing signals, making a way superior choice to detect interference and wanted radiations.

The main difference with other dual band antennas is the perfect coverage in all directions, as opposed to whip and rubber duck dipoles which are limited to vertically polarized signals.

It comes with standard SMA connector and robust ABS coverage to protect internal Cloverleaf multi-petal design from damage.

For more details and ordering [visit this link](#).



Directional Patch SMA Articulated Antenna, versions for 5.8Ghz and 2.4Ghz



The directional patch antenna is a high gain, excellent choice to use RF Explorer analyzer to scan in a specific direction. As opposed to omnidirectional antennas such as dipole type, this patch antenna has an 8dBi gain in the front face. It includes a true SMA connector (not RP-SMA as most in the market) and therefore fits perfectly in all RF Explorer models.

This antenna is suggested for high sensitivity detection of RF sources with RF Explorer Spectrum Analyzer, including distant transmitters, focus and orientate antennas or find nearby hidden bug devices. It is also perfect to find your lost drone or RC plane as long as still transmit valid signal.

For more details and ordering 2.4Ghz version [visit this link](#).

For more details and ordering 5.8Ghz version [visit this link](#).

RF Explorer Near Field antennas

The RF Explorer Near Field Antenna Kit is a set of 4 high performance antennas designed for the most demanding RF diagnosis tasks:

- RFEAH-25 – H-Loop magnetic 25mm diameter
- RFEAH-15 – H-Loop magnetic 15mm diameter
- RFEAH-5 – H-Loop magnetic 5mm diameter
- RFEAE-10 – E-Field stub 10mm length



The low loss design of these antennas exhibits at least 10dB more sensitivity than other near field antennas in the market, at a much lower cost.

Compared with other near field antennas, RF Explorer are smaller and lighter, exactly what fits best when space is constrained in a PCB.

A brief description of the kit is included below. For further details and datasheet, please visit [dedicated site link](#).

Included with the antenna is high quality semi-flexible RF cable, this cable works as the handler of the antenna.

The big advantage of this approach: you can shape the cable the way you want for the antenna to be located exactly where you need it, in most cases with no need to hold it in your hand.

Nevertheless, in many cases you need a quick measurement done in a unique orientation or location, just use the semi-rigid cable has the holder of the antenna.

You can also connect this semi-rigid cable to any external SMA Cable of any additional length to couple it to a distant instrument.

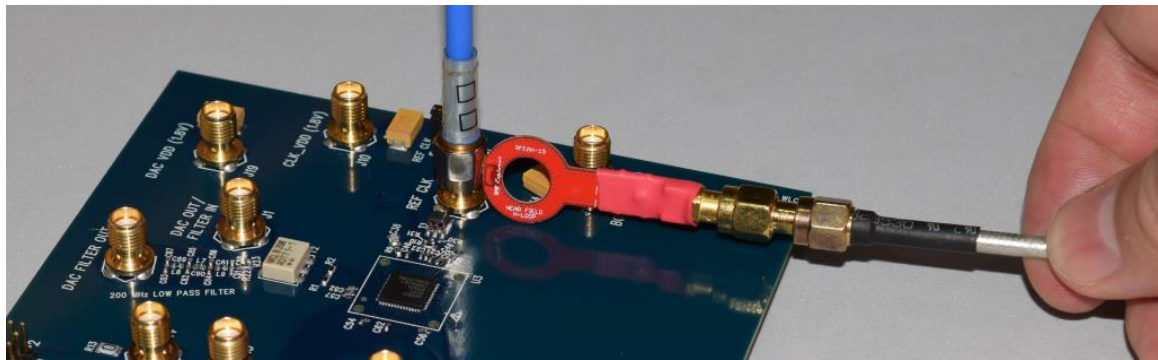
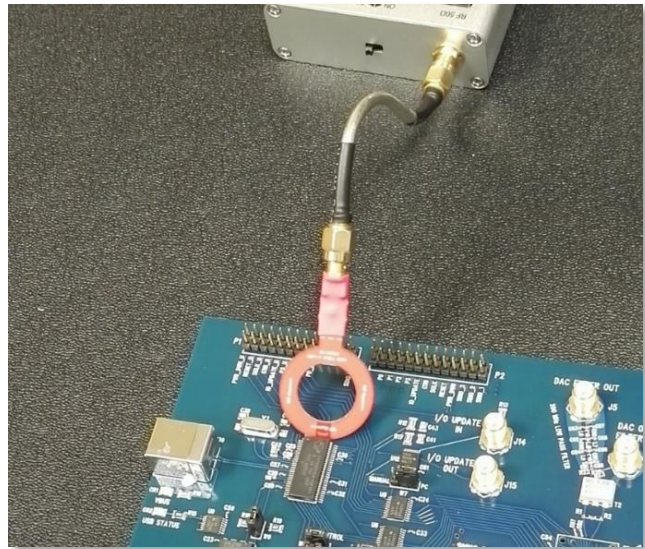

Magnetic H-Loop antennas

There are three different magnetic antenna options: As the antenna diameter gets shorter, the spatial resolution increases at the cost of some sensitivity loss at low frequencies, but best response at high frequencies; you should select RFEAH-25 for best sensitivity with connectors, large ICs and isolated signal traces, whereas RFEAH-5 works best for very narrow selective work in a populated PCB with close-by signal traces. RFEAH-15 is a good in-between compromise.

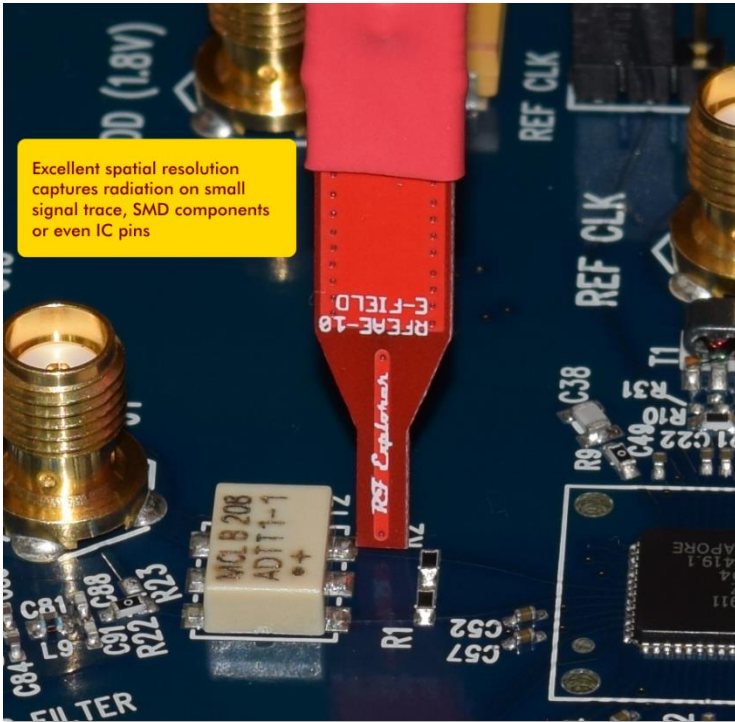

Stub E-Field antenna

The electric field RFEAE-10 stub offers a remarkable spatial resolution to determine the exact component in the PCB causing a problem, no matter how small it is.

You can easily determine signal level at the input and output of a filter, amplifier, mixer, etc in a tight SMD assembly as picture below.

Protecting your instrument from damage

RF Explorer is a very sensitive device. It can detect signals as low as -120dBm, which is 10E-12mW or 9nA over a 50ohm load.

This extreme sensitivity comes at the price of some fragility; your device needs care handling and protection in order to run for many years without problems.

Most RF technicians know the RF instruments have to be protected in order to survive the high Electro Magnetic (EM) fields that may be in the environment.

Even expensive \$50,000 full sized Spectrum Analyzers and Signal Analyzers for bench labs comes with a long list of handling procedures the operator must observe in order to limit any chance of damage.

The first and most obvious precaution is to make sure the input RF power is not beyond the acceptable levels of the instrument. Below are listed max tolerable input power levels, beyond these values the instrument may get permanent damage or decreased sensitivity.

RF Explorer model	Max power input (left SMA)	Max power input (right SMA)
3G Combo	+5dBm	+30dBm
6G Combo	+25dBm	+30dBm
ISM Combo	+5dBm	+5dBm
WiFi Combo	+25dBm	+5dBm
6G	+25dBm	n/a
2.4G	+5dBm	n/a
WSUB1G	+5dBm	n/a
WSUB1G PLUS	+30dBm using internal attenuator +10dBm direct mode -20dBm LNA mode	n/a
6G Combo PLUS 4G Combo PLUS	+30dBm using internal attenuator +10dBm direct mode -20dBm LNA mode	
433M/868M/915M	+10dBm	n/a

Note: these are max input levels to avoid damage, not actually measurable levels. As a general indication keep power levels at least 20dB below these threshold levels to avoid measurement distortion.

You can easily extend these input power ranges by using external attenuators (see section *External Attenuators* in page 49), and/or Power Limiter (see section *RF Explorer Power Limiter* in page 51).

RF Explorer 3G Combo, 6G Combo and RFEMWSUB3G models and all PLUS models with internal attenuator enable are well protected up to +30dBm (1Watt) input power, which is plenty to play safe in pretty much any environment. No extra external protection is usually needed for these models if operated correctly.

However, other RF Explorer models such as 2.4G or WSUB1G have a maximum safe input power of +5dBm, which is 3mW in the RF SMA port. As a reference, that is the power captured by the RF antenna from a cell phone a distance of 10cm, or from a Microwave oven at about 1 meter distance. Not all the ovens or cell phones work the same, so take this as an indication only.

What may not be obvious to all users is this is a limit in **any RF frequency band, even if the RF Explorer is powered off.**

As an example, the RF Explorer WSUB1G -with a frequency range of 240-960MHz- will not detect a microwave oven (2.4GHz) on the screen but can be very well damaged by it. Similarly, a strong 2m HAM or FM high power transmit station won't be detected by this model, but still induces enough RF power to kill the RF circuitry with ease. And that doesn't depend on RF Explorer being ON or OFF because the antenna will receive that powerful signal and will inject it into the spectrum analyzer, with serious risk of damage.



In addition to RF power, you should reduce the likelihood of static discharge over the antenna. In particular, the naked metallic antennas such as the Nagoya telescopic antenna we include in the wideband models. The whip helical plastic antennas included in the narrow band models do not expose the internal contact to the outside world and thus are safer from [ESD](#)³ perspective because don't offer a direct current path to the internal sensitive CMOS component pin, but all metallic antennas needs you to observe good ESD practices, most importantly in very dry winter air: Make sure you have a good hand contact with the metal case of the RF Explorer before touching the antenna and, whenever possible, do not touch the antenna with your hands.

For this very same reason, you should never make contact with the antenna to any external energy source. Just imagine what power can be injected inside if you make the antenna contact to AC current or a powerful AC source of any kind!

³ http://en.wikipedia.org/wiki/Electrostatic_sensitive_device

External Attenuators

SMA attenuators are used to reduce the input power, and therefore enable RF Explorer to measure stronger signals. It is also used to protect the input SMA port of RF Explorer when unknown strong signals may be in the environment, so you can use this attenuator on demand. You can easily unplug the attenuator when measurement is for weak signals.

You can also combine multiple attenuators to get additional values. For instance a 10 dB + 30dB attenuators connected in series will give you 40dB total attenuation.

RF Explorer firmware includes an "Offset DB" feature in the Attenuator Menu, you should specify +0XX dB (where XX is the attenuation value, e.g. 30dB) in this setting when the attenuator is connected in order to get correct readings on screen.

Attenuators recommended by us are high precision mechanical and electrical, working reliably up to 6GHz and supporting continuous input power of up to 2Watt (33dBm). We do not recommend low quality or second hand attenuators as they may alter amplitude readings and, in worse case low quality SMA mechanical connectors, even damage your analyzer RF SMA ports.

Based on total input power you may need to measure, we recommend the following attenuator values to be added to RF Explorer Spectrum Analyzer input port:

Measurable input range	Recommended external attenuator
Lower than -30dBm / 1 micro Watt	No need
-30 to 0dBm / 1 microWatt to 1 milliWatt	30dB
-30 to 10dBm / 1 microWatt to 10 milliWatt	40dB
0 to 33dBm / 1 milliWatt to 2 Watt	60dB

6GHz SMA Attenuator – 60dB



This robust attenuator is custom made, high quality exceptional value 60dB total attenuation. You will not find attenuators of this range anywhere else in the market, the only other option is to daisy chain two 30dB attenuators together.

Therefore, this unit is cost effective option to measure high power RF signals. A 60dB attenuation enables any RF Explorer unit to measure signals of up to 2Watt (33dBm) power without distortion with a single attenuator, as opposed to connecting multiple attenuators in daisy chain.

This precision attenuator can measure up to 6GHz frequency range with high amplitude accuracy. Use OffsetDB: +060 when connected to this attenuator.

For more details and ordering [visit this link](#).

6GHz SMA Attenuator - 10dB



This precision attenuator can measure up to 6GHz frequency range with high amplitude accuracy.

Use OffsetDB: +010 when connected to this attenuator.

For more details and ordering [visit this link](#).

6GHz SMA Attenuator - 30dB



This precision attenuator can measure up to 6GHz frequency range with high amplitude accuracy.

Use OffsetDB: +030 when connected to this attenuator.

For more details and ordering [visit this link](#).

RF Explorer Power Limiter

The RF Explorer Power Limiter is a custom device designed from scratch to be the perfect protection against strong RF fields.



All RF Explorer models have some power ranges for input signal beyond which can be damaged. For some models, the limit is on +5dBm, some others are ok up to +10dBm but only 6G, 6G Combo, and the RF SMA connector on the right side in a 3G Combo are protected up to +30dBm. See the table in page 47 for more details.



The RF Explorer Power Limiter will allow any RF Explorer model to be protected with external signals up to +30dBm (1 Watt), so you get the same level of protection as in the WSUB3G. Furthermore, the power limiter includes additional functionality inside that will otherwise require external devices increasing cost and size:

Power limiter: protection up to +30dBm, for any frequency range between DC-3000Mhz

DC block: You can connect any external DC source up to 16V with no risk of damaging your RF Explorer or interfering in your measurement.

Attenuator: Includes an internal 6dB attenuator to help you extend the range of power signal measurements. 6dB attenuation means only $\frac{1}{4}$ of the input power is received by the unit. To compensate for this extra attenuation you should indicate OffsetDB: +006 in the ATTENUATOR MENU of your RF Explorer.

The Power Limiter is assembled in a rugged aluminum case and it is very compact when compared to other market offerings, not to mention it includes internal DC block and attenuator which makes it a really small device for what it offers. It is a recommended add-on to all users who may expose their unit to strong external fields.

For more details and ordering [visit this link](#).

Feature

- Robust, small and low weight custom aluminum case
- 3-in-1 device with Power Limiter, DC Block and Attenuator
- Easy to connect and disconnect when required
- Wide broadband frequency application
- Directional 1 Watt rating
- Suitable for all RF Explorer models, not required for WSUB3G.

Specification

- Frequency range: DC ~ 3.0 GHz
- DC block: +16V DC
- Input Power rating: 1 Watt (+30dBm)
- Output power max: +4 dBm
- Attenuation: 6 dB
- Impedance (Nominal): 50Ω
- V.S.W.R (Max): 1.25 : 1
- Connector type: SMA male – female
- Connector: Brass / Gold plating

RF Explorer Holder – PLUS SLIM version

This custom made, high quality holder is the perfect support for your RF Explorer SLIM model, offering protection and convenient viewing angles.



It is made from ABS which results in a compact, lightweight and robust design, perfect to carry on where your RF Explorer goes. Any compatible USB cable can be connected from the side while the RF Explorer device remains fully operational. Also, it includes 4 x M2 screw holes at the bottom for easy attaching to underneath surfaces.

Please note that this is only suitable for the following RF Explorer SLIM models:

- RF Explorer WSUB1G+ SLIM
- RF Explorer ISM COMBO+ SLIM
- RF Explorer 4G COMBO+ SLIM
- RF Explorer 6G COMBO+ SLIM

Features

- Compact and light weight design for portability
- Made of rigid ABS material for protection
- Offers convenient viewing angles
- Easy connection to USB port

For more details and ordering [visit this link](#).



RF Explorer Holder – Standard version



This is a great accessory for the RF Explorer, a high quality stand / holder for the desk while USB cable is connected.

The holder is made of robust laser cut blue acrylic and has provisioned room for a USB cable to connect to a PC.

The USB cable can be connected from behind the holder or any of the two lateral large holes on each side. They're even large enough for bulky USB cables with ferrite beads.

A pre-drilled support bracket at the bottom allows for optionally securing the stand onto a bench for permanent position.

For more details and ordering [visit this link](#).

Feature

- Sturdy 3mm acrylic body
- Color: blue and silver
- Secure support for your RF Explorer
- Nice and practical design
- Comes flat-packed, assembly required.

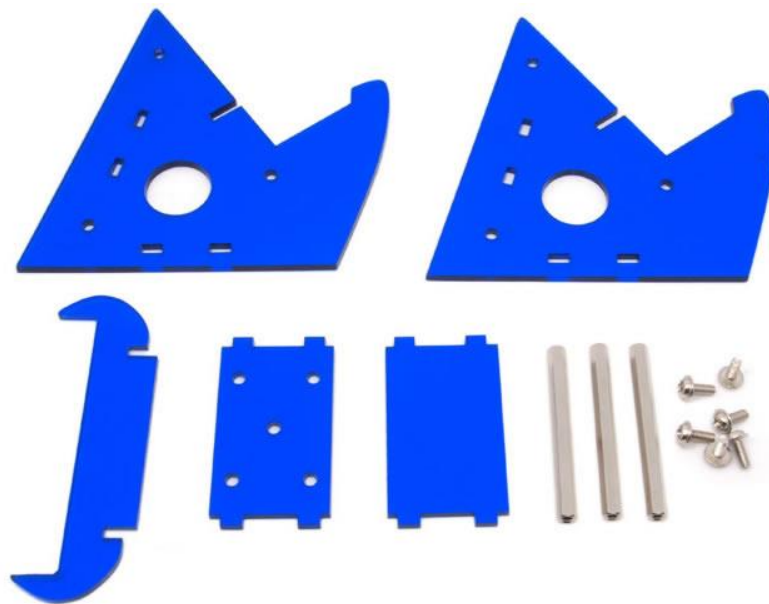

RF Explorer accessories

RF Explorer uses standard SMA quality connectors.

By using adapters, you can connect RF Explorer to any RF device or antenna. You can buy SMA adapters and devices on any RF shop, but sometimes is difficult to find what you need and have the certainty the connector you are ordering is the right one. Therefore, we have included a selection of quality connectors, adapters and RF devices that are fully compatible with RF Explorer. You can order them from SeedStudio as well as many of the RF Explorer distributors.

www.rf-explorer.com/buy

SMA-BNC adapter SMA Plug to BNC Jack straight



Usually HAM and two-way handheld radio antennas and devices are designed for BNC connectors. This BNC-female to SMA-male connector will easily interface your RF Explorer to any other BNC antenna or cable.

SMA-N adapter SMA Plug to N Jack straight



Laboratory grade RF bench size instruments use N connector size cables in most cases. This N-female to SMA-male connector will easily interface your RF Explorer to any other bench size instrument or cable.

RF Adapter RP-SMA Jack to SMA Plug straight-long version



Some WiFi antennas and cables are designed for RP-SMA (reverse polarity SMA) and cannot be connected to a standard SMA plug. RP-SMA is a variation of the SMA connector specification which reverses the gender of the interface.

The reason for that was a decision made by FCC in order to prevent end-users from manipulating certified WiFi devices at home, using other available SMA antennas. That led to SMA and RP-SMA devices not being able to connect without an adapter, check [Wikipedia for](#)

[more details](#)⁴.

If you want to use some standard WiFi antennas you may need this adapter in order to interface them with RF Explorer. By plugin in this adapter your RF Explorer will be able to connect with any RP-SMA antenna, cable or device.

SMA adapter SMA Plug to SMA Jack right angle



This RF connector is ideal to use RF Explorer deployed horizontally, with any antenna connected onto it.

For instance, when you are on the road and you don't have a RF Explorer Stand, you can still easily fit the USB cable, the antenna and connect to a computer with easy.

It is also useful to create a more reliable ground-effect for a dipole antenna if RF Explorer is over a metallic structure such as a car.

⁴ http://en.wikipedia.org/wiki/RP-SMA#Reverse_polarity_SMA

SMA connection cables

RF cables are an important tool required to directly connect your Spectrum Analyzer to another device (such as a RF transmitter or an antenna) or with a Signal Generator for tracking.

Cables add attenuation to your measurement and, if not correctly connected or if the cable is low quality, it may largely invalidate any measurement. If you use a large cable with known attenuation at a certain frequency, you can compensate that attenuation in the OffsetDB parameter in the CONFIG MENU of the RF Explorer device.

Different cables have different purposes. For frequencies up to 2.4GHz, we recommend flexible RG-316 cables, whereas higher quality and shorter lengths are suggested for frequencies up to 6GHz, where semi rigid RG402 is recommended.

10cm length - SMA male to SMA female 6GHz coaxial cable



This SMA male to female is a quality cable able to handle 6GHz with very low attenuation. It is the perfect cable to connect the RF Explorer Signal Generator to a device, or to work as a tracking generator.

The semi-rigid nature of the cable allows for stable measurement independently of the position and helps on adding mechanical robustness when using RF Explorer Signal Generator with RF Explorer Spectrum Analyzer as Tracking Generator. You will typically need two of these cables to connect the Tracking Generator to a device (with two SMA male connectors) or use an equivalent Male to

Female version for a device with different SMA gender connectors.

10cm length - SMA male to SMA male 6GHz coaxial cable



This SMA male to male is a quality cable able to handle 6GHz with very low attenuation. It is the perfect cable to connect the RF Explorer Signal Generator to a device, or to work as a tracking generator.

The semi-rigid nature of the cable allows for stable measurement independently of the position and helps on adding mechanical robustness when using RF Explorer Signal Generator with RF Explorer Spectrum Analyzer as Tracking Generator. You will typically need two of these cables to connect the Tracking Generator to a device (with two SMA female connectors) or use an equivalent Male to Female version for a device with different SMA gender connectors.

50cm length - SMA male to SMA female RF pigtail Coaxial Cable RG316



RF cables are required when connecting RF Explorer to other instruments or devices.

This 50cm cable is good for any frequency up to 3GHz, and can fit RF Explorer with any external SMA-male device or antenna.

If you need extra length for your connection, you can easily daisy chain two or more of these cables in series.

50cm length - SMA male to SMA male plug pigtail cable RG316



RF cables are required when connecting RF Explorer to other instruments or devices.

This 50cm cable is good for any frequency up to 3GHz, and can fit RF Explorer with any external SMA-female device or antenna.

SMA Male/Female Adaptor



All RF connectors wear with use. The RF Explorer SMA ports are subject to minimal wear each time the connector interface is coupled and decoupled with an antenna, a SMA cable, an attenuator or a RF device of any kind.

If you repeat plug/unplug operations over the RF Explorer SMA port hundreds of times, the SMA port may underperform over time and exhibit undesired attenuation.

To protect the SMA port for frequent plug/unplug operations, you can use this adaptor and keep it directly attached to the RF Explorer port. Then you plug/unplug other RF devices into this adaptor, not the original SMA port. After hundreds of operations, if the adaptor wear and show attenuation or reliability problems, you can just replace it by a new one and always keep your original RF Explorer SMA port intact.

SMA Termination – 50 ohm dummy load



Using SMA termination or Dummy Load is suggested for protection of the SMA port of your RF Explorer when the device is exposed to unwanted high radiation or strong electronic fields.

For instance, if you carry on your RF Explorer that is exposed to an X-Ray scanner in the airport, you should remove the SMA antenna and plug a protection 50 ohm SMA termination.

SMA termination are also required when using Signal Generator while not connected to an antenna; in this way the generator sees a correct load to avoid damage.

Connecting RF Explorer to a computer

RF Explorer device can be connected to a computer (Windows, Linux, Mac and Android) for additional capabilities, including higher resolution screen, additional features and programmability.

For free, open-source RF Explorer for Windows tool, please check this link:

www.rf-explorer.com/windows

For additional software options developed by a growing list of 3rd party companies, please check this link:

www.rf-explorer.com/software

API SDK programming specification for RF Explorer

RF Explorer offers a compact, easy to use, USB / RS232 programming interface. It can be used to automate external solutions when connected to an external computer or device.

For full specification of the current API, check this online page:

www.rf-explorer.com/API

There are [.NET](#) and [Python](#) libraries available in [GITHUB](#) repository, ideal for custom work required by your application.

RF Explorer for Windows open source code

RF Explorer is a hacker friendly device. Full open source under LPGL license is offered to the community.

As hackers ourselves, we do like customizing, tinkering and expanding gadgets. We certainly designed and built RF Explorer with these factors in mind.

We love and make good use of all community contributions; contact us or send us a <pull request> if you have source code contributions you want integrated in the final product.

Check our [hacker corner link](#) for more details:

www.rf-explorer.com/hacker

Specifications

For a complete list of features and RF Explorer models, expansion boards available, and accessories please check the RF Explorer Model Map online.

www.rf-explorer.com/models

Acknowledgments

This product could not be possible without the SeeedStudio Team who manufacture, test and distribute RF Explorer worldwide.

RF Explorer is a reality thanks to the great community behind, always suggesting features and providing useful feedback.

FCC and CE regulations

RF Explorer is a Test and Measurement device, and therefore compatible with US FCC regulation 47 CFR Part 15.103(c).

RF Explorer is certified for CE compliance under regulations EN/IEC61236 and EN/IEC61000.

License

RF Explorer embedded firmware is copyrighted © by RF Explorer Technologies SL, 2010-2021

RF Explorer for Windows is Open Source software released under GPL v3, so you are free to modify, distribute and use it based on GPL terms.

RF Explorer is a registered trademark in USA, China, Australia, Canada, Japan and all EU Countries.

RF Explorer is protected by multiple patents in major countries.