

LP3995

LP3995 Micropower 150mA CMOS Voltage Regulator with Active Shutdown



Literature Number: SNVS179D

LP3995

Micropower 150mA CMOS Voltage Regulator with Active Shutdown

General Description

The LP3995 linear regulator is designed to meet the requirements of portable battery-powered applications and will provide an accurate output voltage with low noise and low quiescent current. Ideally suited for powering RF/Analog devices, this device will also be used to meet more general circuit needs in which a fast turn-off is essential.

For battery powered applications the low dropout and low ground current provided by the device allows the lifetime of the battery to be maximized. The Enable/(Disable) control allows the system to further extend the battery lifetime by reducing the power consumption to virtually zero.

The Enable/(Disable) function on the device incorporates an active discharge circuit on the output for faster device shutdown. Where the fast turn-off is not required the LP3999 linear regulator is recommended.

The LP3995 also features internal protection against short-circuit currents and over-temperature conditions.

The LP3995 is designed to be stable with small 1.0 μF ceramic capacitors. The small outline of the LP3995 micro SMD package with the required ceramic capacitors can realize a system application within minimal board area.

Performance is specified for a -40°C to $+125^{\circ}\text{C}$ temperature range.

The device is available in micro SMD package and LLP package. For other package options contact your local NSC sales office.

The device is available in fixed output voltages in the ranges 1.5V to 3.3V. For availability, please contact your local NSC sales office.

Key Specifications

- 2.5V to 6.0V Input Range
- Accurate Output Voltage; $\pm 75\text{mV} / 2\%$
- 60 mV Typical Dropout with 150 mA Load
- Virtually Zero Quiescent Current when Disabled
- Low Output Voltage Noise
- Stable with a 1 μF Output Capacitor
- Guaranteed 150 mA Output Current
- Fast Turn-on; 30 μs (Typ.)
- Fast Turn-off; 175 μs (Typ.)

Features

- 5 pin micro SMD Package
- 6 pin LLP Package
- Stable with Ceramic Capacitor
- Logic Controlled Enable
- Fast Turn-on
- Active Disable for Fast Turn-off.
- Thermal-overload and Short-circuit Protection
- -40 to $+125^{\circ}\text{C}$ Junction Temperature Range for Operation

Applications

- GSM Portable Phones
- CDMA Cellular Handsets
- Wideband CDMA Cellular Handsets
- Bluetooth Devices
- Portable Information Appliances

Typical Application Circuit

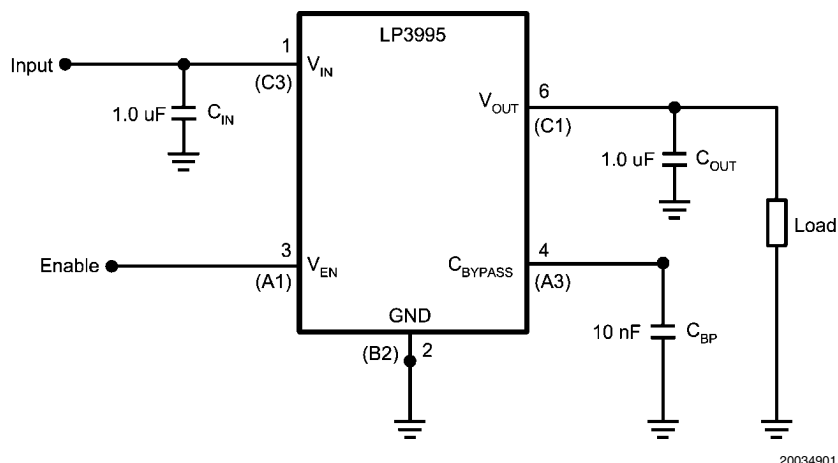

Block Diagram

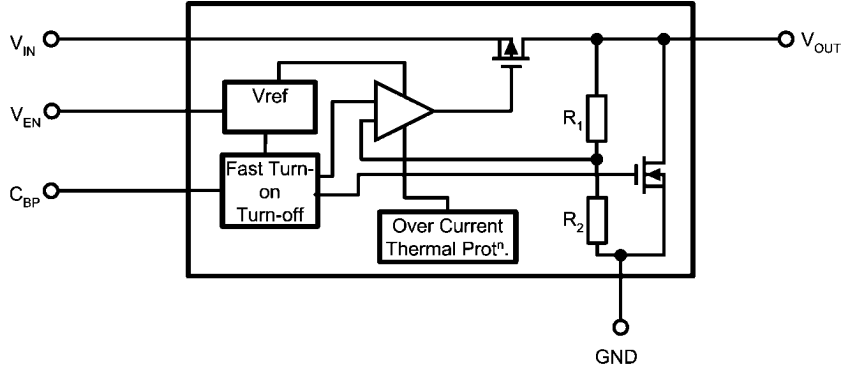

20034902

Pin Descriptions

5 Pin micro SMD and LLP - 6

| Pin No. | | Symbol | Name and Function |
|-----------|-----|--------------|--|
| micro SMD | LLP | | |
| A1 | 3 | V_{EN} | Enable Input; Disables the Regulator when $\leq 0.4V$. Enables the regulator when $\geq 0.9V$ |
| B2 | 2 | GND | Common Ground |
| C1 | 6 | V_{OUT} | Voltage output. Connect this output to the load circuit. |
| C3 | 1 | V_{IN} | Voltage Supply Input |
| A3 | 4 | C_{BYPASS} | Bypass Capacitor connection. Connect a $0.01 \mu F$ capacitor for noise reduction. |
| | 5 | N/C | No internal connection. There should not be any board connection to this pin. |
| | Pad | GND | Ground connection. Connect to ground plane for best thermal conduction. |

Connection Diagrams

micro SMD, 5 Bump Package

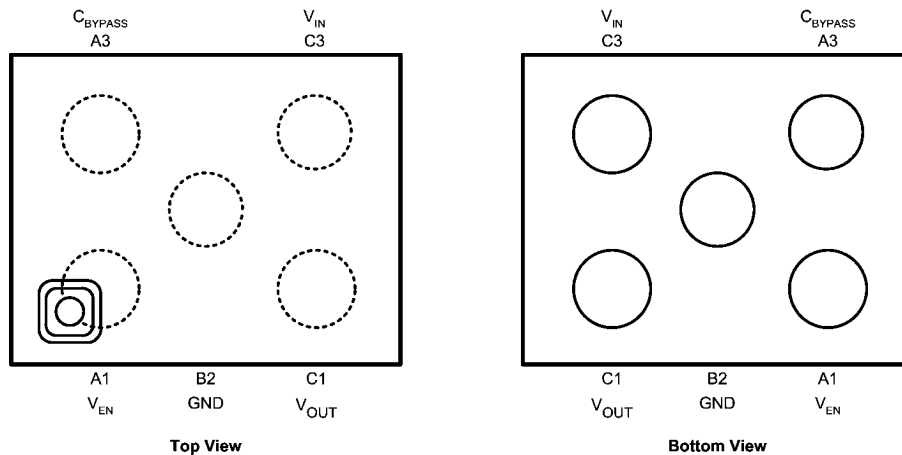

Top View
See NS Package Number TLA05

20034903

LLP- 6 Package (SOT23 Footprint)

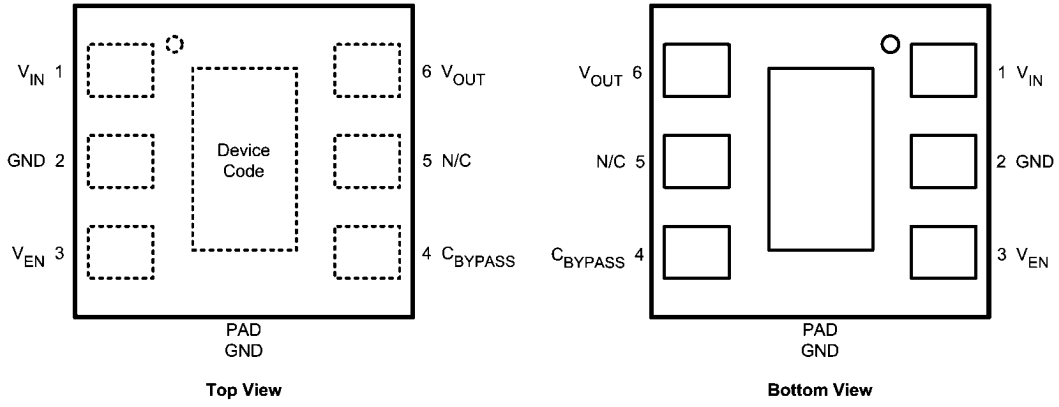

20034904

Top View
See NS Package Number LDE06A

Ordering Information

For micro SMD Package

| Output Voltage (V) | Grade | LP3995 Supplied as 250 Units, Tape and Reel | LP3995 Supplied as 3000 Units, Tape and Reel | Package Marking |
|--------------------|-------|---|--|-----------------|
| 1.5 (Note 2) | STD | LP3995ITL-1.5 | LP3995ITLX-1.5 | XV I9 |
| 1.6 (Note 2) | STD | LP3995ITL-1.6 | LP3995ITLX-1.6 | XV I9 |
| 1.8 (Note 2) | STD | LP3995ITL-1.8 | LP3995ITLX-1.8 | XV I9 |
| 1.9 (Note 2) | STD | LP3995ITL-1.9 | LP3995ITLX-1.9 | XV I9 |
| 2.1 (Note 2) | STD | LP3995ITL-2.1 | LP3995ITLX-2.1 | XV I9 |
| 2.5 (Note 2) | STD | LP3995ITL-2.5 | LP3995ITLX-2.5 | XV I9 |
| 2.8 (Note 2) | STD | LP3995ITL-2.8 | LP3995ITLX-2.8 | XV I9 |
| 2.85 (Note 2) | STD | LP3995ITL-2.85 | LP3995ITLX-2.85 | XV I9 |
| 3.0 (Note 2) | STD | LP3995ITL-3.0 | LP3995ITLX-3.0 | XV I9 |

For micro SMD Package (Lead Free)

| Output Voltage (V) | Grade | LP3995 Supplied as 250 Units, Tape and Reel | LP3995 Supplied as 3000 Units, Tape and Reel | Package Marking |
|--------------------|-------|---|--|-----------------|
| 1.5 | STD | LP3995ITL-1.5/NOPB | LP3995ITLX-1.5/NOPB | XV I9 |
| 1.6 | STD | LP3995ITL-1.6/NOPB | LP3995ITLX-1.6/NOPB | XV I9 |
| 1.8 | STD | LP3995ITL-1.8/NOPB | LP3995ITLX-1.8/NOPB | XV I9 |
| 1.9 | STD | LP3995ITL-1.9/NOPB | LP3995ITLX-1.9/NOPB | XV I9 |
| 2.1 | STD | LP3995ITL-2.1/NOPB | LP3995ITLX-2.1/NOPB | XV I9 |
| 2.5 | STD | LP3995ITL-2.5/NOPB | LP3995ITLX-2.5/NOPB | XV I9 |
| 2.7 | STD | LP3995ITL-2.7/NOPB | LP3995ITLX-2.7/NOPB | XV I9 |
| 2.8 | STD | LP3995ITL-2.8/NOPB | LP3995ITLX-2.8/NOPB | XV I9 |
| 2.85 | STD | LP3995ITL-2.85/NOPB | LP3995ITLX-2.85/NOPB | XV I9 |
| 3.0 | STD | LP3995ITL-3.0/NOPB | LP3995ITLX-3.0/NOPB | XV I9 |

For LLP- 6 Package

| Output Voltage (V) | Grade | LP3995 Supplied as 1000 Units, Tape and Reel | LP3995 Supplied as 4500 Units, Tape and Reel | Package Marking |
|--------------------|-------|--|--|-----------------|
| 1.5 | STD | LP3995ILD-1.5 | LP3995ILD-1.5 | LO20B |
| 1.6 | STD | LP3995ILD-1.6 | LP3995ILD-1.6 | LO21B |
| 1.8 | STD | LP3995ILD-1.8 | LP3995ILD-1.8 | LO22B |
| 2.8 | STD | LP3995ILD-2.8 | LP3995ILD-2.8 | LO26B |
| 3.0 | STD | LP3995ILD-3.0 | LP3995ILD-3.0 | LO30B |

Note 1: Available in sample quantities only

Note 2: For availability contact your local sales office

Absolute Maximum Ratings

(Notes 3, 4)

If Military/Aerospace specified devices are required, please contact the National Semiconductor Sales Office/Distributors for availability and specifications.

| | |
|-------------------------------|--|
| Input Voltage (V_{IN}) | -0.3 to 6.5V |
| Output Voltage | -0.3 to ($V_{IN} + 0.3V$) to 6.5V (max) |
| Enable Input Voltage | -0.3 to 6.5V |
| Junction Temperature | 150°C |
| Lead/Pad Temperature (Note 5) | |
| micro SMD | 260°C |
| LLP | 235°C |
| Storage Temperature | -65 to +150°C |
| Continuous Power Dissipation | Internally Limited (Note 7) |
| ESD (Note 9) | |
| Human Body Model | 2 kV |
| Machine Model | 200V |

Operating Ratings (Note 3)

| | |
|------------------------------------|---------------|
| Input Voltage (V_{IN}) | 2.5 to 6.0V |
| Enable Input Voltage | 0 to 6.0V |
| Junction Temperature | -40 to +125°C |
| Ambient Temperature Range (Note 7) | -40 to 85°C |

Thermal Properties (Note 8)

| | |
|--|---------|
| Junction to Ambient Thermal Resistance | |
| θ_{JA} (LLP pkg.) | 88°C/W |
| θ_{JA} (micro SMD pkg.) | 255°C/W |

Electrical Characteristics

Unless otherwise noted, $V_{EN} = 1.5$, $V_{IN} = V_{OUT} + 1.0V$, $C_{IN} = 1 \mu F$, $I_{OUT} = 1$ mA, $C_{OUT} = 1 \mu F$, $c_{BP} = 0.01 \mu F$. Typical values and limits appearing in normal type apply for $T_J = 25^\circ C$. Limits appearing in **boldface** type apply over the full temperature range for operation, -40 to +125°C. (Notes 14, 15)

| Symbol | Parameter | Conditions | Typical | Limit | | Units |
|---|---|---|---------|-------------|------------|------------|
| | | | | Min | Max | |
| V_{IN} | Input Voltage | | | 2.5 | 6.0 | V |
| DEVICE OUTPUT: $1.5 \leq V_{OUT} < 1.8V$ | | | | | | |
| ΔV_{OUT} | Output Voltage Tolerance | $I_{OUT} = 1$ mA | | -50 | 50 | mV |
| | | | | -75 | 75 | |
| | Line Regulation Error | $V_{IN} = (V_{OUT(NOM)} + 1.0V)$ to 6.0V, $I_{OUT} = 1$ mA | | -3.5 | 3.5 | mV/V |
| | micro SMD Load Regulation Error | $I_{OUT} = 1$ mA to 150 mA | 10 | | 75 | $\mu V/mA$ |
| | LLP Load Regulation Error | $I_{OUT} = 1$ mA to 150 mA | 70 | | 125 | $\mu V/mA$ |
| PSRR | Power Supply Rejection Ratio (Note 11) | $f = 1$ kHz, $I_{OUT} = 1$ mA | 55 | | | dB |
| | | $f = 10$ kHz, $I_{OUT} = 1$ mA | 53 | | | |
| DEVICE OUTPUT: $1.8 \leq V_{OUT} < 2.5V$ | | | | | | |
| ΔV_{OUT} | Output Voltage Tolerance | $I_{OUT} = 1$ mA | | -50 | 50 | mV |
| | | | | -75 | 75 | |
| | microSMD Line Regulation Error | $V_{IN} = (V_{OUT(NOM)} + 1.0V)$ to 6.0V, $I_{OUT} = 1$ mA | | -2.5 | 2.5 | mV/V |
| | LLP Line Regulation Error | $V_{IN} = (V_{OUT(NOM)} + 1.0V)$ to 6.0V, $I_{OUT} = 1$ mA | | -3.5 | 3.5 | mV/V |
| | micro SMD Load Regulation Error | $I_{OUT} = 1$ mA to 150 mA | 10 | | 75 | $\mu V/mA$ |
| | LLP Load Regulation Error | $I_{OUT} = 1$ mA to 150 mA | 80 | | 125 | $\mu V/mA$ |
| PSRR | Power Supply Rejection Ratio (Note 11) | $f = 1$ kHz, $I_{OUT} = 1$ mA | 55 | | | dB |
| | | $f = 10$ kHz, $I_{OUT} = 1$ mA | 50 | | | |

| Symbol | Parameter | Conditions | Typical | Limit | | Units |
|---|--|---|-----------|-------|----------|-------------------------|
| | | | | Min | Max | |
| DEVICE OUTPUT: $2.5 \leq V_{OUT} \leq 3.3V$ | | | | | | |
| ΔV_{OUT} | Output Voltage Tolerance | $I_{OUT} = 1 \text{ mA}$ | | -2 | 2 | % of V_{OUT} (NOM) |
| | Line Regulation Error | $V_{IN} = (V_{OUT(NOM)} + 1.0V)$ to 6.0V, $I_{OUT} = 1 \text{ mA}$ | | -0.1 | 0.1 | %/V |
| | micro SMD Load Regulation Error | $I_{OUT} = 1 \text{ mA}$ to 150 mA | 0.0004 | | 0.002 | %/mA |
| | LLP Load Regulation Error | $I_{OUT} = 1 \text{ mA}$ to 150 mA | 0.002 | | 0.005 | %/mA |
| | Dropout Voltage | $I_{OUT} = 1 \text{ mA}$ $I_{OUT} = 150 \text{ mA}$ | 0.4 60 | | 2 100 | mV |
| PSRR | Power Supply Rejection Ratio (Note 11) | $f = 1 \text{ kHz}$, $I_{OUT} = 1 \text{ mA}$ | 60 | | | dB |
| | | $f = 10 \text{ kHz}$, $I_{OUT} = 1 \text{ mA}$ | 50 | | | |
| FULL V_{OUT} RANGE | | | | | | |
| I_{LOAD} | Load Current | (Notes 10, 11) | | 0 | | μA |
| I_Q | Quiescent Current | $V_{EN} = 1.5V$, $I_{OUT} = 0 \text{ mA}$ | 85 | | 150 | μA |
| | | $V_{EN} = 1.5V$, $I_{OUT} = 150 \text{ mA}$ | 140 | | 200 | |
| | | $V_{EN} = 0.4V$ | 0.003 | | 1.5 | |
| I_{SC} | Short Circuit Current Limit | | 450 | | | mA |
| E_N | Output Noise Voltage ((Note 11)) | BW = 10 Hz to 100 kHz, $V_{IN} = 4.2V$, $I_{OUT} = 1 \text{ mA}$ | 25 | | | μVrms |
| $T_{SHUTDOWN}$ | Thermal Shutdown | Temperature | 160 | | | $^{\circ}\text{C}$ |
| | | Hysteresis | 20 | | | |
| ENABLE CONTROL CHARACTERISTICS | | | | | | |
| I_{EN} | Maximum Input Current at V_{EN} Input | $V_{EN} = 0.0V$ and $V_{IN} = 6.0V$ | 0.001 | | | μA |
| V_{IL} | Low Input Threshold | | | | 0.4 | V |
| V_{IH} | High Input Threshold | | | 0.9 | | V |
| TIMING CHARACTERISTICS | | | | | | |
| T_{ON} | Turn On Time (Note 11) | To 95% Level (Note 12) | 30 | | | μs |
| T_{OFF} | Turn Off Time (Note 11) | To 5% Level (Note 13) | 175 | | | μs |

Note 3: Absolute Maximum Ratings are limits beyond which damage to the device may occur. Operating Ratings are conditions under which operation of the device is guaranteed. Operating Ratings do not imply guaranteed performance limits. For guaranteed performance limits and associated test conditions, see the Electrical Characteristics tables.

Note 4: All voltages are with respect to the potential at the GND pin.

Note 5: For information regarding micro SMD and LLP packages please refer to the following application notes;

AN-1112 Micro SMD Package Wafer Level Chip Scale Package,

AN-1187. Leadless Leadframe Package.

Note 6: Internal Thermal shutdown circuitry protects the device from permanent damage.

Note 7: In applications where high power dissipation and/or poor thermal resistance is present, the maximum ambient temperature may have to be derated. Maximum ambient temperature ($T_{A(max)}$) is dependant on the maximum operating junction temperature ($T_{J(max-op)}$), the maximum power dissipation ($P_{D(max)}$), and the junction to ambient thermal resistance in the application (θ_{JA}). This relationship is given by :-

$$T_{A(max)} = T_{J(max-op)} - (P_{D(max)} \times \theta_{JA})$$

Note 8: Junction to ambient thermal resistance is highly dependant on the application and board layout. In applications where high thermal dissipation is possible, special care must be paid to thermal issues in the board design.

Note 9: The human body model is an 100 pF discharge through a 1.5 k Ω resistor into each pin. The machine model is a 200 pF capacitor discharged directly into each pin.

Note 10: The device maintains a stable, regulated output voltage without load.

Note 11: This electrical specification is guaranteed by design.

Note 12: Time from $V_{EN} = 0.9V$ to $V_{OUT} = 95\%$ ($V_{OUT(NOM)}$)

Note 13: Time from $V_{EN} = 0.4V$ to $V_{OUT} = 5\%$ ($V_{OUT(NOM)}$)

Note 14: All limits are guaranteed. All electrical characteristics having room-temperature limits are tested during production at $T_j = 25^\circ\text{C}$ or correlated using Statistical Quality Control methods. Operation over the temperature specification is guaranteed by correlating the electrical characteristics to process and temperature variations and applying statistical process control.

Note 15: $V_{\text{OUT(NOM)}}$ is the stated output voltage option for the device.

Recommended Output Capacitor

| Symbol | Parameter | Conditions | VALUE | Limit | | Units |
|------------------|------------------|-----------------------|-------|-------|-----|------------------|
| | | | | Min | Max | |
| C_{OUT} | Output Capacitor | Capacitance (Note 16) | 1.0 | 0.70 | | μF |
| | | ESR | | 5 | 500 | $\text{m}\Omega$ |

Note 16: The capacitor tolerance should be $\pm 30\%$ or better over the temperature range. The recommended capacitor type is X7R however, dependant on the application X5R, Y5V, and Z5U can also be used.

Input Test Signals

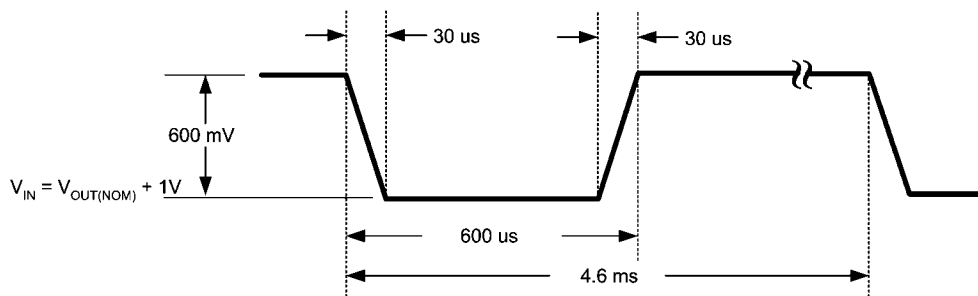

20034906

FIGURE 1. Line Transient Response Input Test Signal

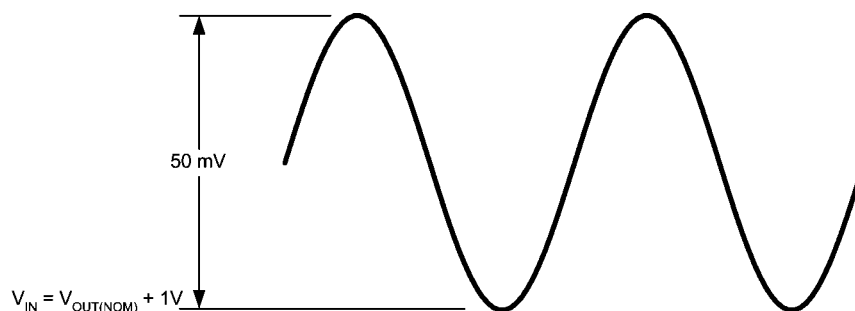

20034907

FIGURE 2. PSRR Input Test Signal

Typical Performance Characteristics

$V_{OUT} + 1.0V$, $T_A = 25^\circ C$, Enable pin is tied to V_{IN} .

Unless otherwise specified, $C_{IN} = C_{OUT} = 1.0 \mu F$ Ceramic, $V_{IN} =$

Output Voltage Change vs Temperature

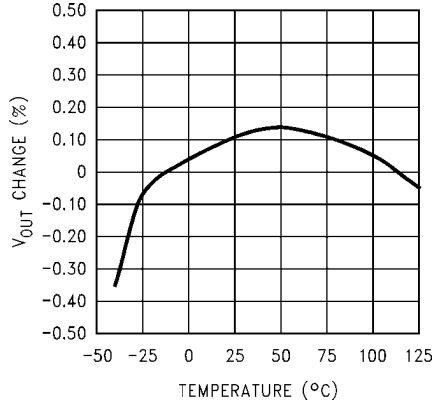

20034910

Ground Current vs Load Current (1.8V V_{OUT})

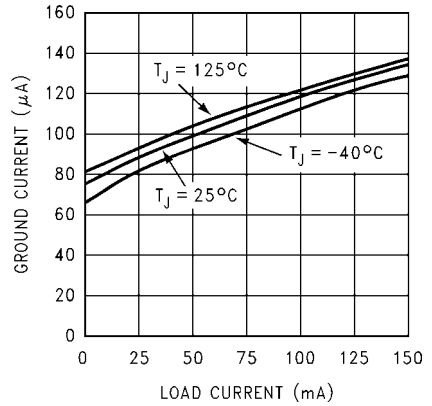

20034911

Ground Current vs Load Current (2.8V V_{OUT})

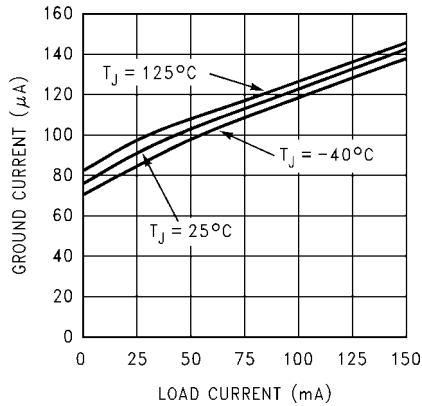

20034912

Ground Current vs V_{IN} @ 25°C

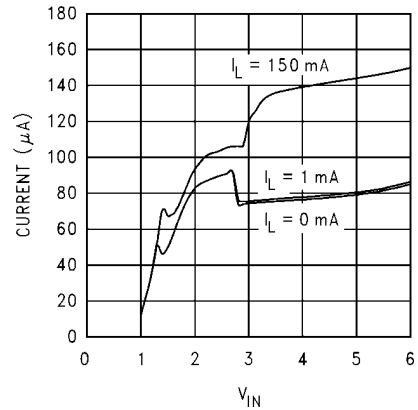

20034913

Ground Current vs V_{IN} @ 125°C

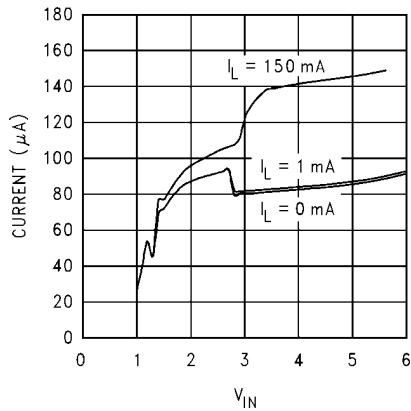

20034914

Dropout vs Load Current

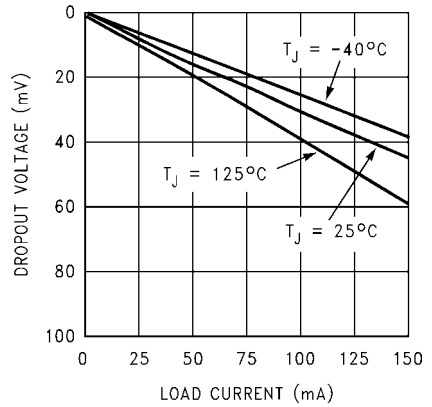

20034915

Short Circuit Current

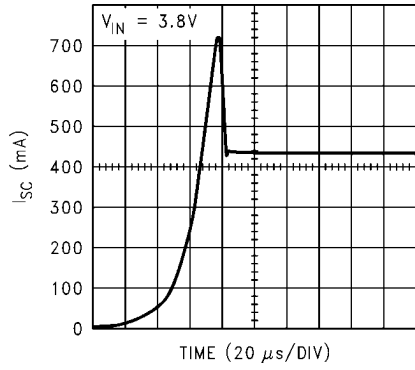

20034916

Line Transient Response ($V_{OUT} = 2.8V$)

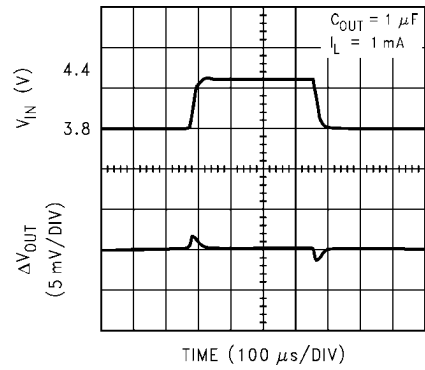

20034917

Ripple Rejection ($V_{OUT} = 1.8V$)

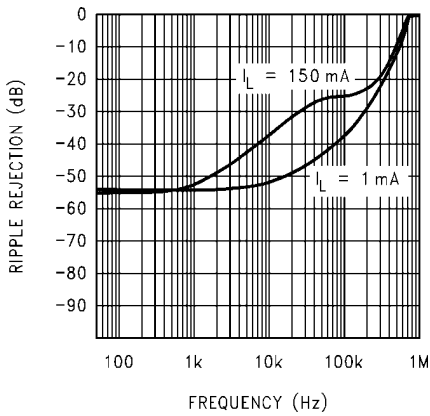

20034918

Ripple Rejection ($V_{OUT} = 2.8V$)

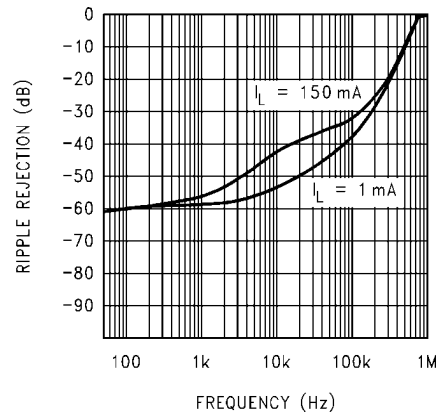

20034919

Enable Start-Up Time ($V_{OUT} = 2.8V$)

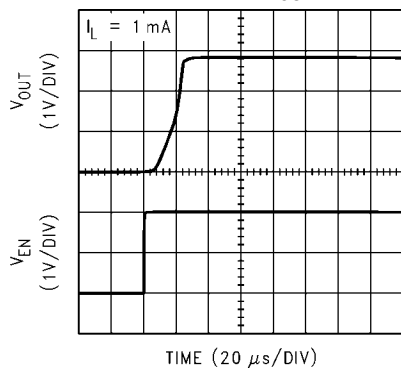

20034920

Enable Start-Up Time ($V_{OUT} = 2.8V$)

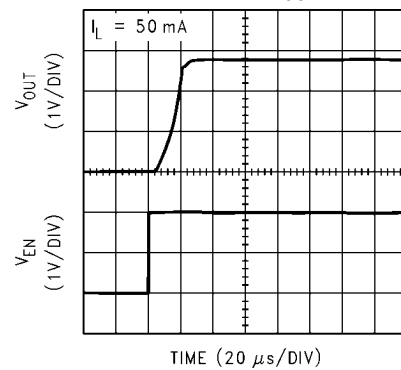

20034921

Enable Start-Up Time ($V_{OUT} = 1.8V$)

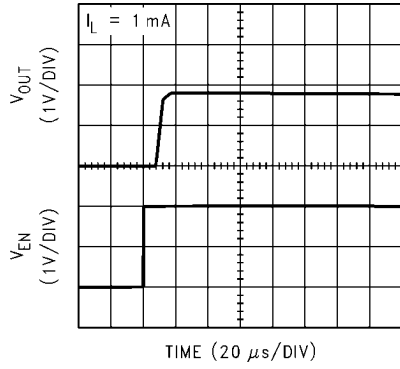

20034922

Enable Start-Up Time ($V_{OUT} = 1.8V$)

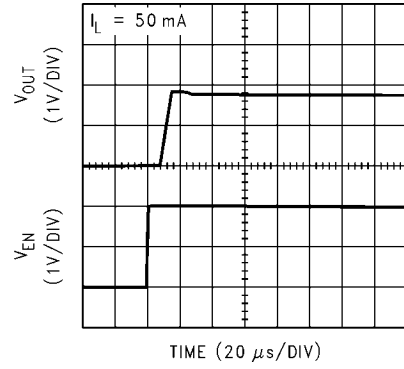

20034923

Turn-Off Time ($V_{OUT} = 2.8V$)

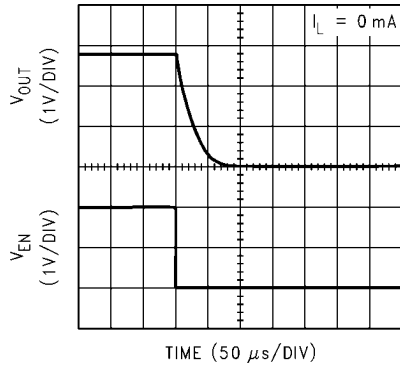

20034924

Turn-Off Time ($V_{OUT} = 1.8V$)

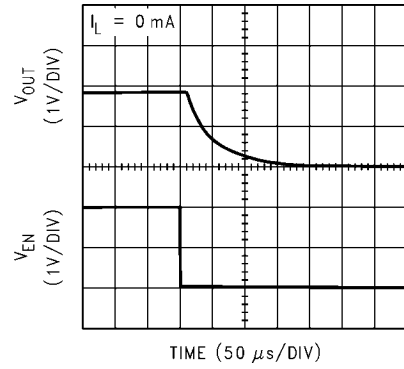

20034925

Load Transient Response ($V_{OUT} = 2.8V$)

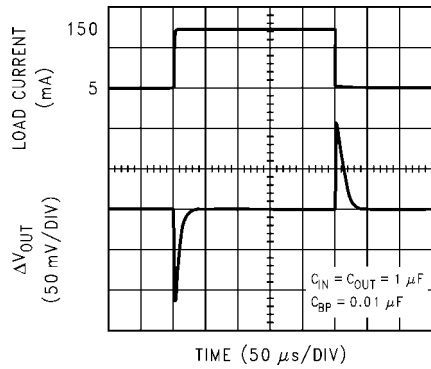

20034926

Load Transient Response ($V_{OUT} = 1.8V$)

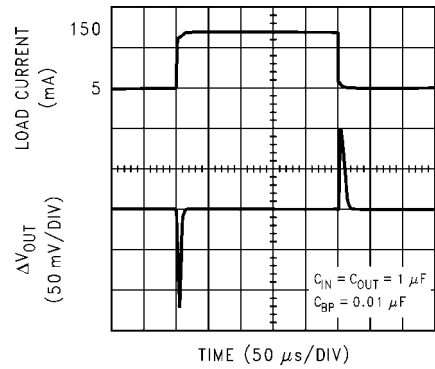

20034927

Application Hints

POWER DISSIPATION AND DEVICE OPERATION

The permissible power dissipation for any package is a measure of the capability of the device to pass heat from the power source, the junctions of the IC, to the ultimate heat sink, the ambient environment. Thus the power dissipation is dependent on the ambient temperature and the thermal resistance across the various interfaces between the die and ambient air.

The Thermal Resistance figure

Re-stating the equation in (Note 7) in the electrical specification section, the allowable power dissipation for the device in a given package can be calculated:

$$P_D = \frac{(T_{J(MAX)} - T_A)}{\theta_{JA}}$$

With a $\theta_{JA} = 255^\circ\text{C/W}$, the device in the micro SMD package returns a value of 392 mW with a maximum junction temperature of 125°C .

With a $\theta_{JA} = 88^\circ\text{C/W}$, the device in the LLP package returns a value of 1.136 mW with a maximum junction temperature of 125°C .

The actual power dissipation across the device can be represented by the following equation:

$$P_D = (V_{IN} - V_{OUT}) \times I_{OUT}$$

This establishes the relationship between the power dissipation allowed due to thermal consideration, the voltage drop across the device, and the continuous current capability of the device. These two equations should be used to determine the optimum operating conditions for the device in the application.

EXTERNAL CAPACITORS

In common with most regulators, the LP3995 requires external capacitors to ensure stable operation. The LP3995 is specifically designed for portable applications requiring minimum board space and smallest components. These capacitors must be correctly selected for good performance.

INPUT CAPACITOR

An input capacitor is required for stability. It is recommended that a $1.0 \mu\text{F}$ capacitor be connected between the LP3995 input pin and ground (this capacitance value may be increased without limit).

This capacitor must be located a distance of not more than 1 cm from the input pin and returned to a clean analogue ground. Any good quality ceramic, tantalum, or film capacitor may be used at the input.

Important: Tantalum capacitors can suffer catastrophic failures due to surge current when connected to a low-impedance source of power (like a battery or a very large capacitor). If a tantalum capacitor is used at the input, it must be guaranteed by the manufacturer to have a surge current rating sufficient for the application.

There are no requirements for the **ESR** (Equivalent Series Resistance) on the input capacitor, but tolerance and temperature coefficient must be considered when selecting the capacitor to ensure the capacitance will remain $\cong 1.0 \mu\text{F}$ over the entire operating temperature range.

OUTPUT CAPACITOR

The LP3995 is designed specifically to work with very small ceramic output capacitors. A ceramic capacitor (dielectric

types Z5U, Y5V or X7R) in the 1.0 [to $10 \mu\text{F}$] range, and with ESR between $5 \text{ m}\Omega$ to $500 \text{ m}\Omega$, is suitable in the LP3995 application circuit.

For this device the output capacitor should be connected between the V_{OUT} pin and ground.

It may also be possible to use tantalum or film capacitors at the device output, V_{OUT} , but these are not as attractive for reasons of size and cost (see the section Capacitor Characteristics).

The output capacitor must meet the requirement for the minimum value of capacitance and also have an ESR value that is within the range $5 \text{ m}\Omega$ to $500 \text{ m}\Omega$ for stability.

NO-LOAD STABILITY

The LP3995 will remain stable and in regulation with no external load. This is an important consideration in some circuits, for example CMOS RAM keep-alive applications.

CAPACITOR CHARACTERISTICS

The LP3995 is designed to work with ceramic capacitors on the output to take advantage of the benefits they offer. For capacitance values in the range of $1 \mu\text{F}$ to $4.7 \mu\text{F}$, ceramic capacitors are the smallest, least expensive and have the lowest ESR values, thus making them best for eliminating high frequency noise. The ESR of a typical $1 \mu\text{F}$ ceramic capacitor is in the range of $20 \text{ m}\Omega$ to $40 \text{ m}\Omega$, which easily meets the ESR requirement for stability for the LP3995.

The temperature performance of ceramic capacitors varies by type. Most large value ceramic capacitors ($\geq 2.2 \mu\text{F}$) are manufactured with Z5U or Y5V temperature characteristics, which results in the capacitance dropping by more than 50% as the temperature goes from 25°C to 85°C .

A better choice for temperature coefficient in a ceramic capacitor is X7R. This type of capacitor is the most stable and holds the capacitance within $\pm 15\%$ over the temperature range. Tantalum capacitors are less desirable than ceramic for use as output capacitors because they are more expensive when comparing equivalent capacitance and voltage ratings in the $1 \mu\text{F}$ to $4.7 \mu\text{F}$ range.

Another important consideration is that tantalum capacitors have higher ESR values than equivalent size ceramics. This means that while it may be possible to find a tantalum capacitor with an ESR value within the stable range, it would have to be larger in capacitance (which means bigger and more costly) than a ceramic capacitor with the same ESR value. It should also be noted that the ESR of a typical tantalum will increase about 2:1 as the temperature goes from 25°C down to -40°C , so some guard band must be allowed.

NOISE BYPASS CAPACITOR

A bypass capacitor should be connected between the C_{BP} pin and ground to significantly reduce the noise at the regulator output. This device pin connects directly to a high impedance node within the bandgap reference circuitry. Any significant loading on this node will cause a change on the regulated output voltage. For this reason, DC leakage current through this pin must be kept as low as possible for best output voltage accuracy.

The use of a $0.01 \mu\text{F}$ bypass capacitor is strongly recommended to prevent overshoot on the output during start-up.

The types of capacitors best suited for the noise bypass capacitor are ceramic and film. High quality ceramic capacitors with NPO or COG dielectric typically have very low leakage. Polypropylene and polycarbonate film capacitors are available in small surface-mount packages and typically have extremely low leakage current.

Unlike many other LDO's, the addition of a noise reduction capacitor does not effect the transient response of the device.

ENABLE OPERATION

The LP3995 may be switched ON or OFF by a logic input at the ENABLE pin, V_{EN} . A high voltage at this pin will turn the device on. When the enable pin is low, the regulator output is off and the device typically consumes 3 nA. If the application does not require the shutdown feature, the V_{EN} pin should be tied to V_{IN} to keep the regulator output permanently on. To ensure proper operation, the signal source used to drive the V_{EN} input must be able to swing above and below the specified turn-on/off voltage thresholds listed in the Electrical Characteristics section under V_{IL} and V_{IH} .

FAST TURN OFF AND ON

The controlled switch-off feature of the device provides a fast turn off by discharging the output capacitor via an internal FET device. This discharge is current limited by the R_{DSon} of this switch. Fast turn-on is guaranteed by control circuitry within the reference block allowing a very fast ramp of the output voltage to reach the target voltage.

micro SMD MOUNTING

The micro SMD package requires specific mounting techniques which are detailed in National Semiconductor Application Note AN-1112.

Referring to the section *Surface Mount Technology (SMT) Assembly Considerations*, it should be noted that the pad style which must be used with the 5 pin package is NSMD (non-solder mask defined) type.

For best results during assembly, alignment ordinals on the PC board may be used to facilitate placement of the micro SMD device.

micro SMD LIGHT SENSITIVITY

Exposing the micro SMD device to direct sunlight will cause incorrect operation of the device. Light sources such as halogen lamps can affect electrical performance if they are situated in proximity to the device.

Light with wavelengths in the red and infra-red part of the spectrum have the most detrimental effect thus the fluorescent lighting used inside most buildings has very little effect on performance. Tests carried out on a micro SMD test board showed a negligible effect on the regulated output voltage when brought within 1 cm of a fluorescent lamp. A deviation of less than 0.1% from nominal output voltage was observed.

Physical Dimensions inches (millimeters) unless otherwise noted

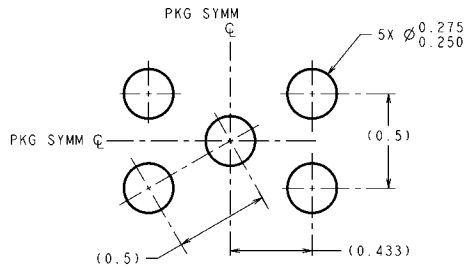

DIMENSIONS ARE IN MILLIMETERS
DIMENSIONS IN () FOR REFERENCE ONLY

LAND PATTERN RECOMMENDATION

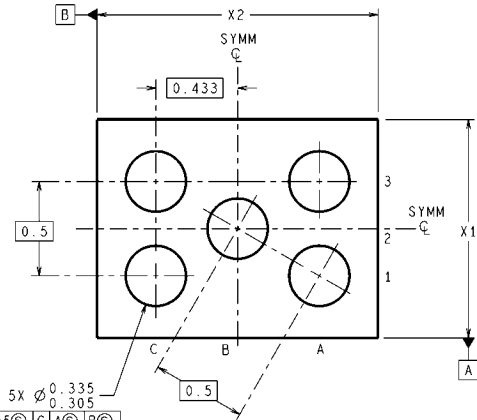
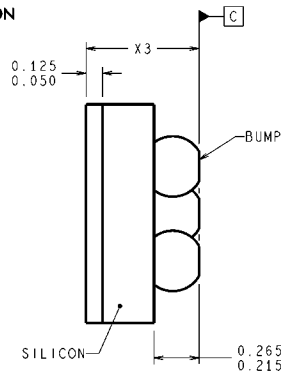
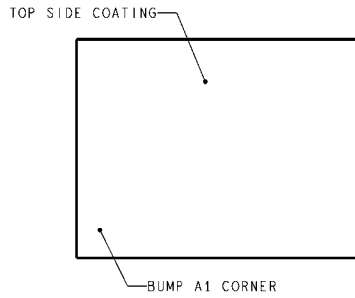

TLA05XXX (Rev C)

micro SMD, 5 Bump, Package (TLA05)
NS Package Number TLA05ADA
The dimensions for X1, X2 and X3 are given as:
X1 = 1.006 +/- 0.03mm
X2 = 1.438 +/- 0.03mm
X3 = 0.600 +/- 0.075mm

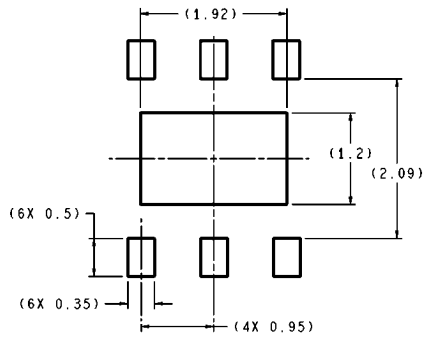

RECOMMENDED LAND PATTERN
1:1 RATIO WITH PKG SOLDER PADS

DIMENSIONS ARE IN MILLIMETERS

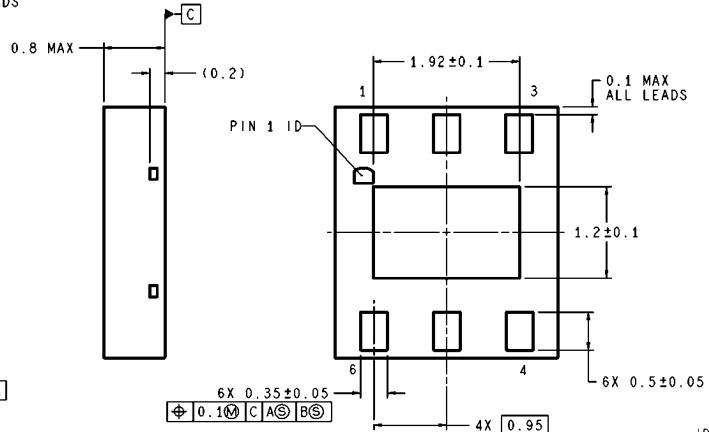
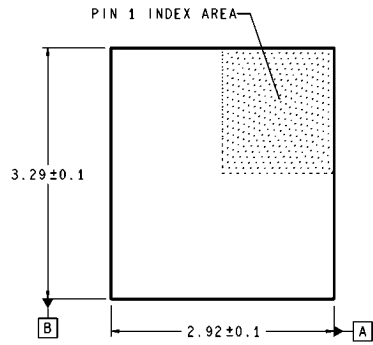

LDE06A (Rev A)

LLP, 6 Lead, Package (SOT23 Land)
NS Package Number LDE06A

Notes

LP3995

Notes

For more National Semiconductor product information and proven design tools, visit the following Web sites at:

| Products | | Design Support | |
|--------------------------------|--|-------------------------|--|
| Amplifiers | www.national.com/amplifiers | WEBENCH | www.national.com/webench |
| Audio | www.national.com/audio | Analog University | www.national.com/AU |
| Clock Conditioners | www.national.com/timing | App Notes | www.national.com/appnotes |
| Data Converters | www.national.com/adc | Distributors | www.national.com/contacts |
| Displays | www.national.com/displays | Green Compliance | www.national.com/quality/green |
| Ethernet | www.national.com/ethernet | Packaging | www.national.com/packaging |
| Interface | www.national.com/interface | Quality and Reliability | www.national.com/quality |
| LVDS | www.national.com/lvds | Reference Designs | www.national.com/refdesigns |
| Power Management | www.national.com/power | Feedback | www.national.com/feedback |
| Switching Regulators | www.national.com/switchers | | |
| LDOs | www.national.com/lido | | |
| LED Lighting | www.national.com/led | | |
| PowerWise | www.national.com/powerwise | | |
| Serial Digital Interface (SDI) | www.national.com/sdi | | |
| Temperature Sensors | www.national.com/tempsensors | | |
| Wireless (PLL/VCO) | www.national.com/wireless | | |

THE CONTENTS OF THIS DOCUMENT ARE PROVIDED IN CONNECTION WITH NATIONAL SEMICONDUCTOR CORPORATION ("NATIONAL") PRODUCTS. NATIONAL MAKES NO REPRESENTATIONS OR WARRANTIES WITH RESPECT TO THE ACCURACY OR COMPLETENESS OF THE CONTENTS OF THIS PUBLICATION AND RESERVES THE RIGHT TO MAKE CHANGES TO SPECIFICATIONS AND PRODUCT DESCRIPTIONS AT ANY TIME WITHOUT NOTICE. NO LICENSE, WHETHER EXPRESS, IMPLIED, ARISING BY ESTOPPEL OR OTHERWISE, TO ANY INTELLECTUAL PROPERTY RIGHTS IS GRANTED BY THIS DOCUMENT.

TESTING AND OTHER QUALITY CONTROLS ARE USED TO THE EXTENT NATIONAL DEEMS NECESSARY TO SUPPORT NATIONAL'S PRODUCT WARRANTY. EXCEPT WHERE MANDATED BY GOVERNMENT REQUIREMENTS, TESTING OF ALL PARAMETERS OF EACH PRODUCT IS NOT NECESSARILY PERFORMED. NATIONAL ASSUMES NO LIABILITY FOR APPLICATIONS ASSISTANCE OR BUYER PRODUCT DESIGN. BUYERS ARE RESPONSIBLE FOR THEIR PRODUCTS AND APPLICATIONS USING NATIONAL COMPONENTS. PRIOR TO USING OR DISTRIBUTING ANY PRODUCTS THAT INCLUDE NATIONAL COMPONENTS, BUYERS SHOULD PROVIDE ADEQUATE DESIGN, TESTING AND OPERATING SAFEGUARDS.

EXCEPT AS PROVIDED IN NATIONAL'S TERMS AND CONDITIONS OF SALE FOR SUCH PRODUCTS, NATIONAL ASSUMES NO LIABILITY WHATSOEVER, AND NATIONAL DISCLAIMS ANY EXPRESS OR IMPLIED WARRANTY RELATING TO THE SALE AND/OR USE OF NATIONAL PRODUCTS INCLUDING LIABILITY OR WARRANTIES RELATING TO FITNESS FOR A PARTICULAR PURPOSE, MERCHANTABILITY, OR INFRINGEMENT OF ANY PATENT, COPYRIGHT OR OTHER INTELLECTUAL PROPERTY RIGHT.

LIFE SUPPORT POLICY

NATIONAL'S PRODUCTS ARE NOT AUTHORIZED FOR USE AS CRITICAL COMPONENTS IN LIFE SUPPORT DEVICES OR SYSTEMS WITHOUT THE EXPRESS PRIOR WRITTEN APPROVAL OF THE CHIEF EXECUTIVE OFFICER AND GENERAL COUNSEL OF NATIONAL SEMICONDUCTOR CORPORATION. As used herein:

Life support devices or systems are devices which (a) are intended for surgical implant into the body, or (b) support or sustain life and whose failure to perform when properly used in accordance with instructions for use provided in the labeling can be reasonably expected to result in a significant injury to the user. A critical component is any component in a life support device or system whose failure to perform can be reasonably expected to cause the failure of the life support device or system or to affect its safety or effectiveness.

National Semiconductor and the National Semiconductor logo are registered trademarks of National Semiconductor Corporation. All other brand or product names may be trademarks or registered trademarks of their respective holders.

Copyright© 2008 National Semiconductor Corporation

For the most current product information visit us at www.national.com



**National Semiconductor
Americas Technical
Support Center**
Email:
new.feedback@nsc.com
Tel: 1-800-272-9959

**National Semiconductor Europe
Technical Support Center**
Email: europe.support@nsc.com
German Tel: +49 (0) 180 5010 771
English Tel: +44 (0) 870 850 4288

**National Semiconductor Asia
Pacific Technical Support Center**
Email: ap.support@nsc.com

**National Semiconductor Japan
Technical Support Center**
Email: jpn.feedback@nsc.com

IMPORTANT NOTICE

Texas Instruments Incorporated and its subsidiaries (TI) reserve the right to make corrections, modifications, enhancements, improvements, and other changes to its products and services at any time and to discontinue any product or service without notice. Customers should obtain the latest relevant information before placing orders and should verify that such information is current and complete. All products are sold subject to TI's terms and conditions of sale supplied at the time of order acknowledgment.

TI warrants performance of its hardware products to the specifications applicable at the time of sale in accordance with TI's standard warranty. Testing and other quality control techniques are used to the extent TI deems necessary to support this warranty. Except where mandated by government requirements, testing of all parameters of each product is not necessarily performed.

TI assumes no liability for applications assistance or customer product design. Customers are responsible for their products and applications using TI components. To minimize the risks associated with customer products and applications, customers should provide adequate design and operating safeguards.

TI does not warrant or represent that any license, either express or implied, is granted under any TI patent right, copyright, mask work right, or other TI intellectual property right relating to any combination, machine, or process in which TI products or services are used. Information published by TI regarding third-party products or services does not constitute a license from TI to use such products or services or a warranty or endorsement thereof. Use of such information may require a license from a third party under the patents or other intellectual property of the third party, or a license from TI under the patents or other intellectual property of TI.

Reproduction of TI information in TI data books or data sheets is permissible only if reproduction is without alteration and is accompanied by all associated warranties, conditions, limitations, and notices. Reproduction of this information with alteration is an unfair and deceptive business practice. TI is not responsible or liable for such altered documentation. Information of third parties may be subject to additional restrictions.

Resale of TI products or services with statements different from or beyond the parameters stated by TI for that product or service voids all express and any implied warranties for the associated TI product or service and is an unfair and deceptive business practice. TI is not responsible or liable for any such statements.

TI products are not authorized for use in safety-critical applications (such as life support) where a failure of the TI product would reasonably be expected to cause severe personal injury or death, unless officers of the parties have executed an agreement specifically governing such use. Buyers represent that they have all necessary expertise in the safety and regulatory ramifications of their applications, and acknowledge and agree that they are solely responsible for all legal, regulatory and safety-related requirements concerning their products and any use of TI products in such safety-critical applications, notwithstanding any applications-related information or support that may be provided by TI. Further, Buyers must fully indemnify TI and its representatives against any damages arising out of the use of TI products in such safety-critical applications.

TI products are neither designed nor intended for use in military/aerospace applications or environments unless the TI products are specifically designated by TI as military-grade or "enhanced plastic." Only products designated by TI as military-grade meet military specifications. Buyers acknowledge and agree that any such use of TI products which TI has not designated as military-grade is solely at the Buyer's risk, and that they are solely responsible for compliance with all legal and regulatory requirements in connection with such use.

TI products are neither designed nor intended for use in automotive applications or environments unless the specific TI products are designated by TI as compliant with ISO/TS 16949 requirements. Buyers acknowledge and agree that, if they use any non-designated products in automotive applications, TI will not be responsible for any failure to meet such requirements.

Following are URLs where you can obtain information on other Texas Instruments products and application solutions:

Products

| | |
|------------------------|--|
| Audio | www.ti.com/audio |
| Amplifiers | amplifier.ti.com |
| Data Converters | dataconverter.ti.com |
| DLP® Products | www.dlp.com |
| DSP | dsp.ti.com |
| Clocks and Timers | www.ti.com/clocks |
| Interface | interface.ti.com |
| Logic | logic.ti.com |
| Power Mgmt | power.ti.com |
| Microcontrollers | microcontroller.ti.com |
| RFID | www.ti-rfid.com |
| OMAP Mobile Processors | www.ti.com/omap |
| Wireless Connectivity | www.ti.com/wirelessconnectivity |

Applications

| | |
|-------------------------------|--|
| Communications and Telecom | www.ti.com/communications |
| Computers and Peripherals | www.ti.com/computers |
| Consumer Electronics | www.ti.com/consumer-apps |
| Energy and Lighting | www.ti.com/energy |
| Industrial | www.ti.com/industrial |
| Medical | www.ti.com/medical |
| Security | www.ti.com/security |
| Space, Avionics and Defense | www.ti.com/space-avionics-defense |
| Transportation and Automotive | www.ti.com/automotive |
| Video and Imaging | www.ti.com/video |

TI E2E Community Home Page

e2e.ti.com

Mailing Address: Texas Instruments, Post Office Box 655303, Dallas, Texas 75265
Copyright © 2011, Texas Instruments Incorporated