

Two-Wire, Differential, Vibration-Resistant Sensor IC with Speed and Direction Output

Datasheet Addendum

Package: 2-Pin SIP (Suffix UB)

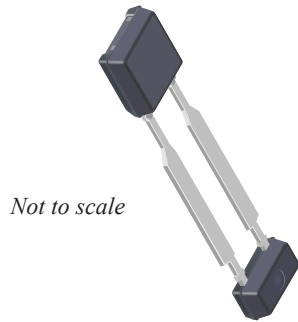

DESCRIPTION

This addendum adds an alternate output pulse width (Intermediate “T”) and protocol variant to the existing datasheet.

For parameters not listed within this addendum, refer to the A1699 datasheet. In the event of a conflict between this addendum and the main datasheet, this addendum takes precedence.

Complete Part Number Format

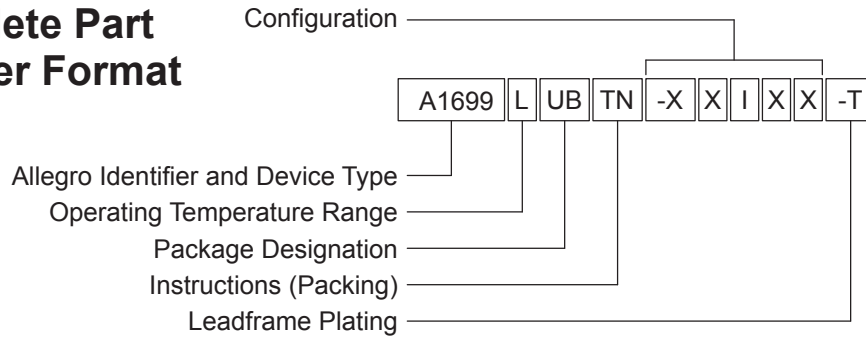

Allegro Identifier and Device Type	[A1699]	
Operating Temperature Range	[L]	
Package Designation	[UB] 2-pin plastic SIP	
Instructions (Packing)	[TN] Tape and reel	
Configuration	Rotation Direction	[-F] pin 1-to-2 forward or [-R] pin 2-to-1 forward
	Number of Pulses	[S] single, one pulse per magnetic pole pair or [D] dual, one pulse for each north and south pole
	Pulse Widths (typ)	[I] (Intermediate) Forward = 60 μ s, Reverse = 120 μ s, Speed = 30 μ s
	Running Mode SPD Pulses (low frequency)	[B] Blanked, no low-frequency SPD pulses [P] Pulses permitted during running mode
	Vibration Immunity / Direction Change	[L] Low vibration immunity with immediate direction change detection or [H] High vibration immunity
Leadframe Plating	[T] Lead (Pb) free	

For example: A1699LUBTN-RSIBL-T

Where a configuration character is unspecified, “x” will be used. For example, -xSIBL applies to both Rotation Direction configuration variants.

SELECTION GUIDE

Part Number	Packing*
A1699LUBTN-FSIBH-T	4000 pieces per 13-in. reel
A1699LUBTN-RSIBH-T	



*Not all combinations are available. Contact Allegro sales for availability and pricing of custom programming options.

OPERATING CHARACTERISTICS: Valid throughout full operating and temperature ranges, unless otherwise noted

Characteristic	Symbol	Test Conditions	Min.	Typ.	Max.	Unit
ELECTRICAL CHARACTERISTICS						
Supply Current	$I_{CC(LOW)}$	Low-current state (running mode)	5.9	–	8.4	mA
	$I_{CC(HIGH)}$	High-current state	11.8	–	16.8	mA
	$I_{CC(SU)(LOW)}$	Low-current level (calibration) and Power-on mode	5.9	–	8.5	mA
Supply Current Ratio	$\frac{I_{CC(HIGH)}}{I_{CC(LOW)}}$	Low-current state (running mode)	1.9	–	–	–
OUTPUT PULSE CHARACTERISTICS						
Pulse Width, Forward Rotation	$t_{w(FWD)}$	-xxlxx variant	51	60	69	μ s
Pulse Width, Reverse Rotation	$t_{w(REV)}$	-xxlxx variant	102	120	138	μ s
Pulse Width, Speed Only	$t_{w(SPD)}$	-xxlxx variant	25	30	35	μ s
Pulse Pre-Low Length	$t_{w(PRE)}$	-xxlxx variant	25	30	35	μ s
OPERATING CHARACTERISTICS						
Transition Frequency Between Direction Pulses and Speed Pulses	f_{DIR}	Detection point, increasing frequency	–	1100	–	Hz
		Detection point, decreasing frequency	–	1000	–	Hz

Output Pulse Timing

With an -xxlxx variant, each output pulse begins with a defined time duration of $I_{CC(LOW)}$ of $t_{w(PRE)}$ (typical 30 μ s).

Direction Validation

For the -xxxxL variant, following a direction change in running mode, direction changes are immediately transmitted to the output.

For the -xxxPH variant, following a direction change in running mode, output pulses have a width of $t_{w(SPD)}$ until direction information is validated. Using the -xxxBH variant suppresses running-mode SPD pulses below f_{SPD} .

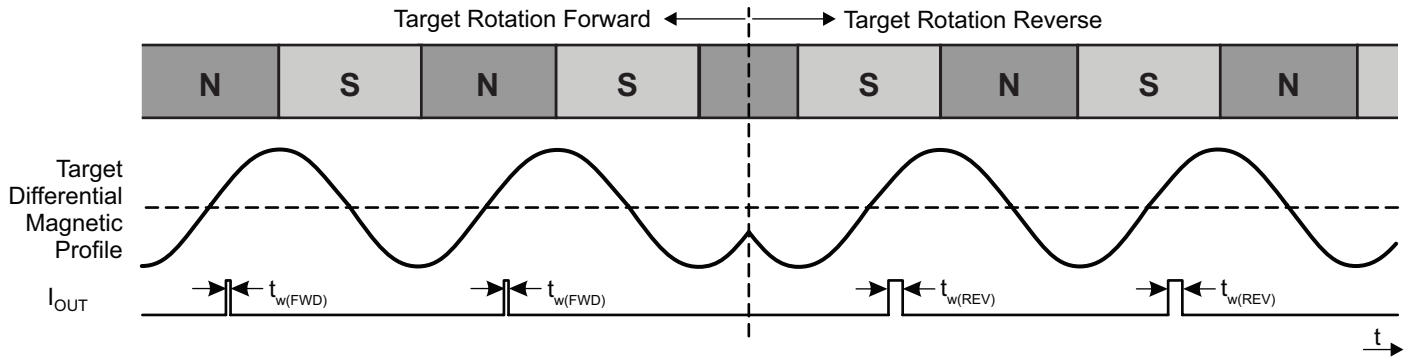

Figure 1: Example Running Mode Direction Change (-FSxxL variant)

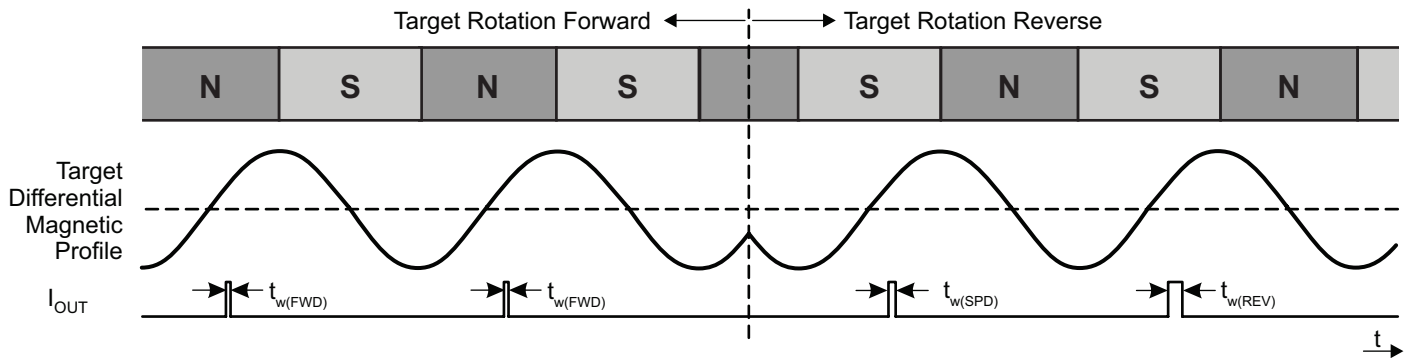

Figure 2: Example Running Mode Direction Change (-FSxPH variant)

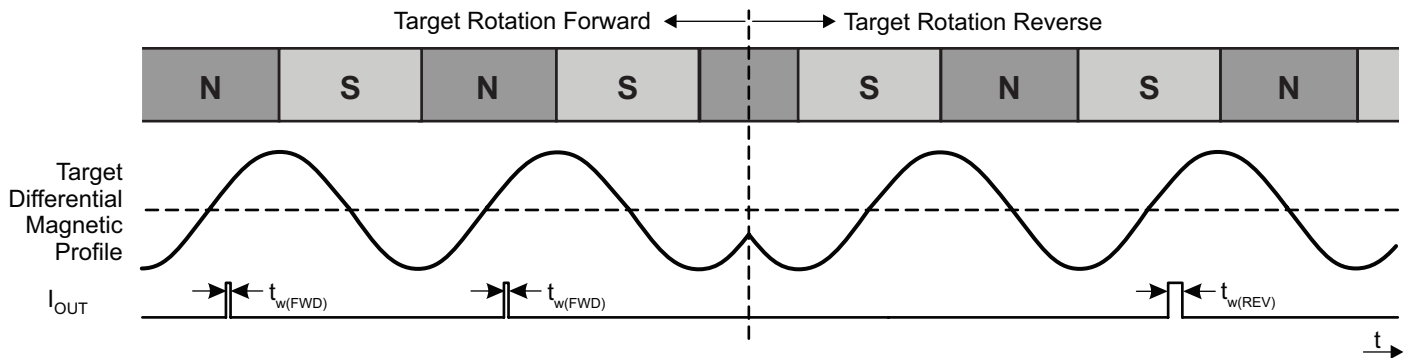

Figure 3: Example Running Mode Direction Change (-FSxBH variant)

Startup Detection/Calibration

When power is applied to the A1699, the sensor IC internally detects the profile of the target. The gain and offset of the detected signals are adjusted during the calibration period, normalizing the internal signal amplitude for the air gap range of the device.

Direction information is available after calibration is complete.

For the -xxlxx variant, output pulses of $t_{W(SP)}$ are supplied during calibration. Figure 4 shows where the first output edges may occur for various starting target phases.

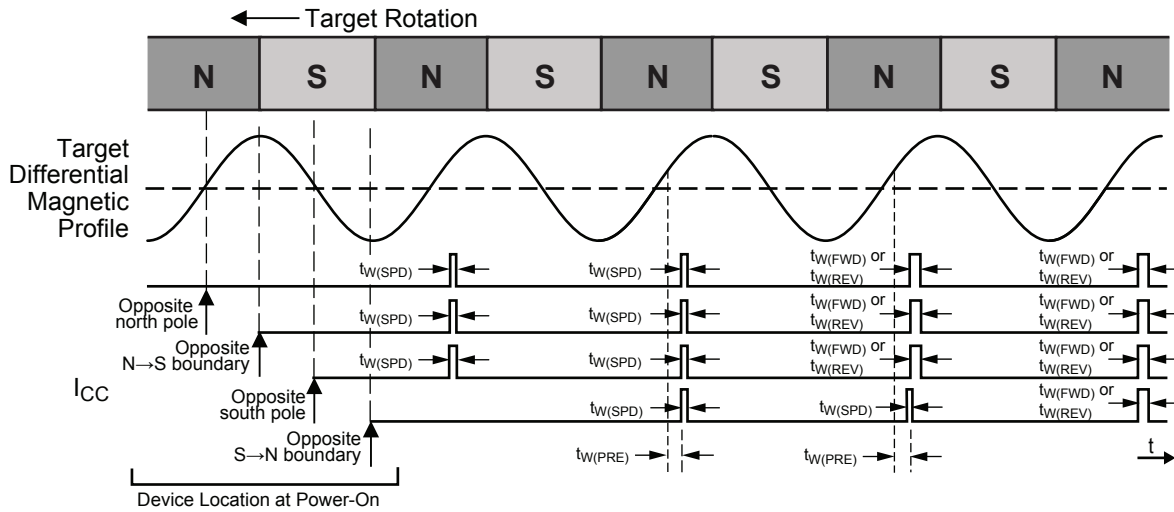

Figure 4: Startup Position Effect on First Device Output Switching (-xxlxx variant)

Vibration Detection

Algorithms embedded in the IC’s digital controller detect the presence of target vibration through analysis of the two magnetic input channels.

For the -xxxxL variant, the first direction change is immediately transmitted to the output. During any subsequent vibration, the output is blanked and no output pulses will occur for vibrations less than the specified vibration immunity. Output pulses containing the proper direction information will resume when direction information is validated on constant target rotation.

For the -xxxPH variant, in the presence of vibration, output pulses of $t_{w(SPD)}$ may occur or no pulses may occur, depending on the amplitude and phase of the vibration. Output pulses have a width of $t_{w(SPD)}$ until direction information is validated on constant target rotation.

Speed Pulses

Above f_{DIR} , output pulses will be of $t_{w(SPD)}$ duration only.

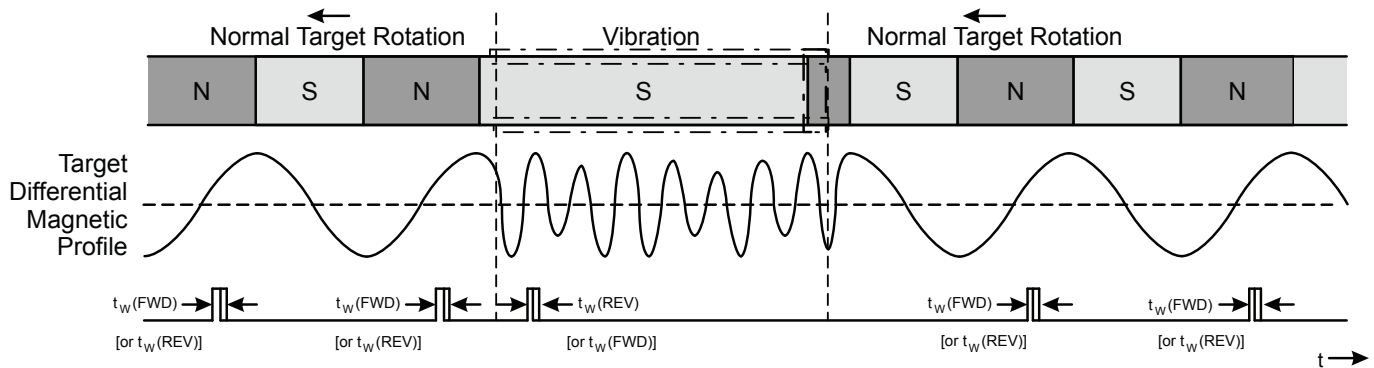

Figure 5: Output Functionality in the Presence of Running Mode Target Vibration (-xxxxL variant)

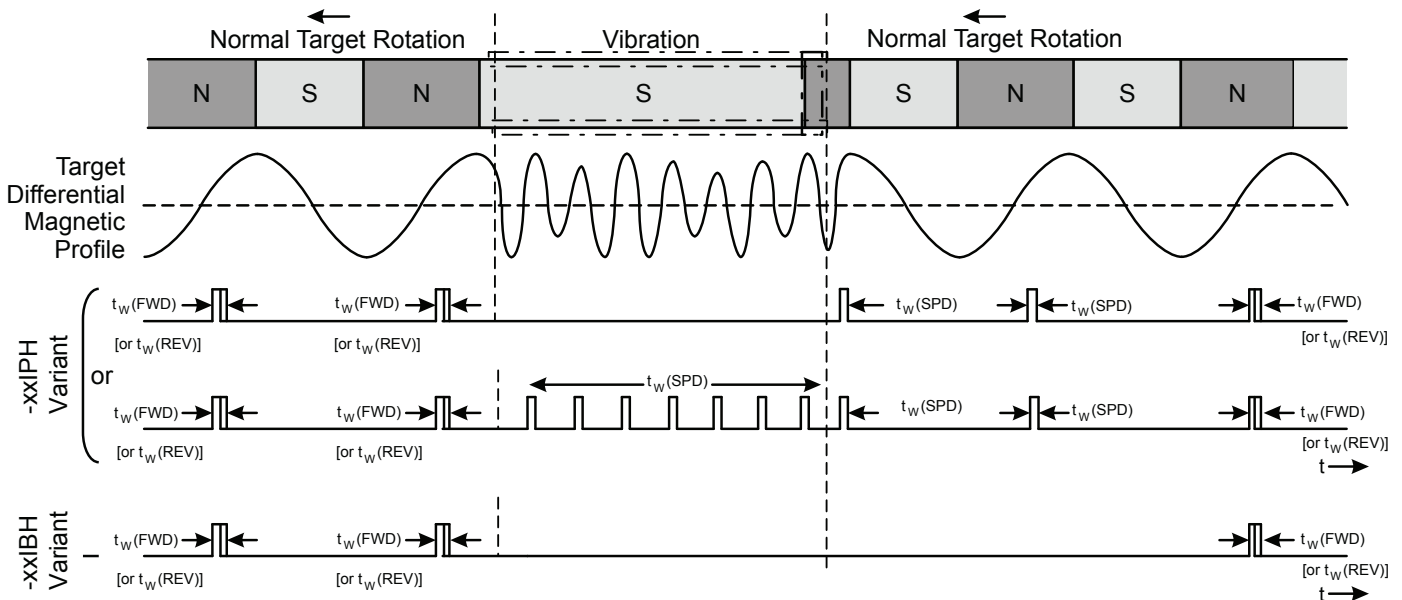

Figure 6: Output Functionality in the Presence of Running Mode Target Vibration (-xxxxH variants)

Revision History

Number	Date	Description
–	February 17, 2017	Initial release

Copyright ©2017, Allegro MicroSystems, LLC

Allegro MicroSystems, LLC reserves the right to make, from time to time, such departures from the detail specifications as may be required to permit improvements in the performance, reliability, or manufacturability of its products. Before placing an order, the user is cautioned to verify that the information being relied upon is current.

Allegro's products are not to be used in any devices or systems, including but not limited to life support devices or systems, in which a failure of Allegro's product can reasonably be expected to cause bodily harm.

The information included herein is believed to be accurate and reliable. However, Allegro MicroSystems, LLC assumes no responsibility for its use; nor for any infringement of patents or other rights of third parties which may result from its use.

For the latest version of this document, visit our website:

www.allegromicro.com

