

nRF52840 Dongle PCA10059 v1.0.0

User Guide

v1.1

Contents

| | | |
|----------|---|-----------|
| | Revision history | iii |
| 1 | Introduction | 4 |
| 2 | Minimum requirements | 5 |
| 3 | Kit content | 6 |
| | 3.1 Hardware content | 6 |
| | 3.2 Downloadable content | 6 |
| | 3.3 Related documentation | 7 |
| 4 | Getting started | 8 |
| 5 | Programming | 9 |
| 6 | Hardware description | 10 |
| | 6.1 Hardware drawings | 10 |
| | 6.2 Block diagram | 10 |
| | 6.3 Power supply | 11 |
| | 6.3.1 Internal regulator | 11 |
| | 6.3.2 External regulated source | 12 |
| | 6.4 Buttons and LEDs | 12 |
| | 6.5 32.768 kHz crystal | 13 |
| | 6.6 USB | 13 |
| | 6.7 SWD interface | 14 |
| | 6.8 External connections | 14 |
| | Legal notices | 15 |

Revision history

| Date | Version | Description |
|--------------|---------|---|
| January 2019 | 1.1 | Updated Getting started on page 8 |
| June 2018 | 1.0 | First release |

1 Introduction

The nRF52840 Dongle (PCA10059) is the preferred hardware to be used with the nRF Connect for Desktop software package to develop and test your nRF-based wireless solutions. The hardware supports all the short range wireless standards available on the nRF52 family of devices, and the built-in USB device controller provides a high data throughput communication interface.

The nRF52840 Dongle can also be used together with the nRF5 SDK for product development based on the the nRF52840 SoC.

The nRF52840 Dongle is a low-cost, versatile USB development dongle for *Bluetooth*[®] Low Energy, ANT[™], 802.15.4, and user-proprietary 2.4 GHz applications using the nRF52840 SoC.

Key features:

- nRF52840 flash-based ANT/ANT+[™], Bluetooth Low Energy SoC solution
- Button and LEDs for user interaction
- 15 GPIO available on a castellated edge
- Onboard USB bootloader with buttonless support
- USB support



Environmental Protection

Waste electrical products should not be disposed of with household waste.

Please recycle where facilities exist. Check with your local authority or retailer for recycling advice.

2 Minimum requirements

Before you start, check that you have the required hardware and software.

Hardware requirements

- PC with a standard type-A USB port

Software requirements

- [nRF Connect for Desktop](#)
- Operating system: macOS, Linux, or Windows 7 or later

3 Kit content

The nRF52840 Dongle consists of hardware (PCA10059), access to application firmware examples, documentation, hardware schematics, and layout files.

3.1 Hardware content

The nRF52840 Dongle hardware consists of the board (PCA10059).

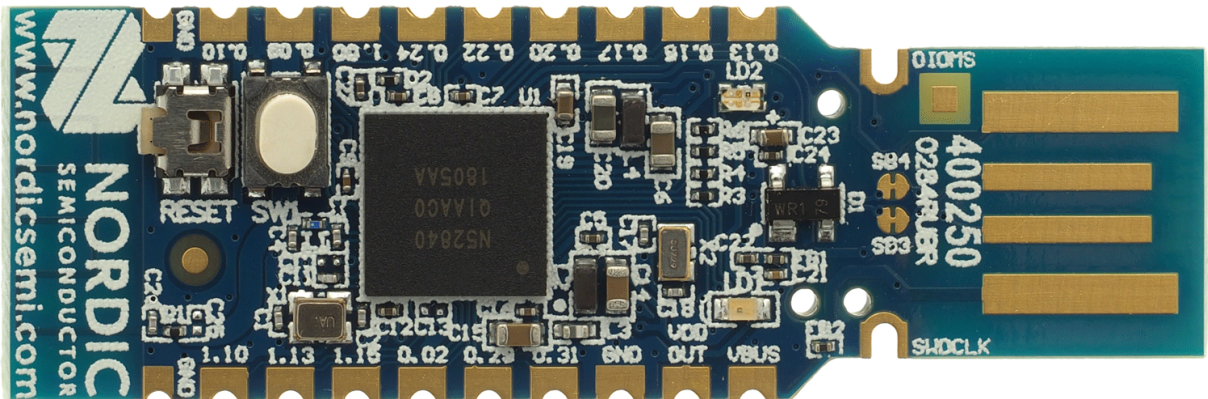

Figure 1: nRF52840 Dongle hardware (PCA10059) front

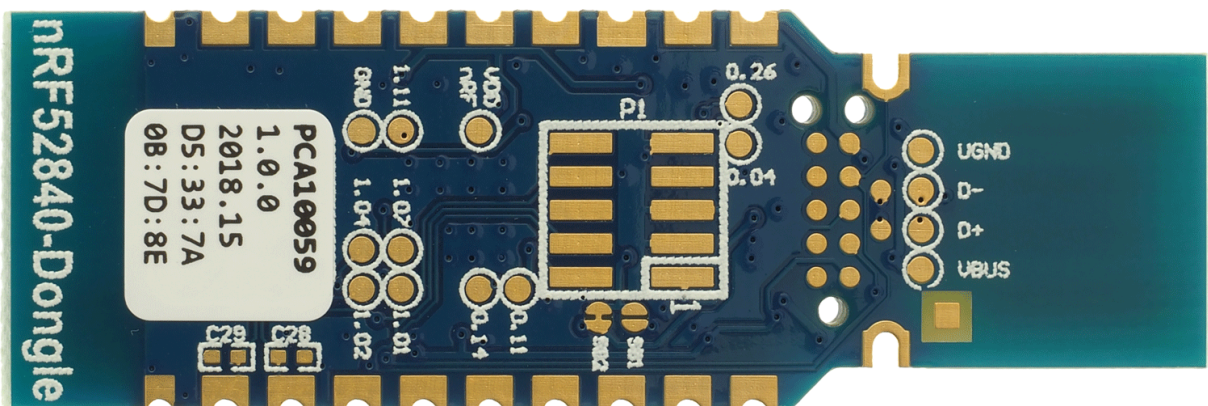

Figure 2: nRF52840 Dongle hardware (PCA10059) back

The sticker on the back side of the nRF52840 Dongle contains the following information:

- Board number (PCA10059)
- Hardware revision
- Production year and week (YYYY.WK)
- MAC address/serial number

3.2 Downloadable content

The nRF52840 Dongle downloadable content consists of a software tool, application firmware examples, and hardware files.

Software

- [nRF Connect for Desktop](#)

Firmware package

In the [nRF5 SDK](#), you can find precompiled application firmware examples.

Hardware files

Schematics, layout, bill of materials, and Gerber files for nRF52840 Dongle (PCA10059) are included in a zip file:

- [nRF52840 Dongle Hardware Files](#)

3.3 Related documentation

In addition to the information in this document, you may need to consult other documents.

Nordic documentation

- [nRF52840 Product Specification](#)
- [nRF52840 Errata](#)
- [nRF52840 Compatibility Matrix](#)
- [nRF52840 Development Kit User Guide](#)
- [nRF Connect for Desktop](#)
- [nRF5 SDK v17.1.0](#)

4 Getting started

Complete a few steps to set up the hardware and install the required software.

Before you start, check [Minimum requirements](#) on page 5.

Connect the Dongle to a computer and get started with nRF Connect for Desktop.

1. Download and install [nRF Connect for Desktop](#).

This includes the driver for the nRF52840 USB Device Firmware Upgrade (DFU) feature. For documentation on the tool, see [nRF Connect for Desktop](#).

2. Insert the nRF52840 Dongle in a USB port on your computer.

The status light (LD2) starts pulsing red, indicating that the Dongle is powered up and is in bootloader mode. After a few seconds, the computer will recognize the Dongle as a USB composite device. The driver needed for the nRF52840 USB DFU feature is also installed.

3. Optional: Download the [nRF5 SDK](#).

nRF5 SDK contains application examples for the Dongle. For documentation, see [nRF5 SDK v17.1.0](#).

4. Optional: Download [SEGGER Embedded Studio \(SES\)](#).

SES is needed for building application examples for the Dongle. It can be used free of charge with nRF devices.

5. Optional: Install [nRF Util](#).

nrfutil can be used for programming the Dongle from the command line.

6. Open an nRF Connect for Desktop app and select the serial number of the nRF52840 Dongle as the target.

Applications that support the nRF52840 Dongle will display the serial numbers of any connected Dongles in the device drop-down list.

If the app supports the Dongle but the correct firmware is missing, you will be asked to confirm that you want to have the Dongle programmed. Click **OK**.

If the Dongle contains the correct firmware, the app will start immediately.

For further information on programming the nRF52840 Dongle, see [Nordic Developer Zone](#).

5 Programming

The nRF52840 Dongle can be programmed through the built-in USB bootloader.

Before you start, check [Getting started](#) on page 8.

To program the Dongle, it must be in bootloader mode.

The Dongle can be made to enter bootloader mode in one of the two ways:

- Trigger the nRF52840 USB DFU endpoint.

The firmware to support this is embedded in all nRF Connect for Desktop apps for the nRF52840 Dongle. If you add the DFU Trigger Library (USB) to your custom device firmware, you will be able to trigger the DFU from nRF Connect for Desktop without using any buttons. For documentation, see [DFU Trigger Library \(USB\)](#), which is part of the [nRF5 SDK v17.1.0](#).

- For Dongles with applications missing the USB DFU endpoint: Press the RESET button.

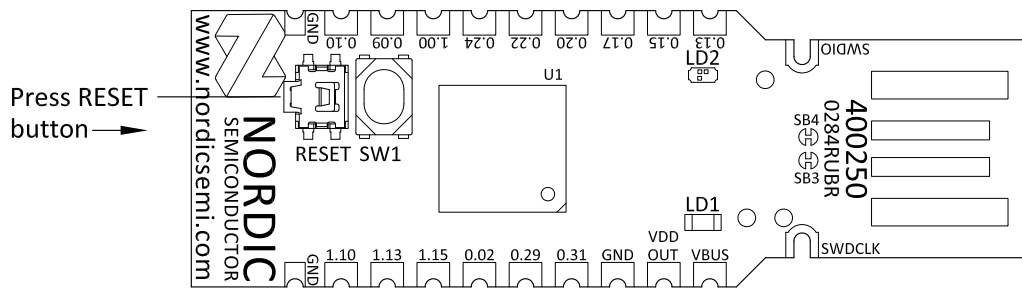

When the nRF52840 Dongle has entered the bootloader mode, **LD2** pulses red. The Dongle is now ready for programming.

All the nRF Connect for Desktop apps require specific firmware to be present on the nRF52840 Dongle to function correctly. The apps will update the firmware if needed. If you want to upload a custom firmware to the Dongle, you can do this by using the dedicated Programmer programming app, or nrfutil.

6 Hardware description

The nRF52840 Dongle can be used as a development platform for the nRF52840 SoC. It features user configurable LEDs and a button as well as multiple GPIOs available along the board edges. In addition to radio communication, the nRF52840 SoC can communicate with a computer through USB.

6.1 Hardware drawings

The nRF52840 Dongle hardware drawings show both sides of the PCA10059 board.

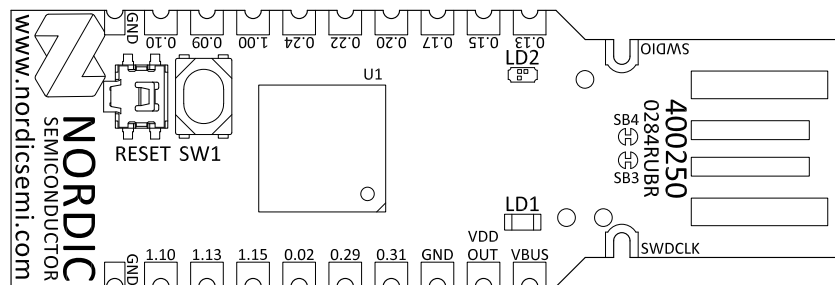

Figure 3: nRF52840 Dongle (PCA10059) front view

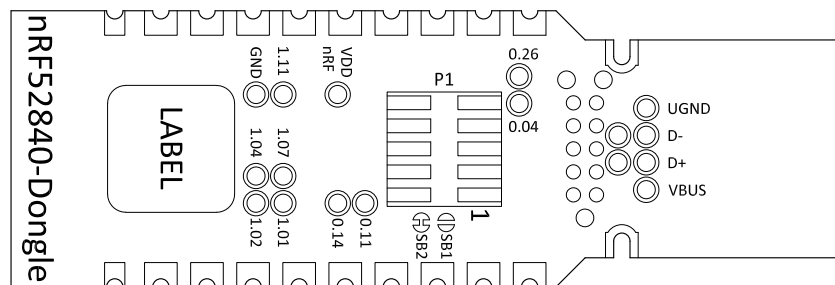

Figure 4: nRF52840 Dongle (PCA10059) back view

6.2 Block diagram

The block diagram illustrates the nRF52840 Dongle functional architecture.

| Part | Description | GPIO |
|------|-------------|--------------------|
| SW1 | Button | P1.06 |
| SW2 | Reset | P0.18 ¹ |
| LD1 | Green | P0.06 |
| LD2 | Red | P0.08 |
| LD2 | Green | P1.09 |
| LD2 | Blue | P0.12 |

Table 1: LED connections

The buttons are active low, which means that the input will be connected to ground when the button is activated. The **SW1** button has no external pull-up resistor, but the reset button (**SW2**) has a 10 k pull-up resistor. To use **SW1**, **P1.06** must be configured as an input with an internal pull-up resistor.

The LEDs are active low, which means that writing a logical zero '0' to the output pin will illuminate the LED.

6.5 32.768 kHz crystal

The nRF52840 Dongle is equipped with a 32.768 kHz crystal (**X2**) for high accuracy and low average power consumption.

Note: The 32.768 kHz crystal (**X2**) is required for correct operation when using ANT/ANT+.

6.6 USB

The nRF52840 Dongle features a USB-A-type connector printed on the circuit board.

Additional test points for the USB data lines are available on the bottom side of the circuit board if the nRF52840 Dongle is used as a module on a motherboard with a USB connector. To disconnect data lines from the onboard USB connector, cut solder bridges **SB3** and **SB4**.

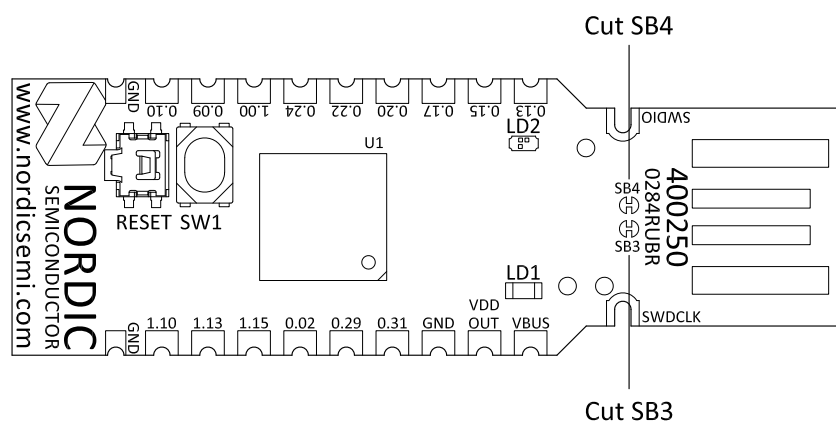

Figure 9: Disconnecting USB data lines

¹ **SW2** is also connected to **P0.19**, **P0.21**, **P0.23**, and **P0.25**. This is done to simplify PCB routing. These GPIOs should not be used and should be left as input with no pull or be disconnected by firmware.

6.7 SWD interface

On the back side of the nRF52840 Dongle, there are connection points for the SWD interface.

The dongle is equipped with a footprint for two different connectors. On footprint **P1**, a standard 2×5-pin header with a 1.27 mm pitch can be soldered. On footprint **J2**, it is possible to connect a TC2050 cable from Tag-Connect.

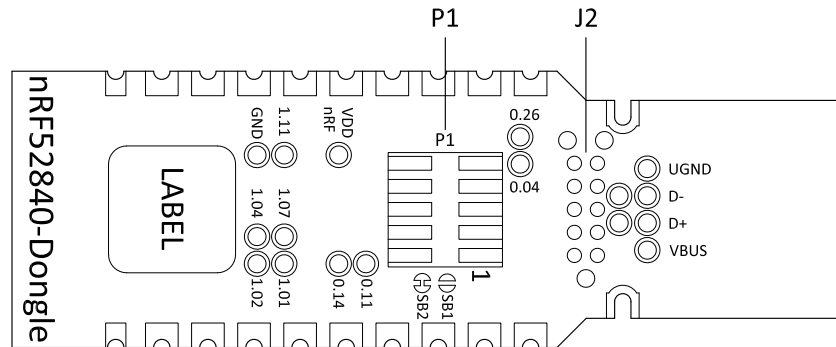

Figure 10: SWD interface connectors

For instance, a Nordic development kit can be used as a programmer for the Dongle.

6.8 External connections

The nRF52840 Dongle has 15 GPIOs in addition to the ground, power, and SWD connections along the castellated edges.

The castellated edge holes have a pitch of 0.1 inches (2.54 mm) and a row spacing of 0.6 inches (15.24 mm)², making it suitable for stripboard connection. Test points for additional nine GPIOs are available on the back side of the circuit board, leaving a total of 24 GPIOs accessible.

Note: There is no reverse voltage protection on the power connections.

² The SWD connections are located 0.2 inches (5.08 mm) away from the GPIOs with a row spacing of 0.4 inches (10.16 mm)

Legal notices

By using this documentation you agree to our terms and conditions of use. Nordic Semiconductor may change these terms and conditions at any time without notice.

Liability disclaimer

Nordic Semiconductor ASA reserves the right to make changes without further notice to the product to improve reliability, function, or design. Nordic Semiconductor ASA does not assume any liability arising out of the application or use of any product or circuits described herein.

Nordic Semiconductor ASA does not give any representations or warranties, expressed or implied, as to the accuracy or completeness of such information and shall have no liability for the consequences of use of such information. If there are any discrepancies, ambiguities or conflicts in Nordic Semiconductor's documentation, the Product Specification prevails.

Nordic Semiconductor ASA reserves the right to make corrections, enhancements, and other changes to this document without notice.

Life support applications

Nordic Semiconductor products are not designed for use in life support appliances, devices, or systems where malfunction of these products can reasonably be expected to result in personal injury.

Nordic Semiconductor ASA customers using or selling these products for use in such applications do so at their own risk and agree to fully indemnify Nordic Semiconductor ASA for any damages resulting from such improper use or sale.

RoHS and REACH statement

Complete hazardous substance reports, material composition reports and latest version of Nordic's REACH statement can be found on our website www.nordicsemi.com.

Trademarks

All trademarks, service marks, trade names, product names, and logos appearing in this documentation are the property of their respective owners.

Copyright notice

© 2022 Nordic Semiconductor ASA. All rights are reserved. Reproduction in whole or in part is prohibited without the prior written permission of the copyright holder.

