

1-stage filter for 3-phase systems with neutral conductor

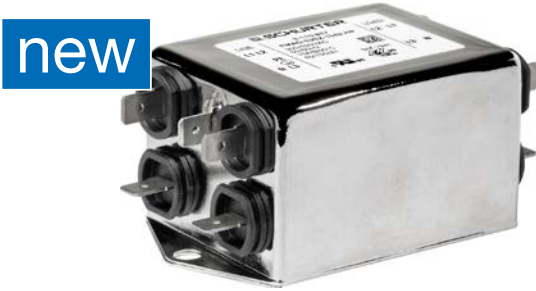

See below:

Approvals and Compliances

Description

- Line filter as standard, industrial and medical version
- 1 stage
- Filter with standard or high attenuation (HP)

Unique Selling Proposition

- Compact single-stage filter
- Various filter variants
- Light weight design
- Wide temperature range

Applications

- Voltage rating 520 VAC for world wide acceptance
- For low power 3 phase energy inverter such as photovoltaic or battery storage systems
- Suitable for use in equipment according to IEC/UL 62368-1

Weblinks

[pdf data sheet](#), [html datasheet](#), [General Product Information](#), [Approvals](#), [Distributor-Stock-Check](#), [Detailed request for product](#), [Microsite](#)

Technical Data

Rated Current	3 - 20A
Rated voltage	300/520VAC, 50/60 Hz
Approval for	3 - 20A @ 50 °C / 300/520VAC; 50/60Hz
Overload Current	1.5 x Ir for 1 minute, per hour
Dielectric Strength	> 2.25kVDC between L-L > 1.3kVDC between L-N 2.75kVDC between L-PE Test voltage 2 sec
Number of Filter Stages	1-stage
Weight	0.2
Material: Housing	Metal
Sealing Compound	UL 94V-0

Mounting	Screw-on mounting on chassis
Terminal	Screw clamps
Operating Temperature	-40°C to 100°C
Climatic Category	40/100/21 acc. to IEC 60068-1
Degree of Protection	IP20 acc. to IEC 60529
Protection Class	Suitable for appliances with protection class I acc. to IEC 61140
MTBF	> 200'000h acc. to MIL-HB-217 F

Approvals and Compliances

Detailed information on product approvals, code requirements, usage instructions and detailed test conditions can be looked up in [Details about Approvals](#)

SCHURTER products are designed for use in industrial environments. They have approvals from independent testing bodies according to national and international standards. Products with specific characteristics and requirements such as required in the automotive sector according to IATF 16949, medical technology according to ISO 13485 or in the aerospace industry can be offered exclusively with customer-specific, individual agreements by SCHURTER.

Approvals

The approval mark is used by the testing authorities to certify compliance with the safety requirements placed on electronic products.

Approval Reference Type: FMAD CP

Approval Logo	Certificates	Certification Body	Description
	VDE Approvals	VDE	Certificate Number: 40050745
	UL Approvals	UL	UR File Number: E495089

Product standards

Product standards that are referenced

Organization	Design	Standard	Description
	Designed according to	IEC 60939	Passive filters for suppressing electromagnetic interference
	Designed according to	UL 60939-3	Electromagnetic interference filters





Application standards

Application standards where the product can be used

Organization	Design	Standard	Description
	Suitable for applications acc.	IEC/UL 62368-1	Audio/video, information and communication technology equipment - Part 1: Safety requirements

Compliances

The product complies with following Guide Lines

Identification	Details	Initiator	Description
	CE declaration of conformity	SCHURTER AG	The CE marking declares that the product complies with the applicable requirements laid down in the harmonisation of Community legislation on its affixing in accordance with EU Regulation 765/2008.
	UKCA declaration of conformity	SCHURTER AG	The UKCA marking declares that the product complies with the applicable requirements laid down in the British Amendment of Regulation (EC) 765/2008.
	RoHS	SCHURTER AG	Directive RoHS 2011/65/EU, Amendment (EU) 2015/863
	China RoHS	SCHURTER AG	The law SJ / T 11363-2006 (China RoHS) has been in force since 1 March 2007. It is similar to the EU directive RoHS.
	REACH	SCHURTER AG	On 1 June 2007, Regulation (EC) No 1907/2006 on the Registration, Evaluation, Authorization and Restriction of Chemicals 1 (abbreviated as "REACH") entered into force.

Dimension [mm]

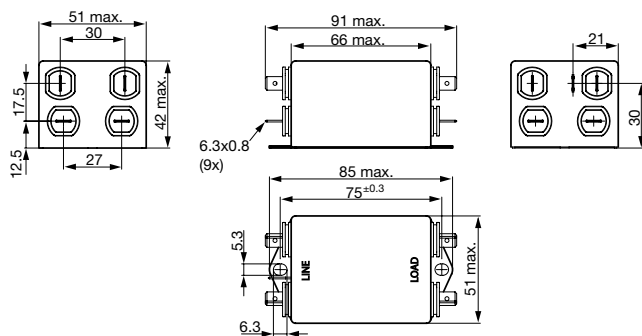

Diagrams

Medical Version (M5)

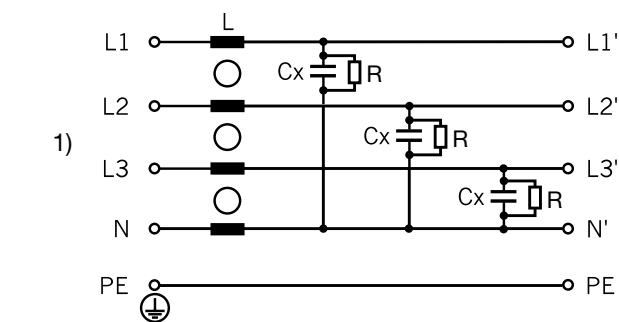

1) Line

Standard, Industrial version

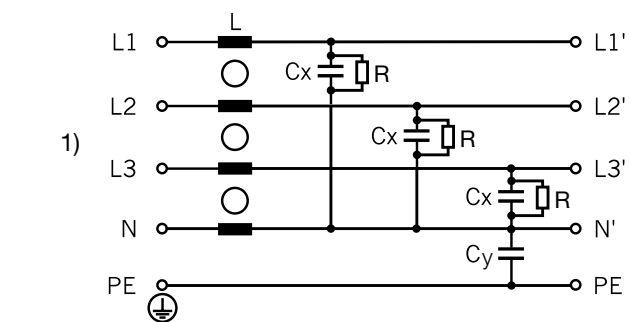

1) Line

Attenuation Loss

--- 50Ω differential mode ___ 50Ω common mode

Standard version

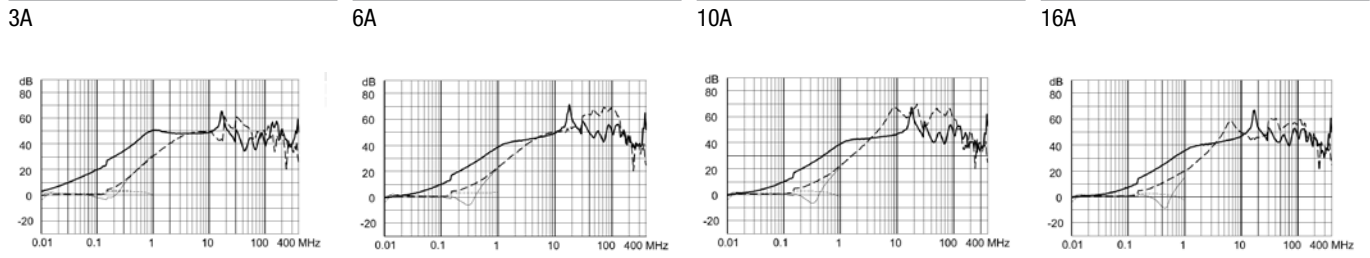

20A

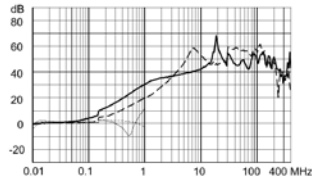

Industrial version

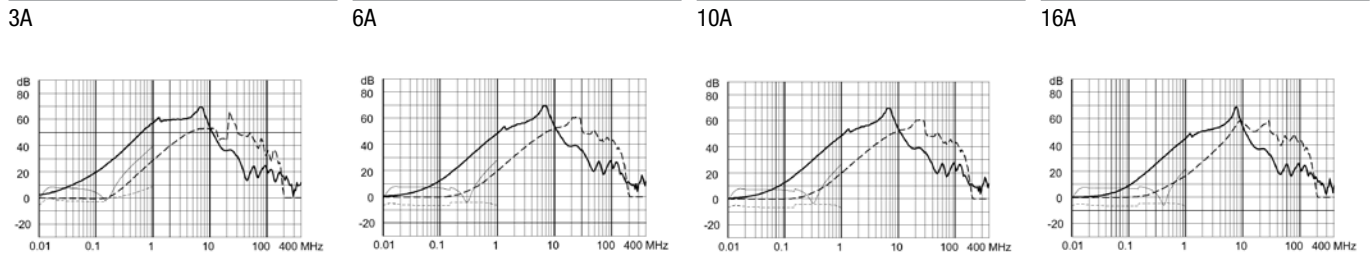

20A

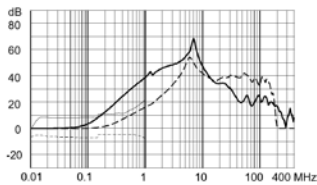

Medical version (M5)

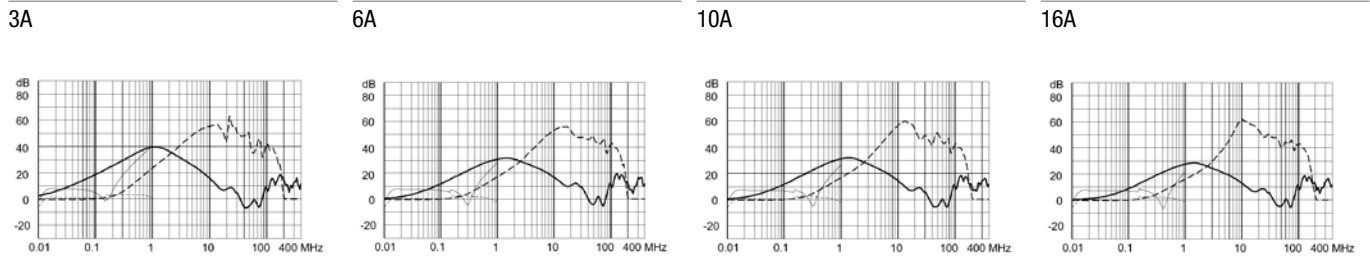

20A

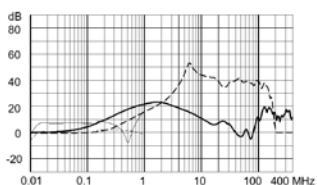

Standard HP

3A

6A

10A

16A

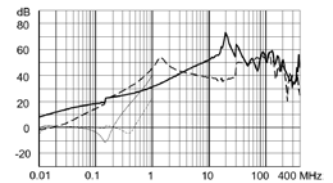
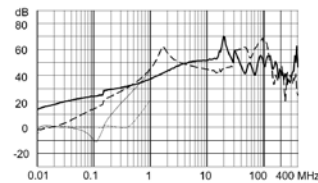
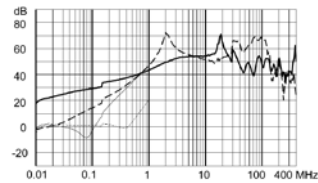
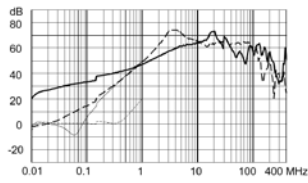

20A

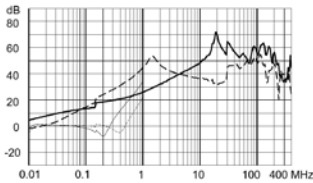

Industry HP

3A

6A

10A

16A

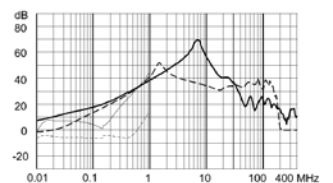
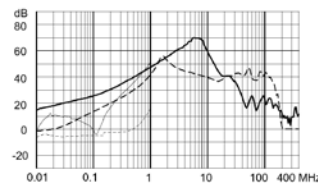
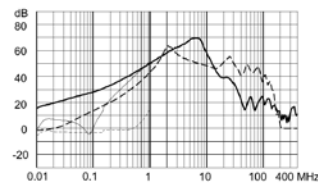
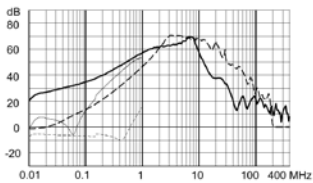

20A

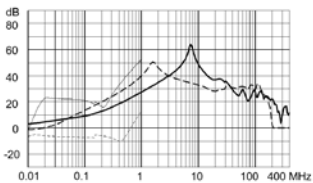

Medical (M5) HP

3A

6A

10A

16A

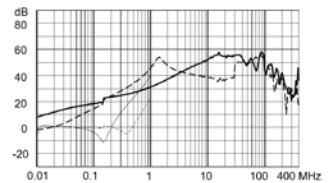
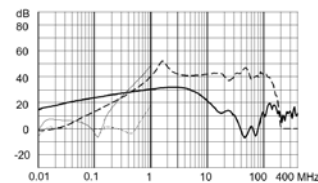
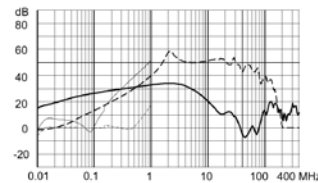
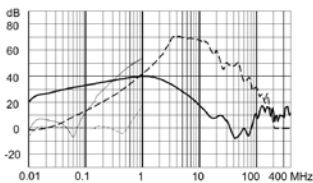

20A

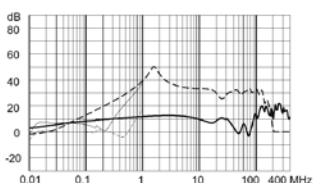

All Variants

Rated Current @ Ta 50°C [A]	Filter Type	Tripped Power Dissipation [W]	Contact Resi- stance [mΩ]	Leakage Current [mA] @ 440V, 60Hz 1)	Order Number
3	Industrial version	2.8	78.9	3	3-110-821
3	Industrial version HP	2.3	63.6	3	3-110-843
3	Medical Version (M5)	2.8	78.9	0.005	3-110-817
3	Medical Version (M5) HP	2.3	63.6	0.005	3-110-839
3	Standard version	2.8	78.9	0.5	3-110-813
3	Standard version HP	2.3	63.6	0.5	3-110-835
6	Industrial version	1.9	13	3	3-110-832
6	Industrial version HP	2.2	15.3	3	3-110-844
6	Medical Version (M5)	1.9	13	0.005	3-110-818
6	Medical Version (M5) HP	2.2	15.3	0.005	3-110-840
6	Standard version	1.9	13	0.5	3-110-814
6	Standard version HP	2.2	15.3	0.5	3-110-836
10	Industrial version	2.8	6.9	3	3-110-833
10	Industrial version HP	2.5	6.2	3	3-110-845
10	Medical Version (M5)	2.8	6.9	0.005	3-110-819
10	Medical Version (M5) HP	2.5	6.2	0.005	3-110-841
10	Standard version	2.8	6.9	0.5	3-110-815
10	Standard version HP	2.5	6.2	0.5	3-110-837
16	Industrial version	3.6	3.5	3	3-111-516
16	Industrial version HP	2.8	2.7	3	3-111-519
16	Medical Version (M5)	3.6	3.5	0.005	3-111-515
16	Medical Version (M5) HP	2.8	2.7	0.005	3-111-518
16	Standard version	3.6	3.5	0.5	3-111-514
16	Standard version HP	2.8	2.7	0.5	3-111-517
20	Industrial version	3.5	2.2	3	3-110-834
20	Industrial version HP	2.5	1.5	3	3-110-846
20	Medical Version (M5)	3.5	2.2	0.005	3-110-820
20	Medical Version (M5) HP	2.5	1.5	0.005	3-110-842
20	Standard version	3.5	2.2	0.5	3-110-816
20	Standard version HP	2.5	1.5	0.5	3-110-838

Availability for all products can be searched real-time: <https://www.schurter.com/en/Stock-Check/Stock-Check-SCHURTER>

Packaging unit

10 Pcs

Zubehör

Description



DIN Rail Kit
 Mounting accessory for compact 1- and 3-phase filters