

Low Voltage Comparator

FAN156



SIP6 1.45x1.0
 CASE 127EB

Description

The FAN156 is a low-power single comparator that typically consumes less than 10 μA of supply current. It is guaranteed to operate at a low voltage of 1.6 V and is fully operational up to 5.5 V, making it convenient for use in 1.8, 3.0 V, and 5.0 V systems.

The FAN156 has a complementary push-pull P- and N-channel output stage capable of driving a rail-to-rail output swing with a load ranging up to 5.0 mA.

Features

- Low Supply Current: I_{DD} 6 μA (Typical)
- Single Power Supply Operation
- Wide Common-Mode Input Voltage Range
- Push-Pull Output Circuit
- Low Input Bias Current
- Internal Hysteresis
- Packaged in MicroPak™ 6
- This is a Pb-Free Device

Applications

- Mobile Phones
- Alarm and Security Systems
- Personal Digital Assistants

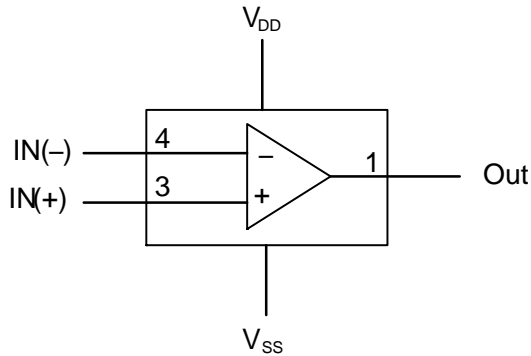
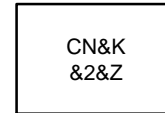

Figure 1. Functional Diagram

MARKING DIAGRAM



CN = Specific Device Code
 &K = 2-Digits Lot Run Traceability Code
 &2 = 2-Digit Date Code
 &Z = Assembly Plant Code

ORDERING INFORMATION

See detailed ordering and shipping information on page 7 of this data sheet.

FAN156

PIN CONFIGURATION

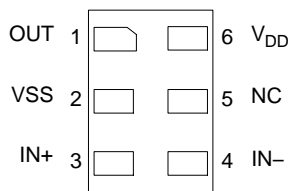

Figure 2. Pin Configuration (Top-Through View)

PIN DEFINITIONS

Pin #	Name	Description
1	OUT	Comparator Output
2	V_{SS}	Negative Supply Voltage
3	IN+	Non-Inverting Input
4	IN-	Inverting Input
5	NC	No Connect
6	V_{DD}	Positive Supply Voltage

FUNCTION TABLE

Inputs	Outputs
$IN(-) > IN(+)$	Output LOW
$IN(+ > IN(-)$	Output HIGH

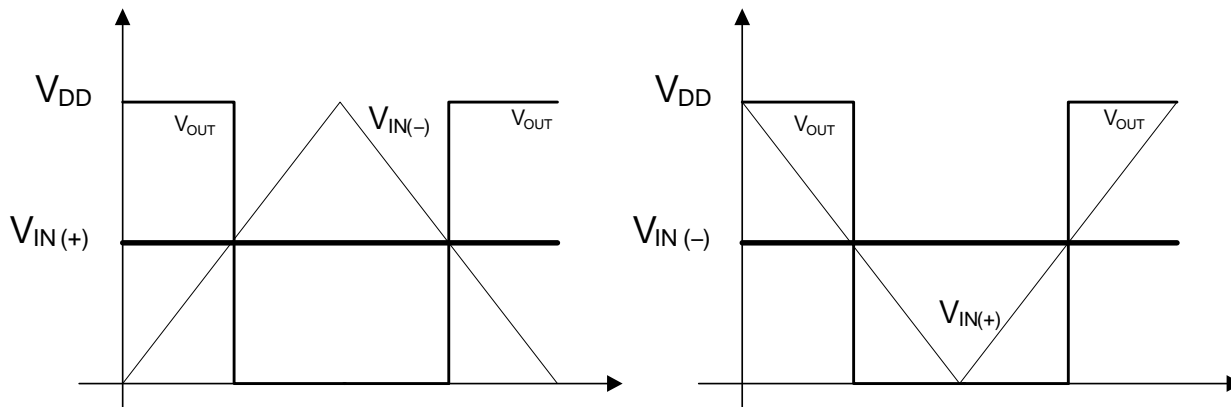

Figure 3. V_{IN} vs. V_{OUT}

FAN156

ABSOLUTE MAXIMUM RATINGS

Symbol	Parameter	Condition	Min.	Max.	Unit
V _{DD} to V _{SS}	Supply Voltage		-3.0	+3.0	V
			0	6.0	
DV _{IN}	Differential Input Voltage			±6	
V _{IN}	Input Voltage			V _{SS} to V _{DD}	V
t _s	Output Short Circuit Duration (Note 1)			Indefinite	s
T _J	Junction Temperature			+150	°C
T _{STG}	Storage Temperature Range		-65	+150	°C
P _D	Power Dissipation			194	mW
θ _{JA}	Thermal Resistance			335	°C/W
ESD	IEC 61000-4-2 System ESD	Air Gap		15	kV
		Contact		8	
	JEDEC JESD22-A114, Human Body Model	All Pins		8	
		Pin to Pin: IN(-), IN(+) to V _{DD} or V _{SS}		12	
	JEDEC JESD22-C101, Charged Device Model	All Pins		2	

Stresses exceeding those listed in the Maximum Ratings table may damage the device. If any of these limits are exceeded, device functionality should not be assumed, damage may occur and reliability may be affected.

1. The maximum total power dissipation must not be exceeded.

RECOMMENDED OPERATING CONDITIONS

Symbol	Parameter	Condition	Min.	Max.	Unit
V _{DD} to V _{SS}	Power Supply		-2.75	+2.75	V
			0	5.50	
V _{DD}	Power Supply	V _{SS} 0 V	1.6	5.5	V
V _{IN}	Input Voltage			V _{SS} to V _{DD}	V
I _{OH} /I _{OL}	Output Sink/Source Current	V _{DD} 5.0 V		5	mA
		V _{DD} 3.0 V		3	
		V _{DD} 1.6 V		1	
T _A	Operating Temperature, Free Air		-40	+85	°C

Functional operation above the stresses listed in the Recommended Operating Ranges is not implied. Extended exposure to stresses beyond the Recommended Operating Ranges limits may affect device reliability.

FAN156

ELECTRICAL CHARACTERISTICS

Symbol	Parameter	Condition	Min.	Typ.	Max.	Unit
V_{DD} = 5.5 V, V_{SS} = GND, and T_A = +25°C						
V _{HYS}	Input Hysteresis	V _{CM} = 0.5 V _{DD}		4		mV
V _{IO}	Input Offset Voltage (Note 2)	V _{CM} = 0.5 V _{DD}	-15	±1	+15	mV
I _{IO}	Input Offset Current			10		µA
I _I	Input Bias Current			10		µA
V _{CM}	Common Mode Input Voltage		V _{SS}		V _{DD}	V
CMRR	Common Mode Rejection Ratio (Note 3)	V _{CM} = V _{DD}		68		dB
I _{DD}	Supply Current			6	17	µA
PSRR	Power Supply Rejection Ratio (Note 3)	ΔV _{DD} = 0.5 V	45	80		dB
I _{OS}	Output Short Circuit Current	V _O = V _{DD}		60		mA
		V _O = V _{SS}		90		
V _{OL}	Low-Level Output Voltage	I _{SINK} = 5.0 mA		0.1	0.3	V
V _{OH}	High-Level Output Voltage	I _{SOURCE} = 5.0 mA	5.2	5.4		V
t _{PLH}	Propagation Delay (Turn-On)	Overdrive 20 mV, C _L = 15 pF		0.40		µs
t _{PHL}	Propagation Delay (Turn-Off)	Overdrive = 20 mV, C _L = 15 pF		0.42		µs
t _{TLH}	Response Time, Output Rise/Fall (Note 4)	C _L = 50 pF		4.0		ns
t _{THL}				5.4		

V_{DD} = 3 V, V_{SS} = GND, and T_A = +25°C

V _{HYS}	Input Hysteresis	V _{CM} = 0.5 V _{DD}		4		mV
V _{IO}	Input Offset Voltage (Note 2)	V _{CM} = 0.5 V _{DD}	-15	±1	+15	mV
I _{IO}	Input Offset Current			10		µA
I _I	Input Bias Current			10		µA
V _{CM}	Common Mode Input Voltage		V _{SS}		V _{DD}	V
CMRR	Common Mode Rejection Ratio (Note 3)	V _{CM} = V _{DD}		60		dB
I _{DD}	Supply Current			5.5	15.0	µA
PSRR	Power Supply Rejection Ratio (Note 3)	ΔV _{DD} = 0.5 V	45	80		dB
I _{OS}	Output Short Circuit Current	V _O = V _{DD}		27		mA
		V _O = V _{SS}		35		
V _{OL}	Low-Level Output Voltage	I _{SINK} = 3.0 mA		0.15	0.35	V
V _{OH}	High-Level Output Voltage	I _{SOURCE} = 3.0 mA	2.65	2.85		V
t _{PLH}	Propagation Delay (Turn-On)	Overdrive = 20 mV, C _L = 15 pF		0.45		µs
t _{PHL}	Propagation Delay (Turn-Off)	Overdrive = 20 mV, C _L = 15 pF		0.47		µs
t _{TLH}	Response Time, Output Rise/Fall (Note 4)	C _L = 50 pF		6.1		ns
t _{THL}				6.2		

V_{DD} = 1.6 V, V_{SS} = GND, and T_A = +25°C

V _{HYS}	Input Hysteresis	V _{CM} = 0.5 V _{DD}		3.5		mV
V _{IO}	Input Offset Voltage (Note 2)	V _{CM} = 0.5 V _{DD}	-15	±1	+15	mV
I _{IO}	Input Offset Current			10		µA
I _I	Input Bias Current			10		µA
V _{CM}	Common Mode Input Voltage		V _{SS}		V _{DD}	V
CMRR	Common Mode Rejection Ratio (Note 3)	V _{CM} = V _{DD}		56		dB

FAN156

ELECTRICAL CHARACTERISTICS (continued)

Symbol	Parameter	Condition	Min.	Typ.	Max.	Unit
$V_{DD} = 1.6\text{ V}$, $V_{SS} = \text{GND}$, and $T_A = +25^\circ\text{C}$						
I_{DD}	Supply Current			5	15	μA
PSRR	Power Supply Rejection Ratio (Note 3)	$\Delta V_{DD} = 0.5\text{ V}$	45	80		dB
I_{OS}	Output Short Circuit Current	$V_O = V_{DD}$		5.5		mA
		$V_O = V_{SS}$		7.5		
V_{OL}	Low-Level Output Voltage	$I_{SINK} = 5.0\text{ mA}$		0.10	0.25	V
V_{OH}	High-Level Output Voltage	$I_{SOURCE} = 5.0\text{ mA}$	1.35	1.50		V
t_{PLH}	Propagation Delay (Turn-On)	Overdrive 20 mV, $C_L = 15\text{ pF}$		0.52		μs
t_{PHL}	Propagation Delay (Turn-Off)	Overdrive = 20 mV, $C_L = 15\text{ pF}$		0.54		μs
t_{TLH}	Response Time, Output Rise/Fall (Note 4)	$C_L = 50\text{ pF}$		16.5		ns
t_{THL}				13.0		

2. Differential input switching level is guaranteed at the minimum or maximum offset voltage, minus or plus half the maximum hysteresis voltage.

3. Guaranteed by design and characterization data.

4. Input signal: 1 kHz, square-wave signal with 10 ns edge rate.

TYPICAL PERFORMANCE CHARACTERISTICS

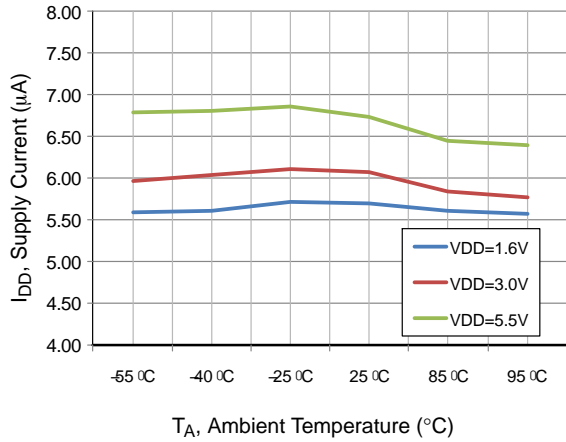

Figure 4. Supply Current vs. Temperature

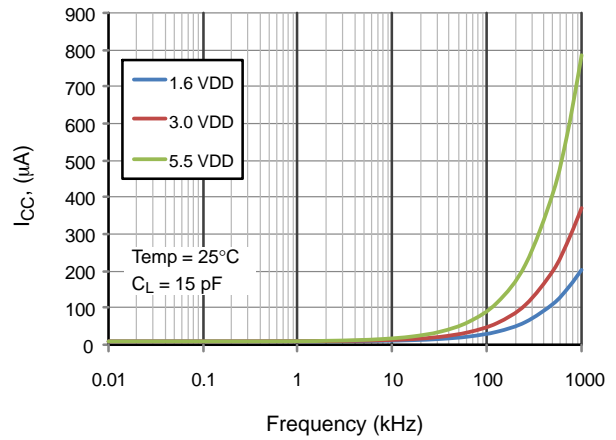

Figure 5. Supply Current vs. Output Transition Frequency

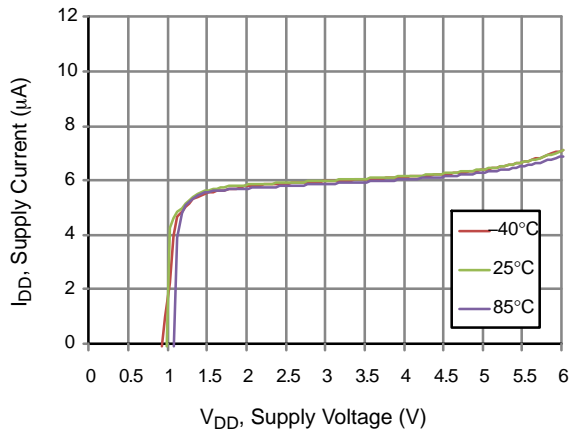

Figure 6. Supply Current vs. Supply Voltage

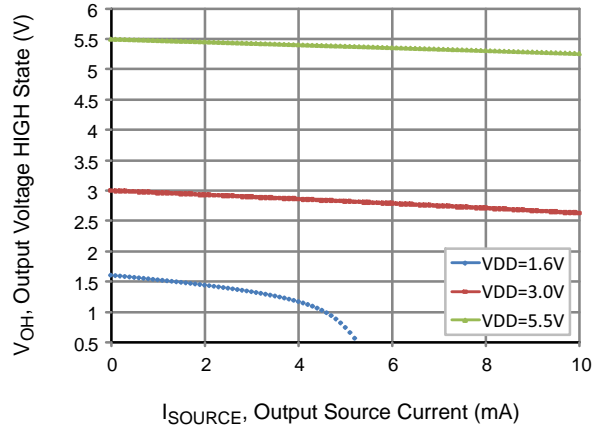

Figure 7. Output HIGH vs. Output Drive Current

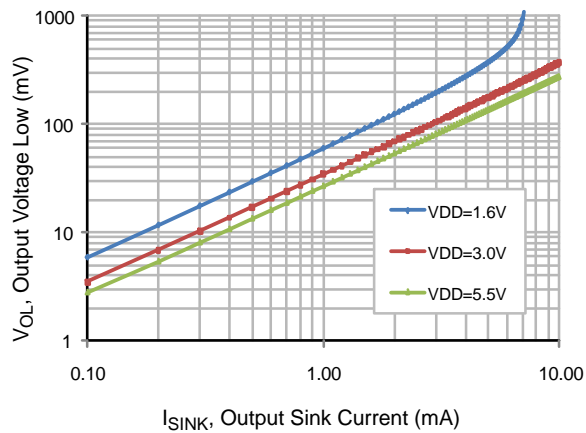

Figure 8. Output LOW vs. Output Drive Current

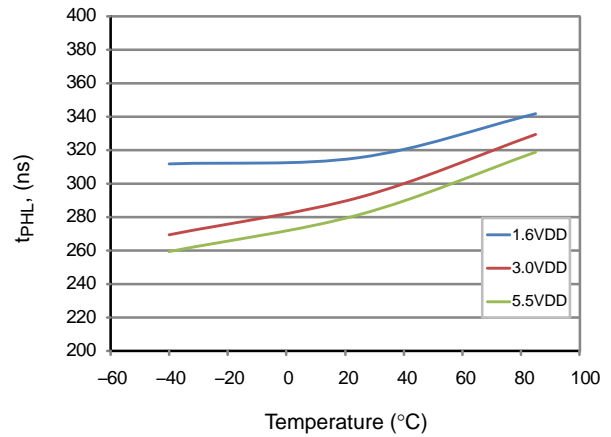

Figure 9. Propagation Delay t_{PHL} vs. Temperature

FAN156

TYPICAL PERFORMANCE CHARACTERISTICS (continued)

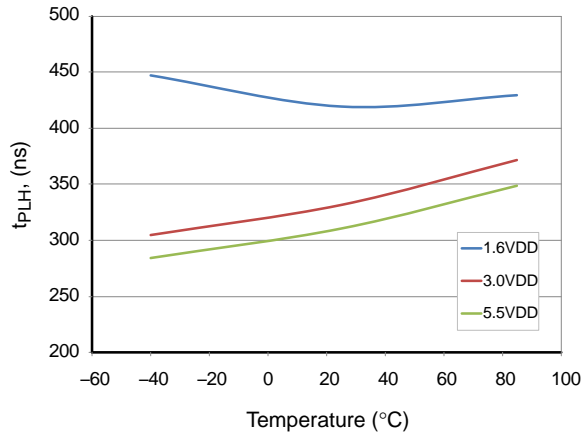

Figure 10. Propagation Delay $t_{(PLH)}$ vs. Temperature

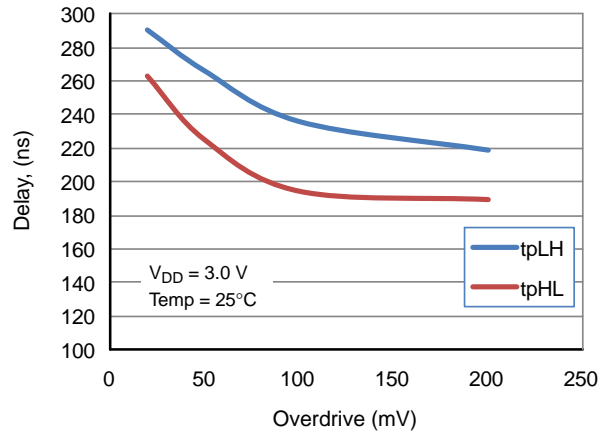

Figure 11. Propagation Delay vs. Input Overdrive

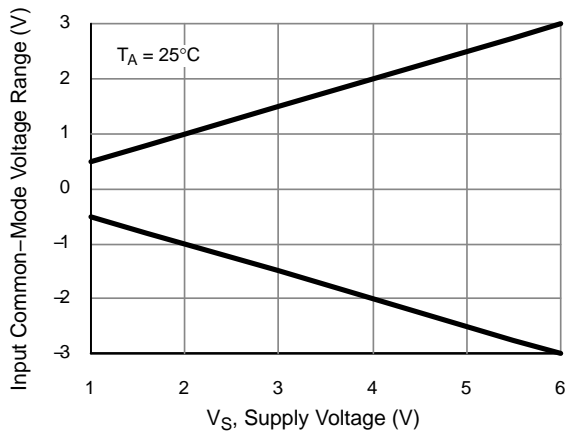

Figure 12. Input Common-Mode Voltage Range vs. Supply Voltage

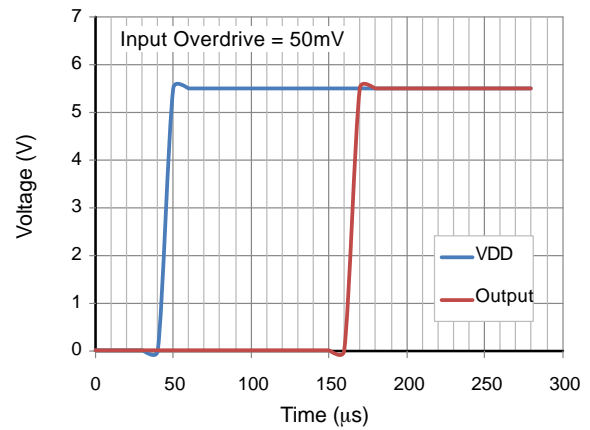

Figure 13. Power-Up Delay

ORDERING INFORMATION

Device	Operating Temperature Range	Top Mark	Package	Shipping†
FAN156L6X	-40°C to +85°C	CN	6-Lead, SIP6 1.45x1.0 (MicroPak™) (Pb-Free)	5000 / Tape & Reel

†For information on tape and reel specifications, including part orientation and tape sizes, please refer to our Tape and Reel Packaging Specifications Brochure, BRD8011/D.

MicroPak is a trademark of Semiconductor Components Industries, LLC dba "onsemi" or its affiliates and/or subsidiaries in the United States and/or other countries.

MECHANICAL CASE OUTLINE

PACKAGE DIMENSIONS

ON Semiconductor®



SIP6 1.45X1.0
CASE 127EB
ISSUE O

DATE 31 AUG 2016

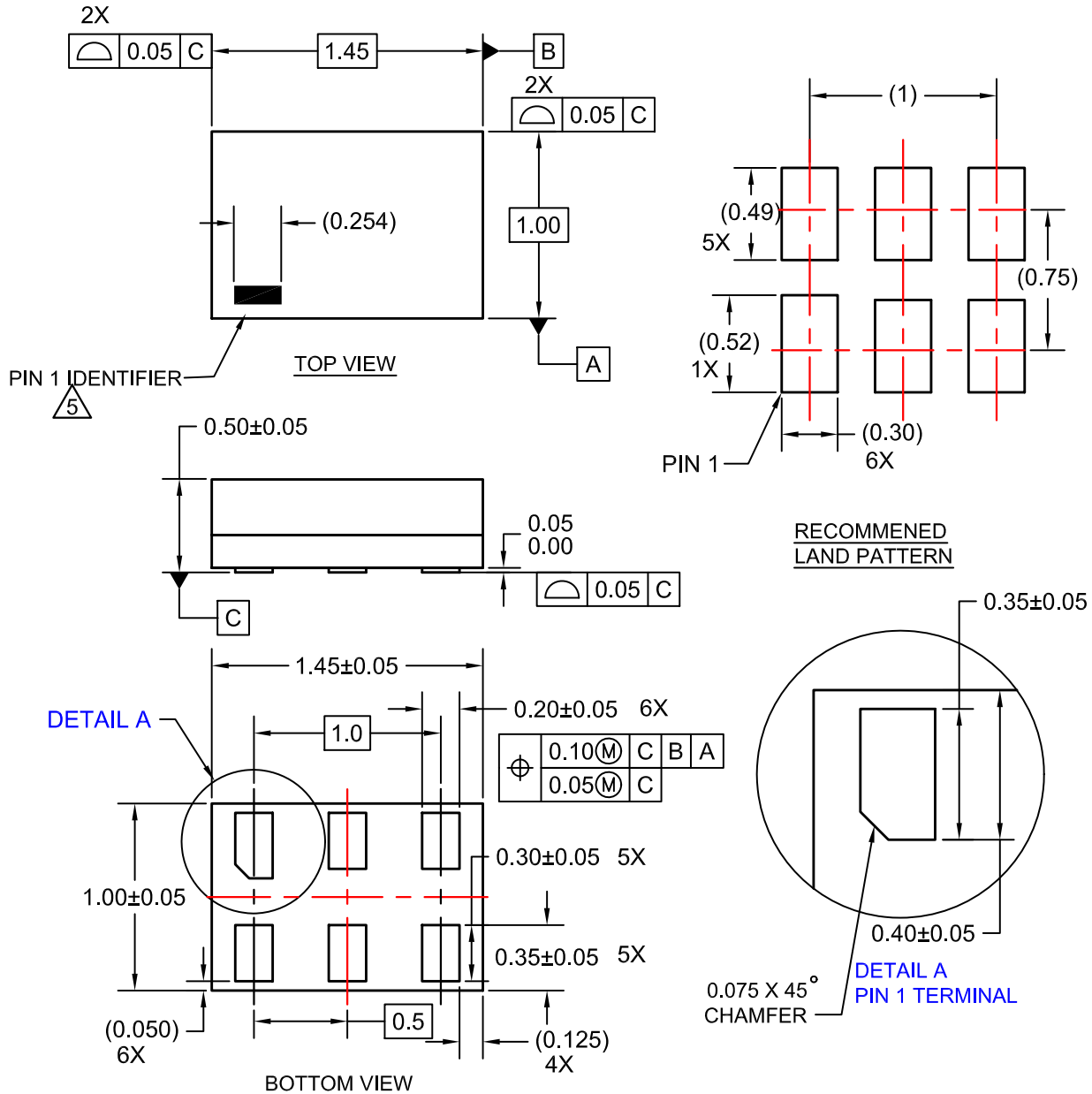

NOTES:

1. CONFORMS TO JEDEC STANDARD MO-252 VARIATION UAAD
2. DIMENSIONS ARE IN MILLIMETERS
3. DRAWING CONFORMS TO ASME Y14.5M-2009
4. PIN ONE IDENTIFIER IS 2X LENGTH OF ANY OTHER LINE IN THE MARK CODE LAYOUT.

DOCUMENT NUMBER:	98AON13590G	Electronic versions are uncontrolled except when accessed directly from the Document Repository. Printed versions are uncontrolled except when stamped "CONTROLLED COPY" in red.
DESCRIPTION:	SIP6 1.45X1.0	PAGE 1 OF 1

ON Semiconductor and are trademarks of Semiconductor Components Industries, LLC dba ON Semiconductor or its subsidiaries in the United States and/or other countries. ON Semiconductor reserves the right to make changes without further notice to any products herein. ON Semiconductor makes no warranty, representation or guarantee regarding the suitability of its products for any particular purpose, nor does ON Semiconductor assume any liability arising out of the application or use of any product or circuit, and specifically disclaims any and all liability, including without limitation special, consequential or incidental damages. ON Semiconductor does not convey any license under its patent rights nor the rights of others.

onsemi, **Onsemi**, and other names, marks, and brands are registered and/or common law trademarks of Semiconductor Components Industries, LLC dba "**onsemi**" or its affiliates and/or subsidiaries in the United States and/or other countries. **onsemi** owns the rights to a number of patents, trademarks, copyrights, trade secrets, and other intellectual property. A listing of **onsemi**'s product/patent coverage may be accessed at www.onsemi.com/site/pdf/Patent-Marking.pdf. **onsemi** reserves the right to make changes at any time to any products or information herein, without notice. The information herein is provided "as-is" and **onsemi** makes no warranty, representation or guarantee regarding the accuracy of the information, product features, availability, functionality, or suitability of its products for any particular purpose, nor does **onsemi** assume any liability arising out of the application or use of any product or circuit, and specifically disclaims any and all liability, including without limitation special, consequential or incidental damages. Buyer is responsible for its products and applications using **onsemi** products, including compliance with all laws, regulations and safety requirements or standards, regardless of any support or applications information provided by **onsemi**. "Typical" parameters which may be provided in **onsemi** data sheets and/or specifications can and do vary in different applications and actual performance may vary over time. All operating parameters, including "Typicals" must be validated for each customer application by customer's technical experts. **onsemi** does not convey any license under any of its intellectual property rights nor the rights of others. **onsemi** products are not designed, intended, or authorized for use as a critical component in life support systems or any FDA Class 3 medical devices or medical devices with a same or similar classification in a foreign jurisdiction or any devices intended for implantation in the human body. Should Buyer purchase or use **onsemi** products for any such unintended or unauthorized application, Buyer shall indemnify and hold **onsemi** and its officers, employees, subsidiaries, affiliates, and distributors harmless against all claims, costs, damages, and expenses, and reasonable attorney fees arising out of, directly or indirectly, any claim of personal injury or death associated with such unintended or unauthorized use, even if such claim alleges that **onsemi** was negligent regarding the design or manufacture of the part. **onsemi** is an Equal Opportunity/Affirmative Action Employer. This literature is subject to all applicable copyright laws and is not for resale in any manner.

PUBLICATION ORDERING INFORMATION

LITERATURE FULFILLMENT:

Email Requests to: orderlit@onsemi.com

onsemi Website: www.onsemi.com

TECHNICAL SUPPORT

North American Technical Support:

Voice Mail: 1 800-282-9855 Toll Free USA/Canada

Phone: 011 421 33 790 2910

Europe, Middle East and Africa Technical Support:

Phone: 00421 33 790 2910

For additional information, please contact your local Sales Representative