

DF37 Series

0.4mm Pitch, 0.98/1.5mm Stacking Height, FPC-to-Board Connectors

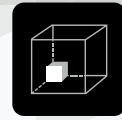

Space Saving



Contact Reliability



Wide Variation

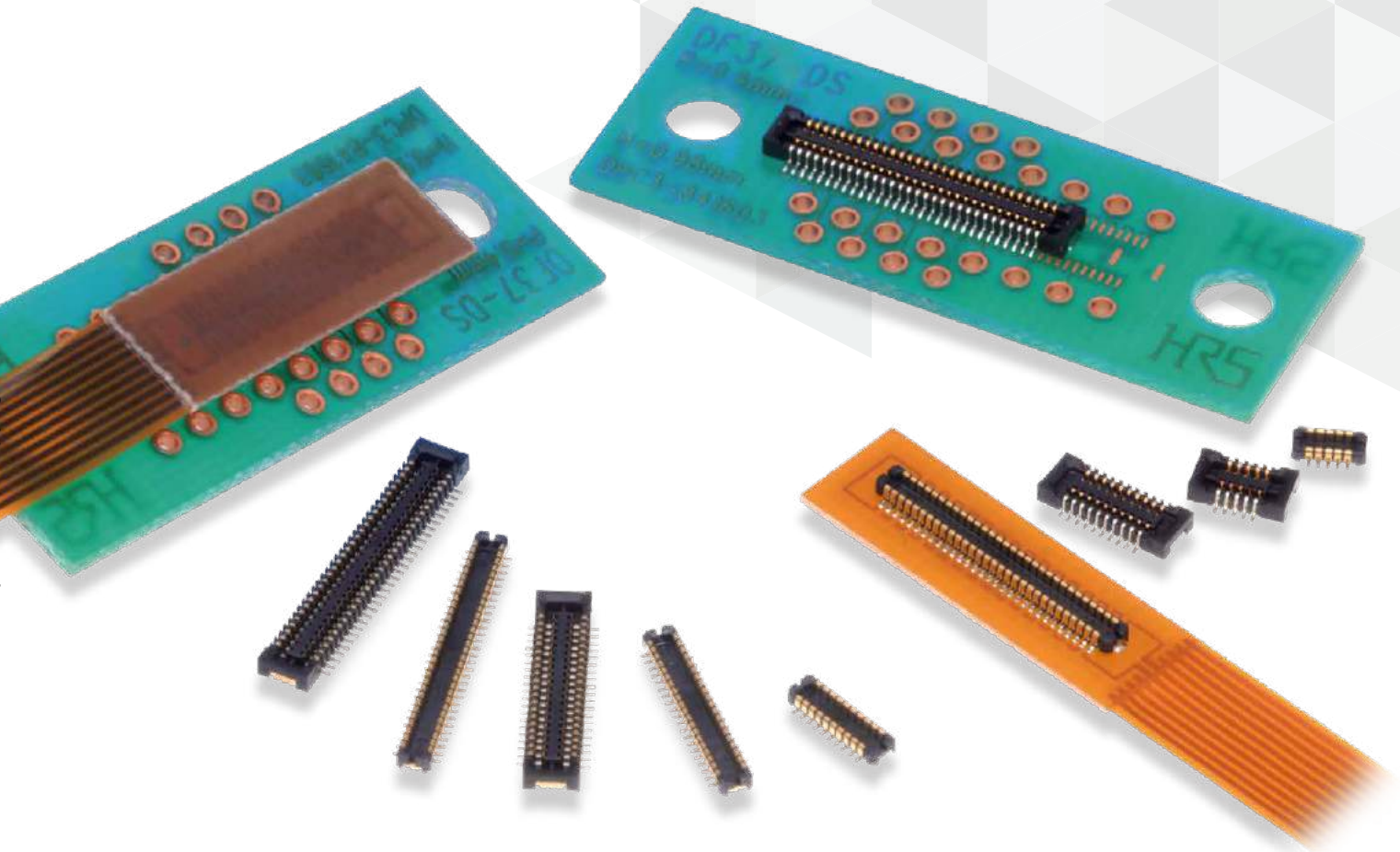

Features

1. Contributes to End Product Size Reduction

Space-saving design with minimal connector depth and an automatic placement area that does not interfere with mounting (tested).

Depth: When mated 2.98mm

Header 1.98mm

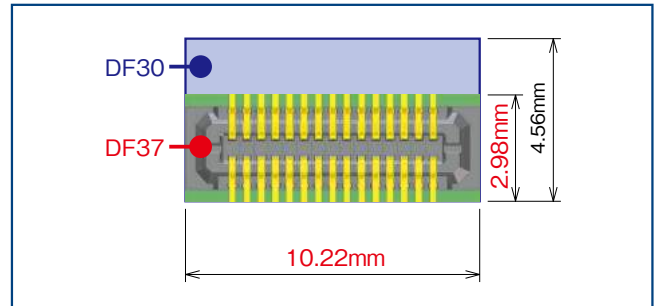

PCB Mounting Space Comparison(40pos., 0.4mm Pitch, 0.98mm Height)

2. High Contact Reliability

DF37 has an effective mating length of 0.25mm, one of the longest for connectors with a 1.0mm mated height. The clear tactile click prevents incomplete mating and the 2-point contact design provides a high mating force.

3. Wide Mating Self-Alignment Range

The guide ribs effectively utilize dead space, enabling a self alignment range of 0.3mm.

4. Robust Design with Shock Absorbing Contacts

Locks on both sides of the 2-point contact absorb stress on impact.

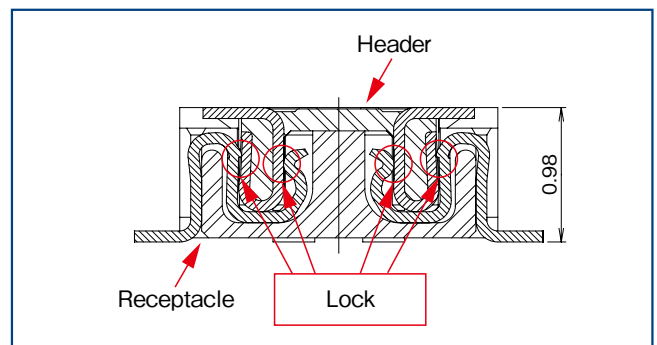

5. Solder Wicking Prevention

The receptacle with nickel barrier and the insert molder header prevent solder wicking.

6. Contamination Protection

Insulator walls protect the contact areas against flux splatter or other physical particle contamination.

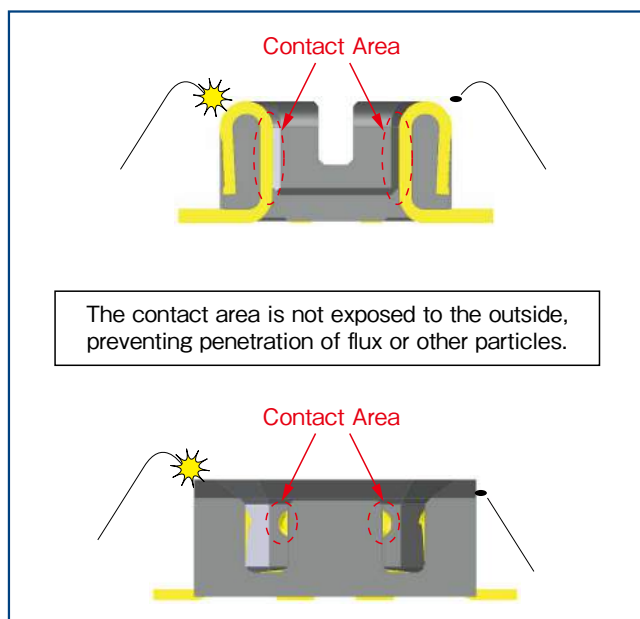

Product Specifications

Rated Current	0.3A	Operating Temperature (Note 1)	-35 to +85°C
Rated Voltage	30V AC/DC	Storage Temperature (Note 2)	-10 to +60°C
		Operating Humidity Range	20-80%
		Storage Humidity Range (Note 2)	40-70%

Item	Specification	Conditions
Insulation Resistance	50M Ω Min.	100V DC
Withstanding Voltage	No flashover or insulation breakdown	100V AC / 1minute
Contact Resistance	100m Ω Max.	20mV AC, 1kHz, 1mA
Vibration	No electrical discontinuity of 1 μ s or longer	Frequency : 10 to 55 Hz, single amplitude of 0.75mm, 2 hours, 3 axis
Humidity	Contact resistance : 100m Ω Max., Insulation resistance : 25M Ω Min.	96 hours at 40 \pm 2°C and humidity of 90 to 95% No damage or parts dislocation
Temperature Cycle	Contact resistance : 100m Ω Max., Insulation resistance : 50M Ω Min.	-55°C \rightarrow +5 to +35°C \rightarrow +85°C \rightarrow +5 to +35°C Time: 30 min. \rightarrow 10 min. \rightarrow 30 min. \rightarrow 10 min. 5 cycles
Mating Durability	Contact resistance : 100m Ω Max.	10 cycles
Solder Heat Resistance	No deformation of components affecting performance	Reflow : At the recommended temperature profile Hand solder : Solder iron temperature of 350°C for 3 seconds Max.

Note 1 : Includes temperature rise caused by current flow.

Note 2 : Storage refers to long-term storage of unused items before they are mounted on the PCB.

Operating temperature and humidity range apply when the product is not powered after PCB mounting and when temporarily stored during transportation.

Materials / Finish

Product	Part	Material	Finish	Remarks
Receptacle Header	Insulator	LCP	Color: Black	UL94V-0
	Contacts	Phosphor Bronze	Gold Plated	-

Product Number Structure

Refer to the chart below when determining the product specifications from the product number.
Please select from the product numbers listed in this catalog when placing orders.

■ Receptacle

DF37 # (##) - # DS - 0.4 V (##)

① ② ③ ④ ⑤ ⑥ ⑦ ⑧

① Series Name	DF37	④ No. of Pos.	
② Configuration	NB : With Retention Tabs NC : Without Retention Tabs	⑤ Connector Type	DS : Receptacle
		⑥ Contact Pitch	0.4mm
		⑦ Termination Type	V : SMT Vertical Mount
③ Stacking Height	Blank : 0.98mm 1.5 : 1.5mm	⑧ Packaging	(51) Stacking Height 0.98mm : Embossed Tape Packaging (8,000pcs per reel)
			(51) Stacking Height 1.5mm : Embossed Tape Packaging (5,000pcs per reel)
			(53) : Embossed Tape Packaging (1,000pcs per reel)

■ Header

DF37 # - # DP - 0.4 V (##)

① ② ③ ④ ⑤ ⑥ ⑦

① Series Name	DF37	⑤ Contact Pitch	0.4mm
② Configuration	B : With Retention Tabs C : Without Retention Tabs	⑥ Termination Type	V : SMT Vertical Mount
		⑦ Packaging	(51) : Embossed Tape Packaging (8,000pcs per reel)
③ No. of Pos.			
④ Connector Type	DP : Double Row Header		

Receptacle (Stacking Height=0.98mm)

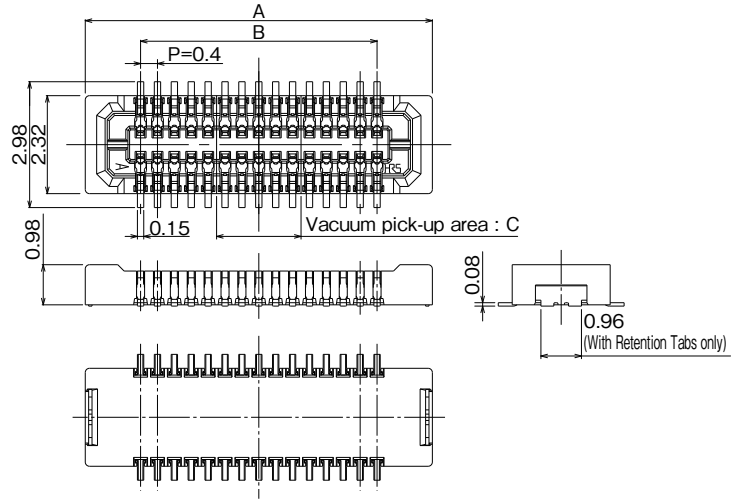
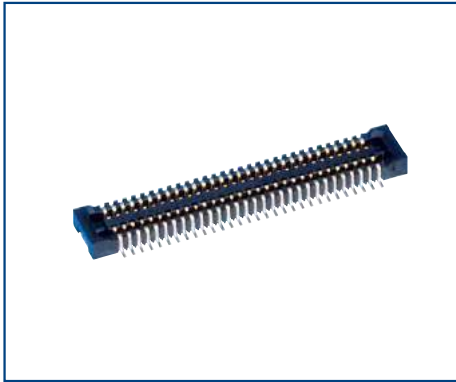

Recommended PCB Layout

DF37NB
With Retention Tabs

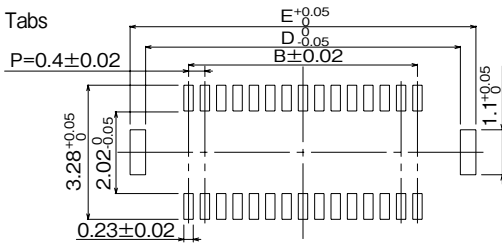

DF37NC
Without Retention Tabs

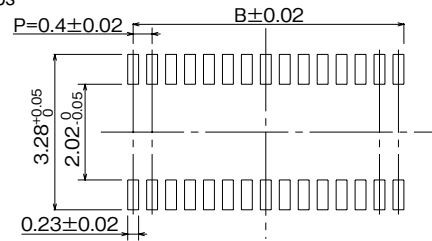

Recommended Metal Mask Dimensions

DF37NB
With Retention Tabs

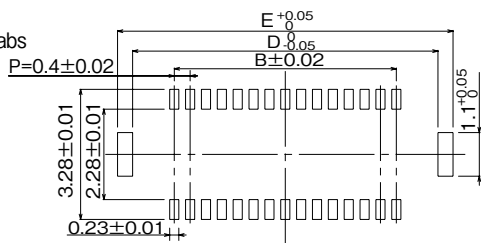

DF37NC
Without Retention Tabs

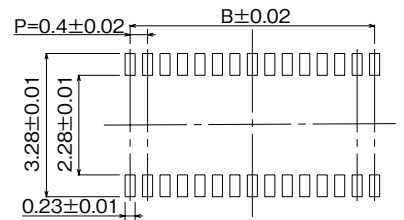

● With Retention Tabs

Unit : mm

Part No.	HRS No.	No. of Pos.	A	B	C	D	E	Purchase Unit (##) : (51)	Purchase Unit (##) : (53)
DF37NB-10DS-0.4V(##)	CL0684-3301-6-##	10	4.22	1.6	0.8	3.7	4.46	8,000pcs per reel	1,000pcs per reel
DF37NB-16DS-0.4V(##)	CL0684-3302-9-##	16	5.42	2.8	1.2	4.9	5.66		
DF37NB-20DS-0.4V(##)	CL0684-3303-1-##	20	6.22	3.6	1.6	5.7	6.46		
DF37NB-24DS-0.4V(##)	CL0684-3304-4-##	24	7.02	4.4	2	6.5	7.26		
DF37NB-30DS-0.4V(##)	CL0684-3305-7-##	30	8.22	5.6		7.7	8.46		
DF37NB-34DS-0.4V(##)	CL0684-3082-4-##	34	9.02	6.4	2.4	8.5	9.26		
DF37NB-40DS-0.4V(##)	CL0684-3306-0-##	40	10.22	7.6		9.7	10.46		
DF37NB-44DS-0.4V(##)	CL0684-3407-7-##	44	11.02	8.4	2.8	10.5	11.26		
DF37NB-50DS-0.4V(##)	CL0684-3307-2-##	50	12.22	9.6		11.7	12.46		
DF37NB-60DS-0.4V(##)	CL0684-3308-5-##	60	14.22	11.6	3.2	13.7	14.46		
DF37NB-70DS-0.4V(##)	CL0684-3409-2-##	70	16.22	13.6	3.6	15.7	16.46		

● Without Retention Tabs

Unit : mm

Part No.	HRS No.	No. of Pos.	A	B	C	Purchase Unit (##) : (51)	Purchase Unit (##) : (53)
DF37NC-10DS-0.4V(##)	CL0684-3309-8-##	10	4.22	1.6	0.8	8,000pcs per reel	1,000pcs. per reel
DF37NC-16DS-0.4V(##)	CL0684-3310-7-##	16	5.42	2.8	1.2		
DF37NC-20DS-0.4V(##)	CL0684-3311-0-##	20	6.22	3.6	1.6		
DF37NC-24DS-0.4V(##)	CL0684-3312-2-##	24	7.02	4.4	2		
DF37NC-30DS-0.4V(##)	CL0684-3313-5-##	30	8.22	5.6			
DF37NC-34DS-0.4V(##)	CL0684-3083-7-##	34	9.02	6.4	2.4		
DF37NC-40DS-0.4V(##)	CL0684-3314-8-##	40	10.22	7.6			
DF37NC-44DS-0.4V(##)	CL0684-3324-1-##	44	11.02	8.4	2.8		
DF37NC-50DS-0.4V(##)	CL0684-3315-0-##	50	12.22	9.6			
DF37NC-60DS-0.4V(##)	CL0684-3316-3-##	60	14.22	11.6	3.2		
DF37NC-70DS-0.4V(##)	CL0684-3084-0-##	70	16.22	13.6	3.6		

Note 1 : The position of the HRS and CAV marks may differ from the diagram.

Note 2 : This connector is NOT polarized.

Receptacle (Stacking Height=1.5mm)

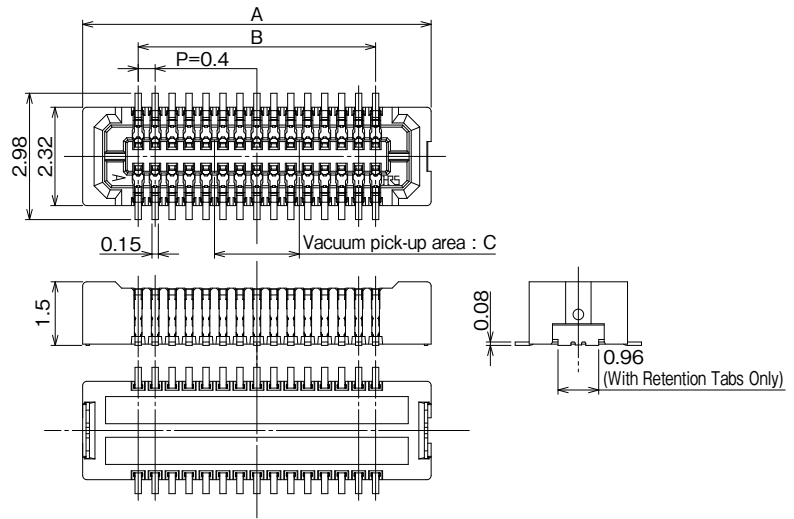

Recommended PCB Layout

DF37NB
With Retention Tabs

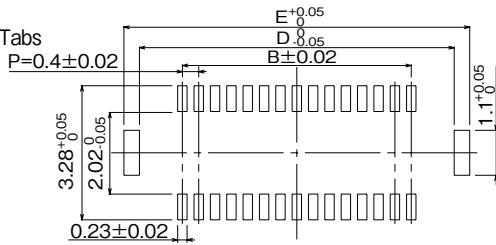

DF37NC
Without Retention Tabs

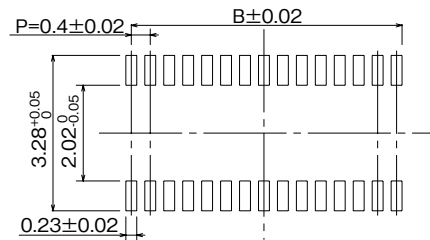

Recommended Metal Mask Dimensions

DF37NB
With Retention Tabs

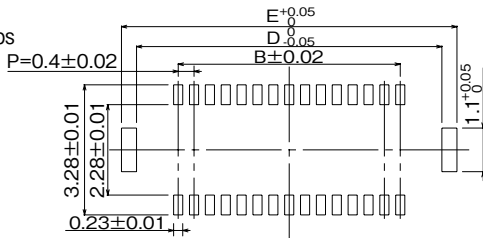

DF37NC
Without Retention Tabs

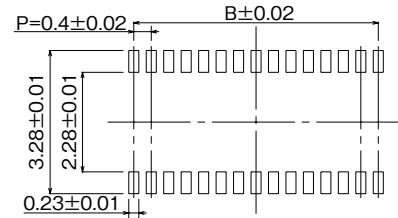

● With Retention Tabs

Unit : mm

Part No.	HRS No.	No. of Pos.	A	B	C	D	E	Purchase Unit (##) : (51)	Purchase Unit (##) : (53)
DF37NB(1.5)-24DS-0.4V(##)	CL0684-3602-2-##	24	7.02	4.4	2	6.5	7.26	5,000pcs per reel	1,000pcs per reel

● Without Retention Tabs

Unit : mm

Part No.	HRS No.	No. of Pos.	A	B	C	Purchase Unit (##) : (51)	Purchase Unit (##) : (53)
DF37NC(1.5)-24DS-0.4V(##)	CL0684-3603-5-##	24	7.02	4.4	2	5,000pcs per reel	1,000pcs per reel
DF37NC(1.5)-30DS-0.4V(##)	CL0684-3604-8-##	30	8.22	5.6			
DF37NC(1.5)-34DS-0.4V(##)	CL0684-3618-0-##	34	9.02	6.4	2.4		
DF37NC(1.5)-40DS-0.4V(##)	CL0684-3606-3-##	40	10.22	7.6			
DF37NC(1.5)-50DS-0.4V(##)	CL0684-3610-0-##	50	12.22	9.6	2.8		
DF37NC(1.5)-60DS-0.4V(##)	CL0684-3613-9-##	60	14.22	11.6	3.2		
DF37NC(1.5)-70DS-0.4V(##)	CL0684-3614-1-##	70	16.22	13.6	3.6		

Note 1 : The position of the HRS and CAV marks may differ from the diagram.

Note 2 : This connector is NOT polarized.

Header

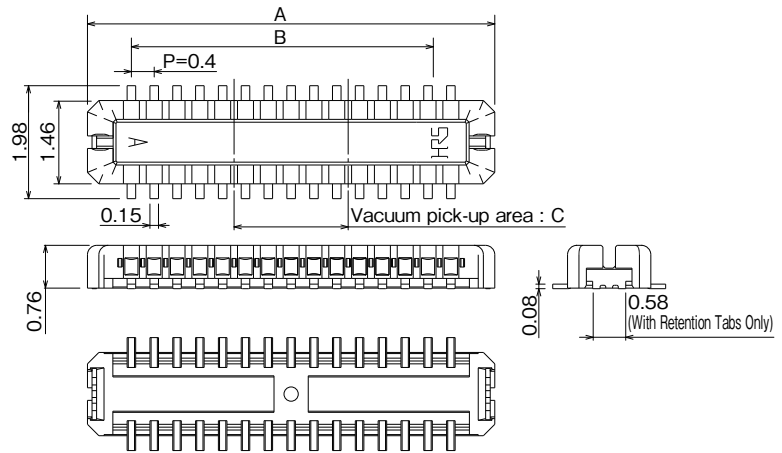

Recommended PCB Layout

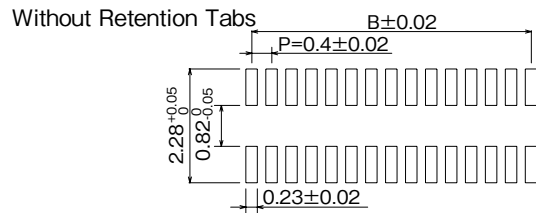
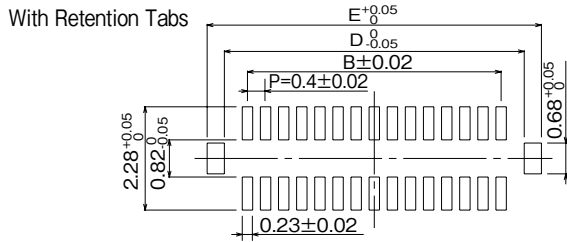

Recommended Metal Mask Dimensions

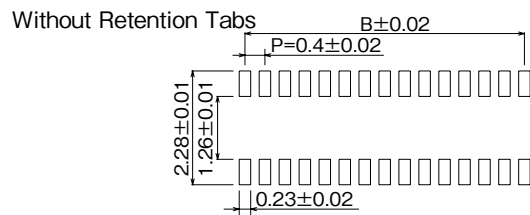
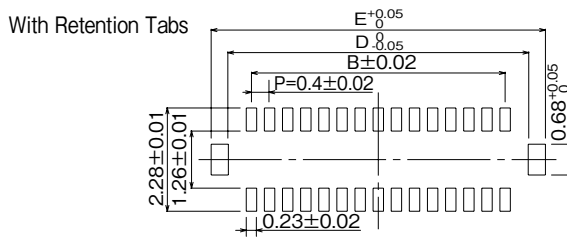

● With Retention Tabs

Unit : mm

Part No.	HRS No.	No. of Pos.	A	B	C	D	E	Purchase Unit (##) : (51)	Purchase Unit (##) : (53)
DF37B-10DP-0.4V(##)	CL0684-3037-0-##	10	3.14	1.6	0.8	2.62	3.38	8,000pcs per reel	1,000pcs per reel
DF37B-16DP-0.4V(##)	CL0684-3057-7-##	16	4.34	2.8	1.2	3.82	4.58		
DF37B-20DP-0.4V(##)	CL0684-3008-1-##	20	5.17	3.6	1.6	4.62	5.38		
DF37B-24DP-0.4V(##)	CL0684-3009-4-##	24	5.94	4.4	2	5.42	6.18		
DF37B-30DP-0.4V(##)	CL0684-3010-3-##	30	7.14	5.6		6.62	7.38		
DF37B-34DP-0.4V(##)	CL0684-3064-2-##	34	7.94	6.4	2.4	7.42	8.18		
DF37B-40DP-0.4V(##)	CL0684-3011-6-##	40	9.14	7.6		8.62	9.38		
DF37B-44DP-0.4V(##)	CL0684-3408-0-##	44	9.94	8.4	2.8	9.42	10.18		
DF37B-50DP-0.4V(##)	CL0684-3012-9-##	50	11.14	9.6		10.62	11.38		
DF37B-60DP-0.4V(##)	CL0684-3013-1-##	60	13.14	11.6		3.2	12.62		
DF37B-70DP-0.4V(##)	CL0684-3014-4-##	70	15.14	13.6	3.6	14.62	15.38		

● Without Retention Tabs

Unit : mm

Part No.	HRS No.	No. of Pos.	A	B	C	Purchase Unit (##) : (51)	Purchase Unit (##) : (53)
DF37C-10DP-0.4V(##)	CL0684-3039-5-##	10	3.14	1.6	0.8	8,000pcs per reel	1,000pcs per reel
DF37C-16DP-0.4V(##)	CL0684-3058-0-##	16	4.34	2.8	1.2		
DF37C-20DP-0.4V(##)	CL0684-3024-8-##	20	5.17	3.6	1.6		
DF37C-24DP-0.4V(##)	CL0684-3025-0-##	24	5.94	4.4	2		
DF37C-30DP-0.4V(##)	CL0684-3026-3-##	30	7.14	5.6			
DF37C-34DP-0.4V(##)	CL0684-3085-2-##	34	7.94	6.4	2.4		
DF37C-40DP-0.4V(##)	CL0684-3027-6-##	40	9.14	7.6			
DF37C-44DP-0.4V(##)	CL0684-3089-3-##	44	9.94	8.4	2.8		
DF37C-50DP-0.4V(##)	CL0684-3028-9-##	50	11.14	9.6			
DF37C-60DP-0.4V(##)	CL0684-3029-1-##	60	13.14	11.6	3.2		
DF37C-70DP-0.4V(##)	CL0684-3030-0-##	70	15.14	13.6	3.6		

Note 1 : The position of the HRS and CAV marks may differ from the diagram.

Note 2 : This connector is NOT polarized.

Embossed Carrier Tape Dimensions (JIS C 0806 Standard)

● Receptacle (Less Than 70 Positions)

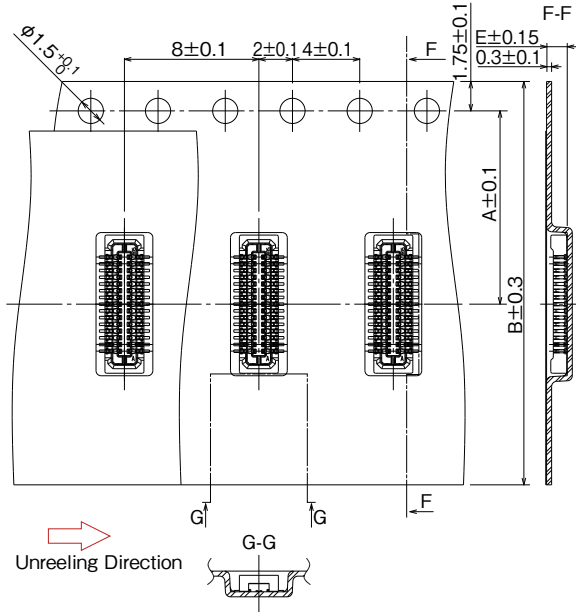

● Receptacle (70 Positions)

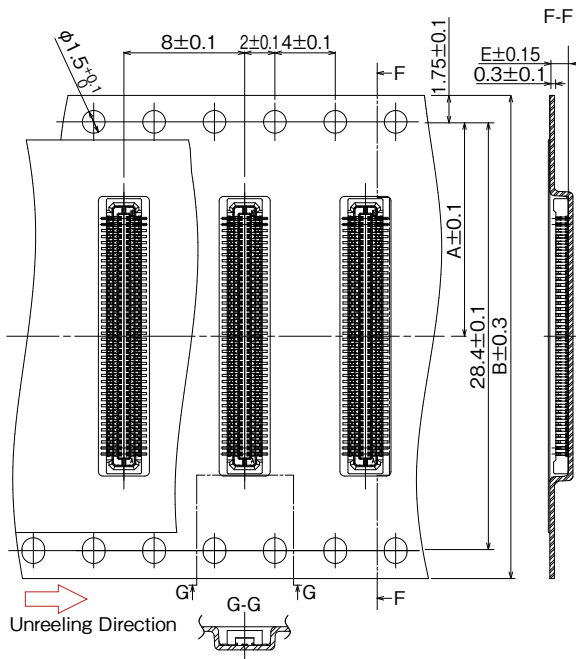

● Reel Dimensions

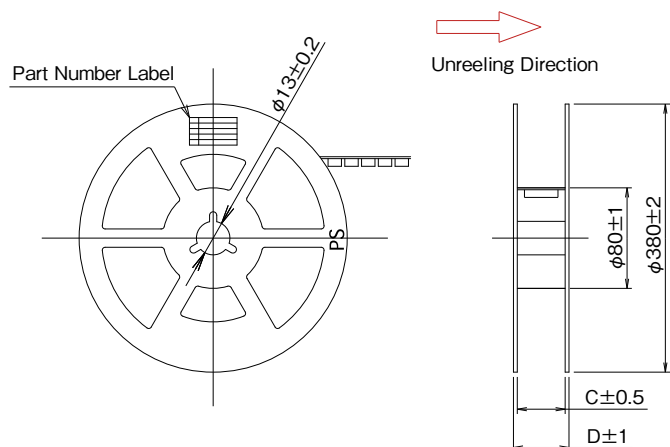

Unit : mm

Part No.	A	B	C	D	E
DF37#-10DS-0.4V(##)	7.5	16	17.5	21.5	1.23
DF37#-16DS-0.4V(##)					
DF37#-20DS-0.4V(##)					
DF37#-24DS-0.4V(##)					
DF37#-30DS-0.4V(##)	11.5	24	25.5	29.5	
DF37#-34DS-0.4V(##)					
DF37#-40DS-0.4V(##)					
DF37#-44DS-0.4V(##)					
DF37#-50DS-0.4V(##)					
DF37#-60DS-0.4V(##)					
DF37#-70DS-0.4V(##)	14.2	32	33.5	37.5	

: NB or NC

Tape and reel packaging (8,000pcs per reel).

Unit : mm

Part No.	A	B	C	D	E
DF37#(1.5)-24DS-0.4V(##)	7.5	16	17.5	21.5	1.75
DF37#(1.5)-30DS-0.4V(##)					
DF37#(1.5)-34DS-0.4V(##)	11.5	24	25.5	29.5	
DF37#(1.5)-40DS-0.4V(##)					
DF37#(1.5)-50DS-0.4V(##)					
DF37#(1.5)-60DS-0.4V(##)					
DF37#(1.5)-70DS-0.4V(##)	14.2	32	33.5	37.5	

: NB or NC

Tape and reel packaging (5,000pcs per reel).

● Header

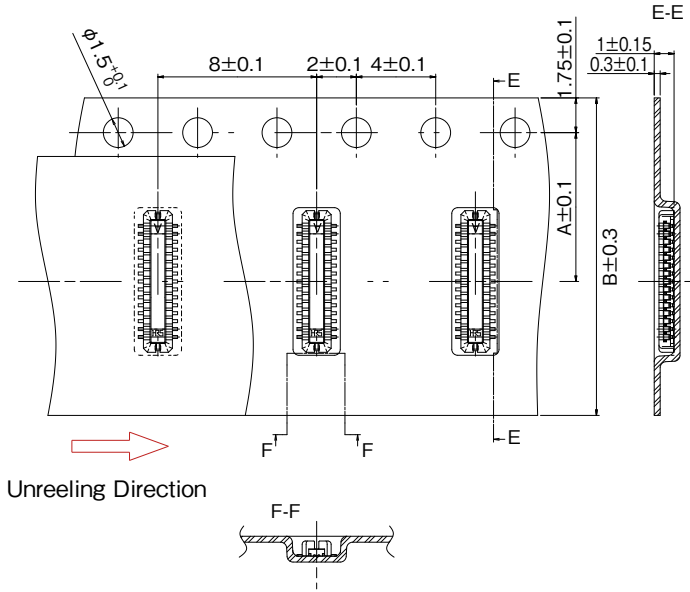

● Reel Dimensions

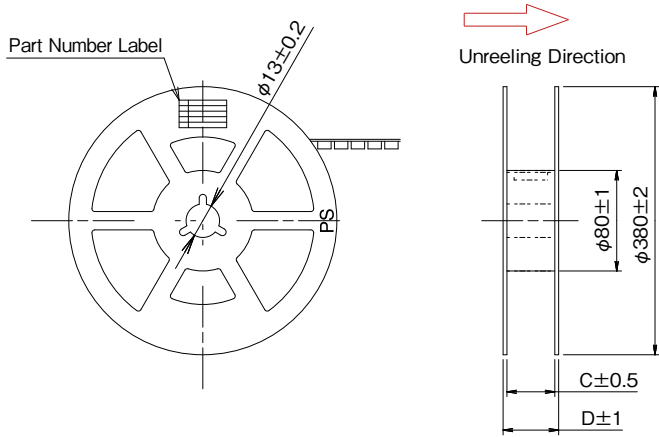

Unit : mm

Part No.	A	B	C	D
DF37#-10DP-0.4V(##)	5.5	12	13.5	17.5
DF37#-16DP-0.4V(##)	7.5	16	17.5	21.5
DF37#-20DP-0.4V(##)				
DF37#-24DP-0.4V(##)				
DF37#-30DP-0.4V(##)	11.5	24	25.5	29.5
DF37#-34DP-0.4V(##)				
DF37#-40DP-0.4V(##)				
DF37#-44DP-0.4V(##)				
DF37#-50DP-0.4V(##)				
DF37#-60DP-0.4V(##)				
DF37#-70DP-0.4V(##)				

: B, C
Tape and reel packaging (8,000pcs per reel).

Usage Precautions

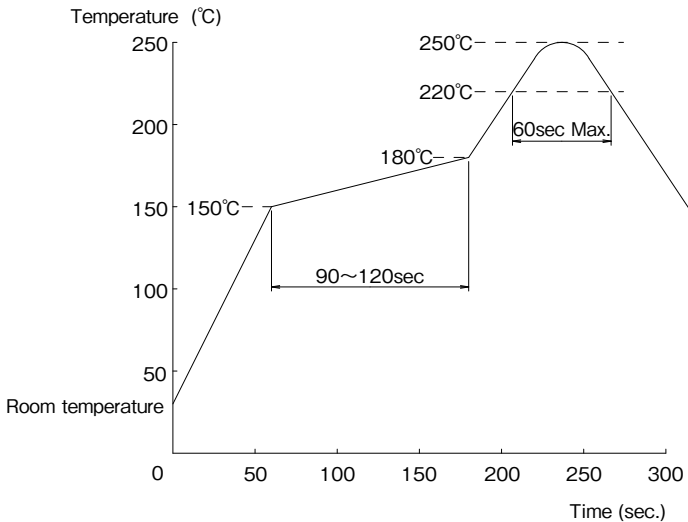
<p>1. Recommended Temperature Profile</p>	 <p>Temperature (°C)</p> <p>250 200 150 100 50 Room temperature</p> <p>0 50 100 150 200 250 300</p> <p>Time (sec.)</p> <p>150°C 180°C 220°C 250°C 60sec Max.</p> <p>90~120sec</p> <p>【Conditions】</p> <ol style="list-style-type: none"> 1. Peak Temperature: Maximum of 250°C 2. Heating : 220°C min. for 60 sec. max. 3. Preheating : 150 to 180°C , 90 to 120 sec. 4. Number of Reflow Cycles : 2 cycles max. <p>Note : The temperature refers to the surface temperature of the board near the connector lead.</p>
<p>2. Recommended Manual Soldering Conditions</p>	<p>Soldering Iron Temperature : 340 ± 10°C ; Soldering Time : within 3 seconds</p>
<p>3. Recommended Metal Mask Thickness and Open Area to PCB Pattern Area Ratio</p>	<p>Thickness : 0.12mm Open area ratio : Receptacle Side : 80%(NB/NC), Plug Side : 70%</p>
<p>4. Board Warpage</p>	<p>Max. of 0.02mm at the center in reference to both ends of the connector</p>
<p>5. Cleaning</p>	<p>Cleaning is not recommended. If you clean this product, please evaluate its performance before using it. (Cleaning may impair the mating/unmating properties and lower resistance to environmental factors)</p>
<p>6. Precautions</p>	<ul style="list-style-type: none"> ■ Be careful when mating/unmating the connector when it is not mounted on the PCB as it may cause damage/deformation to contacts. ■ Avoid supporting the PCB only with the connectors. Support it by other means such as bolts, screws, posts, etc. ■ Excessive prying during unmating/mating may result in damage.. ■ In the case of hand soldering, please do not apply any flux which could cause flux wicking. ■ This product may have slight color differences due to production lot variability, but this does not affect the performance. ■ Please refer to the following page for handling precautions when inserting and removing. ■ Because the product can disengage if dropped (or other impact), or by FPC routing, it is advised to secure the mated connectors to the board with housings and cushioning materials.

Handling Precautions for Connector Mating

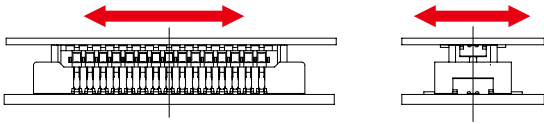

1) When aligning, look for the guide port without applying excessive force. If excessive force is applied, the housing may be damaged or shaved resulting in poor contact resistance, so please be careful.

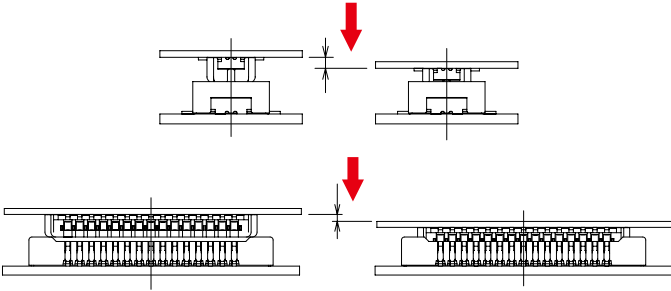

2) When fully aligned the connectors are parallel to each other with restricted longitudinal and lateral movement. Mate them parallel to each other.

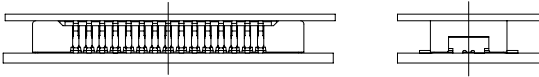

Handling Precautions for Connector Removal

1) Pull out the connectors parallel to each other.

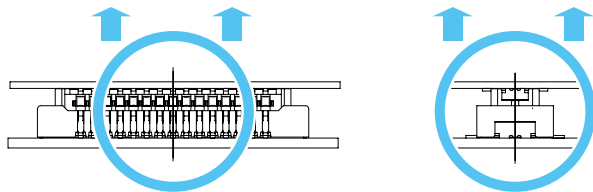

2) If the connector cannot be removed by pulling it out parallel to its mating partner, it can be removed by extracting the connector diagonally in the direction of the pitch as shown in the below figure.

However, there is a risk that the connector may break if the FPC is not rigid.
Please confirm the FPC rigidity at the time of trial production.

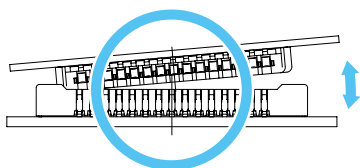

3) Do not remove the connector by pulling from the FPC corner as shown below.
Pulling from the FPC corner may result in connector and contact damage.

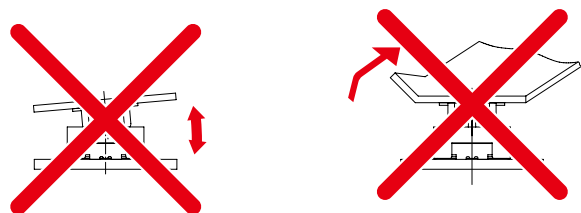

4) Insufficient FPC rigidity may result in connector breakage as shown in the below figure.
Please check the repeated mechanical operation of the FPC before use.
Please request for evaluation results of FPC rigidity and various items.

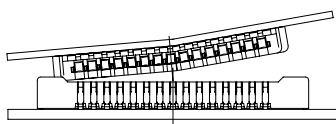

While Taking into Consideration

Specifications mentioned in this catalog are reference values.

When considering to order or use this product, please confirm the Drawing and Product Specifications sheets.

Use an appropriate cable when using the connector in combination with cables.

If considering usage of a non-specified cable, please contact your sales representative.

If assembly process is done by jigs & tools which are not identified by Hirose, assurance will not be given.

If considering usage for below mentioned applications, please contact your sales representative.

In cases where the application will demand a high level of reliability, such as automotive, medical instruments, public infrastructure, aerospace/ defense etc. Hirose must review before assurance of reliability can be given.