

NOTES:

1. Material : 302 SS
2. Finish : None
3. Total Coils : 6.500
4. Ends : Closed
5. Wind Direction : RHW
6. All Drawing Dimensions are in Inches [mm]

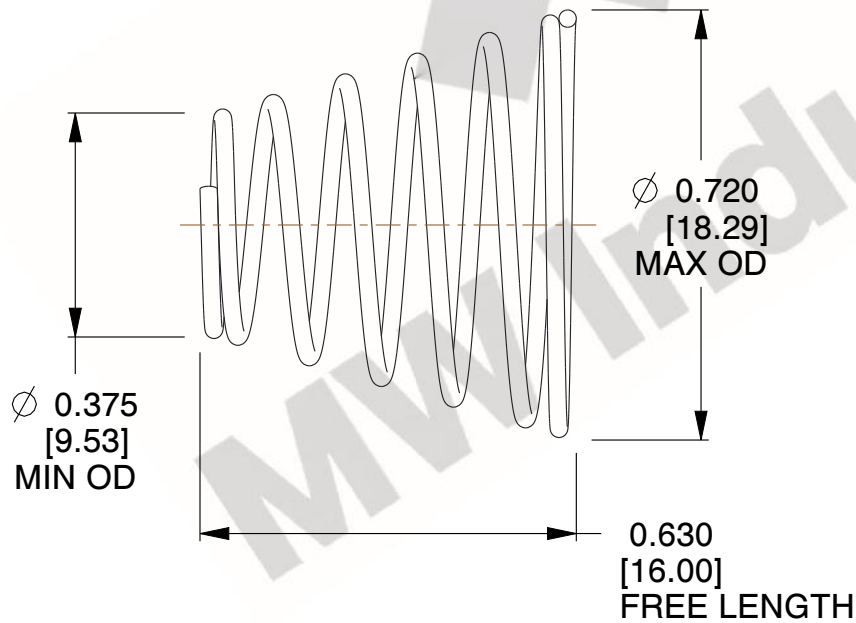

ϕ 0.029 [0.74] WIRE DIA.

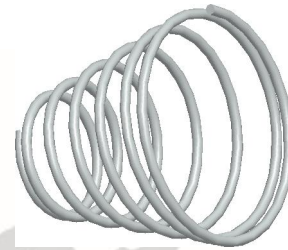
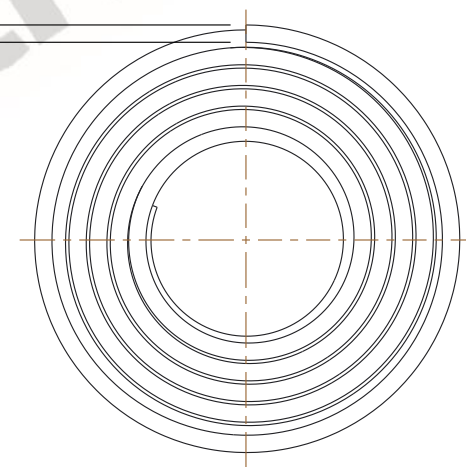

COMPONENT		TAPERED SPRINGS	
TA-7025S		UNIT	
		INCH [mm]	
		SHEET	
TAPERED SPRINGS		1 of 1	