

NOTES:

1. Material : Stainless Steel
2. Total Coils : 3.500
3. Solid Height : 0.450 (in)
4. Finish : ZINC
5. Ends : Closed
6. All Drawing Dimensions are in Inches [mm]

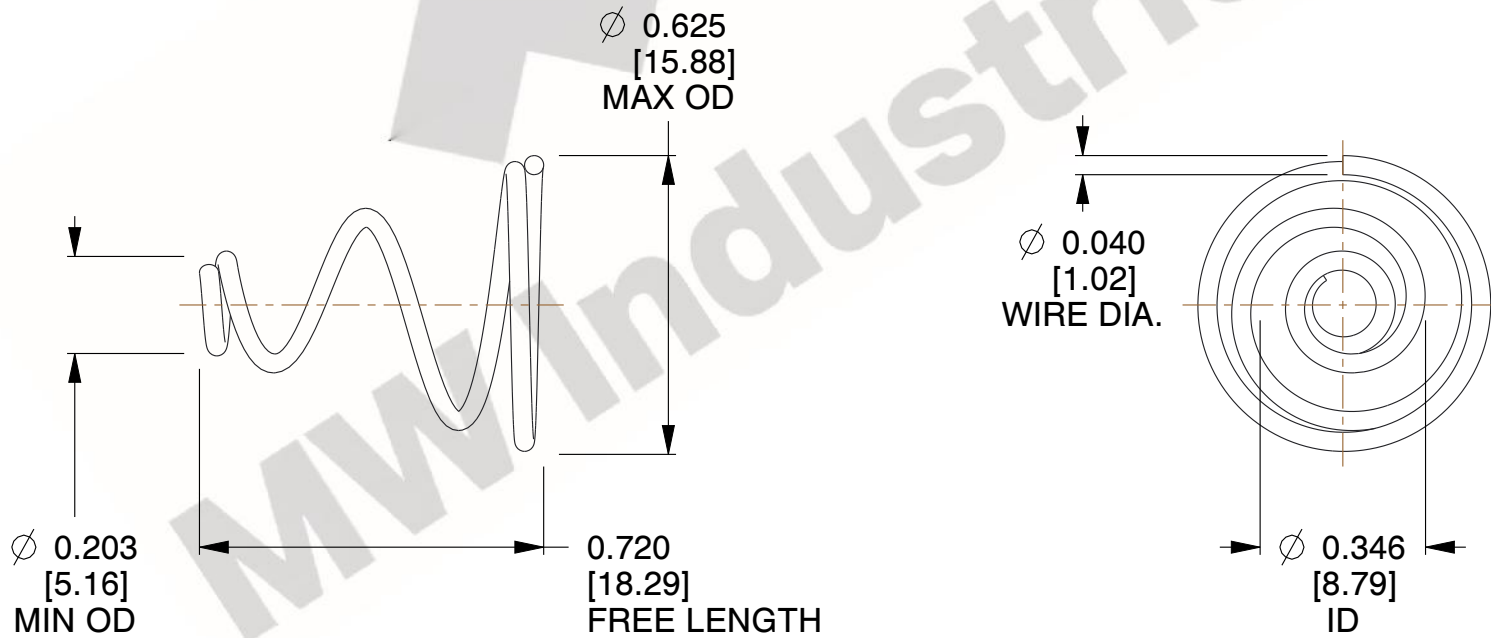
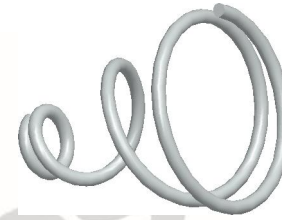

COMPONENT		TAPERED SPRINGS	
TA-2204CS		UNIT	INCH [mm]
		SHEET	1 of 1
TAPERED SPRINGS			