



**2SC3303-O**  
**2SC3303-Y**

**NPN**  
**Plastic-Encapsulate**  
**Transistors**

**Features**

- Low Collector Saturation Voltage
- High Speed Switching Time
- Epoxy meets UL 94 V-0 flammability rating
- Moisture Sensitivity Level 1
- Halogen free available upon request by adding suffix "-HF"
- Thermal Resistance from junction to ambient:125°C/W

**Maximum Ratings**

Symbol	Rating	Rating	Unit
V <sub>CEO</sub>	Collector-Emitter Voltage	80	V
V <sub>CBO</sub>	Collector-Base Voltage	100	V
V <sub>EBO</sub>	Emitter-Base Voltage	7.0	V
I <sub>C</sub>	Collector Current	5	A
P <sub>C</sub>	Collector power dissipation	1.0	W
T <sub>J</sub>	Junction Temperature	150	°C
T <sub>STG</sub>	Storage Temperature	-55 to +150	°C

**Electrical Characteristics @ 25°C Unless Otherwise Specified**

Symbol	Parameter	Min	Typ	Max	Units
V <sub>(BR)CBO</sub>	Collector-base Breakdown Voltage (I <sub>C</sub> =100µAdc, I <sub>E</sub> =0)	100	---	---	Vdc
V <sub>(BR)CEO</sub>	Collector-Emitter Breakdown Voltage (I <sub>C</sub> =100mAdc, I <sub>B</sub> =0)	80	---	---	Vdc
V <sub>(BR)EBO</sub>	Emitter-base Breakdown Voltage (I <sub>E</sub> =100µAdc, I <sub>C</sub> =0)	7	---	---	Vdc
I <sub>CBO</sub>	Collector-Base Cutoff Current (V <sub>CB</sub> =100Vdc, I <sub>E</sub> =0)	---	---	1.0	µAdc
I <sub>EBO</sub>	Emitter-Base Cutoff Current (V <sub>EB</sub> =7Vdc, I <sub>C</sub> =0)	---	---	1.0	µAdc
h <sub>FE</sub>	DC Current Gain (I <sub>C</sub> =1Adc, V <sub>CE</sub> =1.0Vdc) (I <sub>C</sub> =3Adc, V <sub>CE</sub> =1.0Vdc)	70	---	240	---
V <sub>CE(sat)</sub>	Collector-Emitter Saturation Voltage (I <sub>C</sub> =3Adc, I <sub>B</sub> =150mAdc)	---	---	0.4	Vdc
V <sub>BE(sat)</sub>	Base-Emitter Saturation Voltage (I <sub>C</sub> =3Adc, I <sub>B</sub> =150mAdc)	---	---	1.2	Vdc
f <sub>T</sub>	Transition Frequency (V <sub>CE</sub> =4Vdc, I <sub>C</sub> =1Adc)	---	20	---	MHz
C <sub>ob</sub>	Collector output capacitance (V <sub>CB</sub> =10Vdc, I <sub>E</sub> =0, f=1.0MHz)	---	80	---	pF

**CLASSIFICATION OF H<sub>FE</sub>(T)**

Rank	O	Y
Range	70-140	120-240

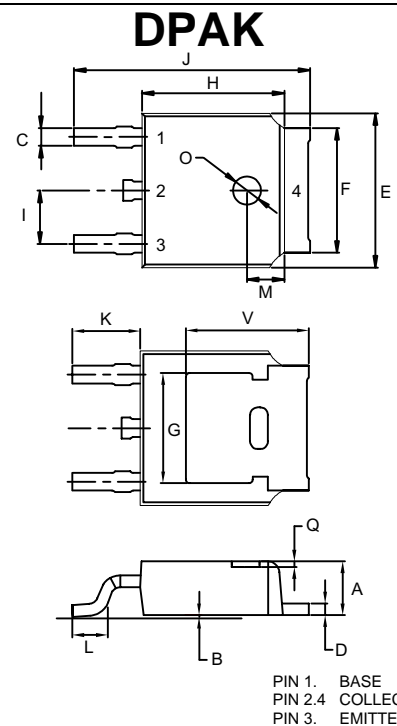

DIM	DIMENSIONS				NOTE
	INCHES		MM		
A	0.087	0.094	2.20	2.40	
B	0.000	0.005	0.00	0.13	
C	0.026	0.034	0.66	0.86	
D	0.018	0.023	0.46	0.58	
E	0.256	0.264	6.50	6.70	
F	0.201	0.215	5.10	5.46	
G	0.190		4.83		
H	0.236	0.244	6.00	6.20	
I	0.086	0.094	2.18	2.39	
J	0.386	0.409	9.80	10.40	
K	0.114		2.90		
L	0.055	0.067	1.40	1.70	
M	0.063		1.60		
O	0.043	0.051	1.10	1.30	
Q	0.000	0.012	0.00	0.30	
V	0.211		5.35		

# Typical Characteristics

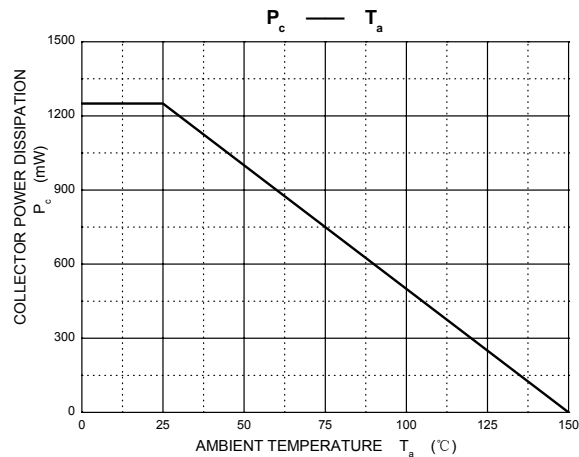
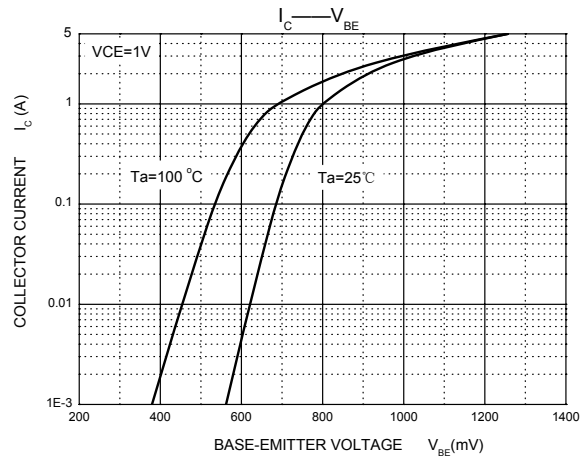
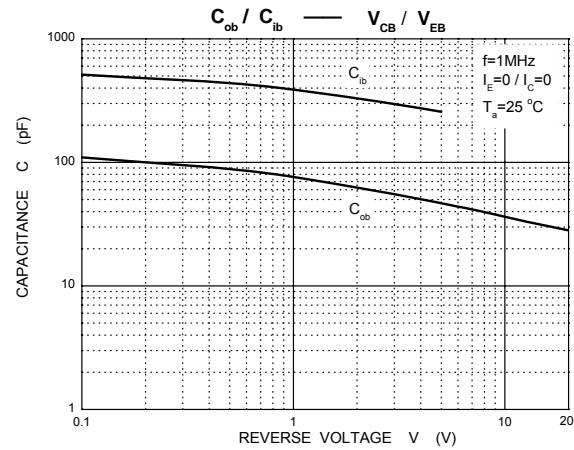
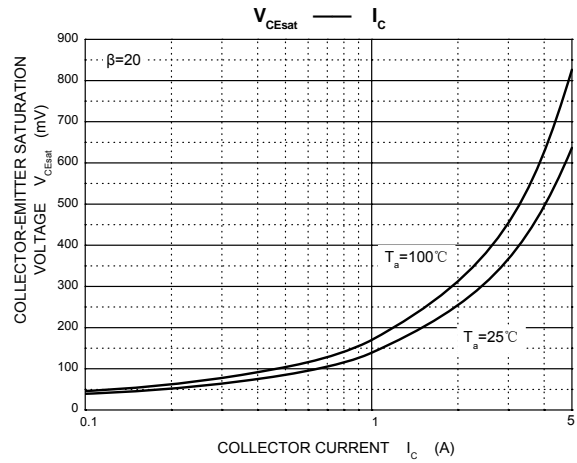
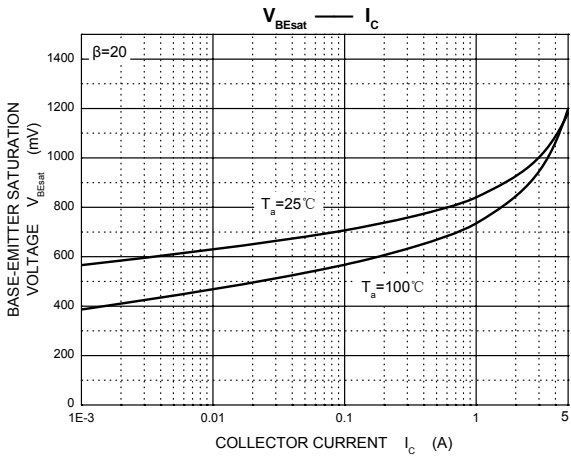
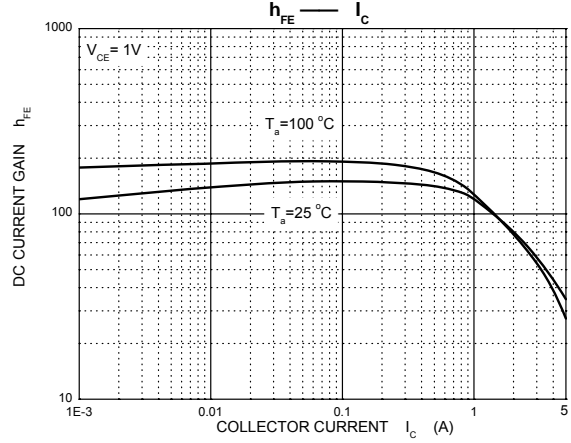
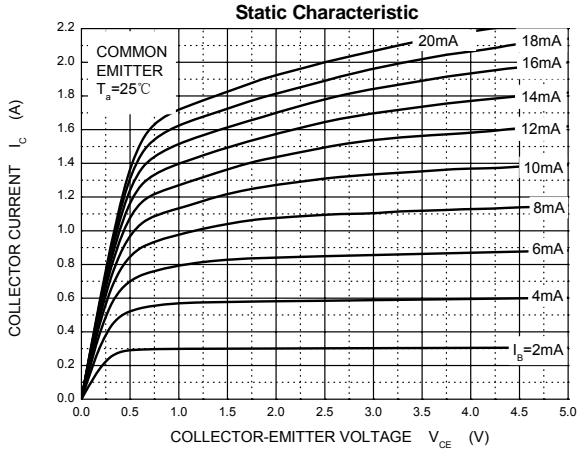



**Ordering Information :**

Device	Packing
Part Number-TP	Tape&Reel: 2.5Kpcs/Reel

Note : Adding "-HF" suffix for halogen free, eg. Part Number-TP-HF

**\*\*\*IMPORTANT NOTICE\*\*\***

**Micro Commercial Components Corp.** reserves the right to make changes without further notice to any product herein to make corrections, modifications , enhancements , improvements , or other changes . **Micro Commercial Components Corp .** does not assume any liability arising out of the application or use of any product described herein; neither does it convey any license under its patent rights ,nor the rights of others . The user of products in such applications shall assume all risks of such use and will agree to hold **Micro Commercial Components Corp .** and all the companies whose products are represented on our website, harmless against all damages.

**\*\*\*LIFE SUPPORT\*\*\***

MCC's products are not authorized for use as critical components in life support devices or systems without the express written approval of Micro Commercial Components Corporation.

**\*\*\*CUSTOMER AWARENESS\*\*\***

Counterfeiting of semiconductor parts is a growing problem in the industry. Micro Commercial Components (MCC) is taking strong measures to protect ourselves and our customers from the proliferation of counterfeit parts. MCC strongly encourages customers to purchase MCC parts either directly from MCC or from Authorized MCC Distributors who are listed by country on our web page cited below. Products customers buy either from MCC directly or from Authorized MCC Distributors are genuine parts, have full traceability, meet MCC's quality standards for handling and storage. **MCC will not provide any warranty coverage or other assistance for parts bought from Unauthorized Sources.** MCC is committed to combat this global problem and encourage our customers to do their part in stopping this practice by buying direct or from authorized distributors.