

NOTES:

1. Material : Spring Steel
2. Total Coils : 4.000
3. Solid Height : 0.450 (in)
4. Finish : ZINC
5. Ends : Closed
6. All Drawing Dimensions are in Inches [mm]

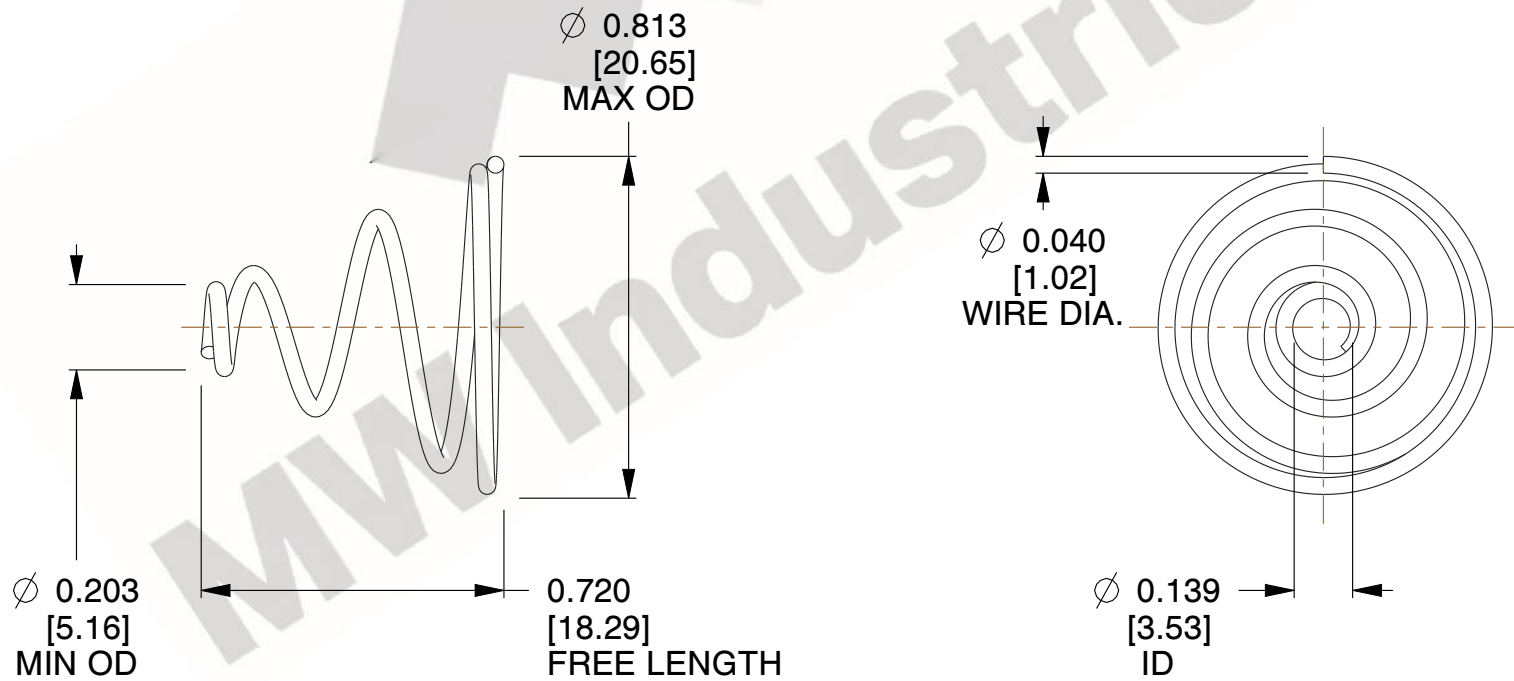

COMPONENT TAPERED SPRINGS