

MOUNTING LAYOUT

TOLERANCE: ±.005 [±0.13] UNLESS OTHERWISE SPECIFIED.

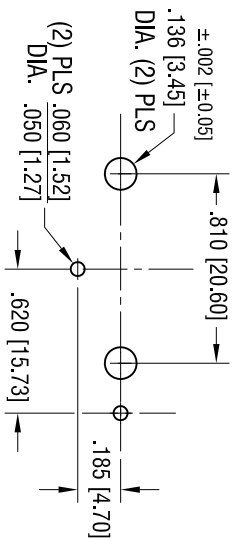

SECTION A-A

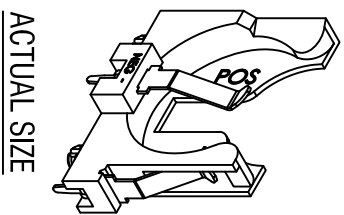
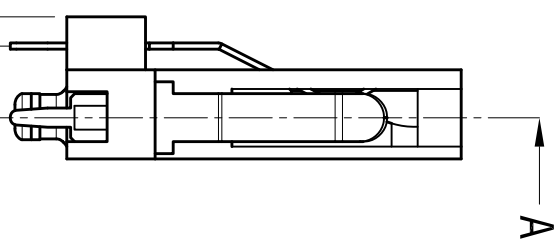
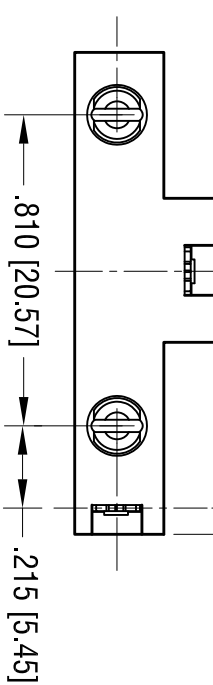
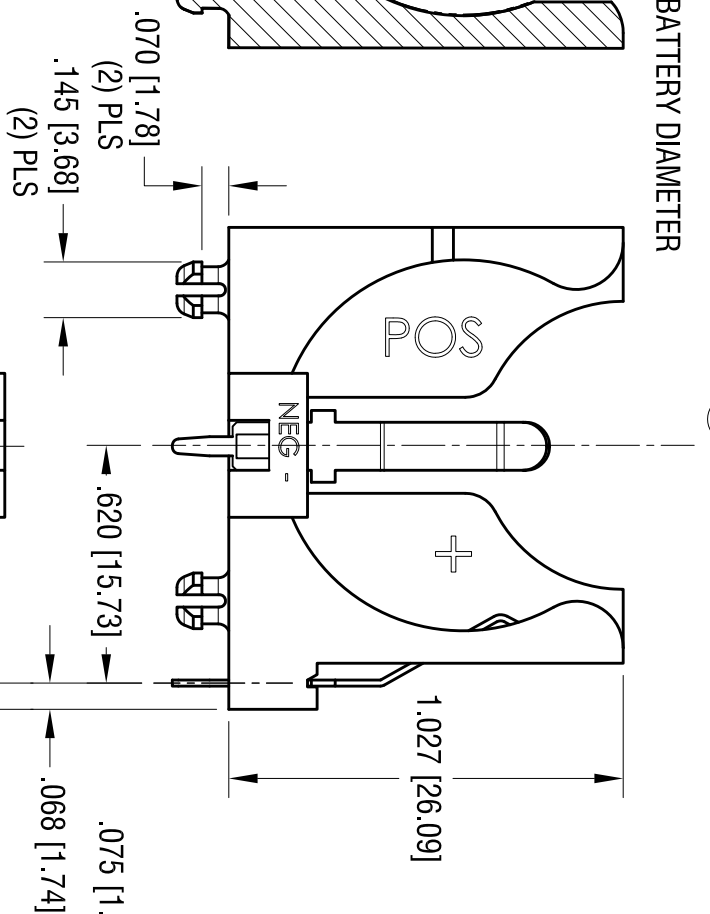
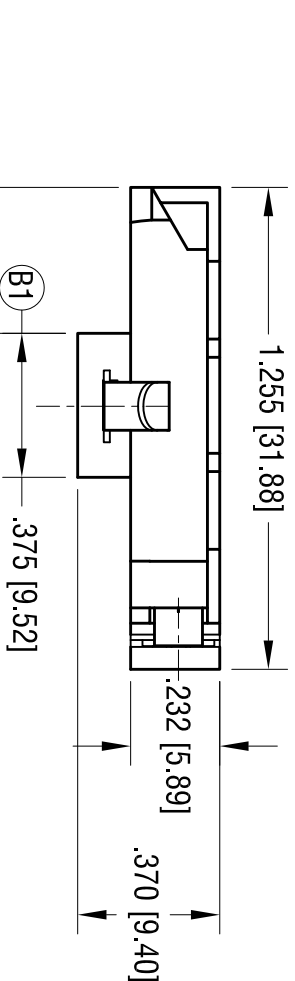
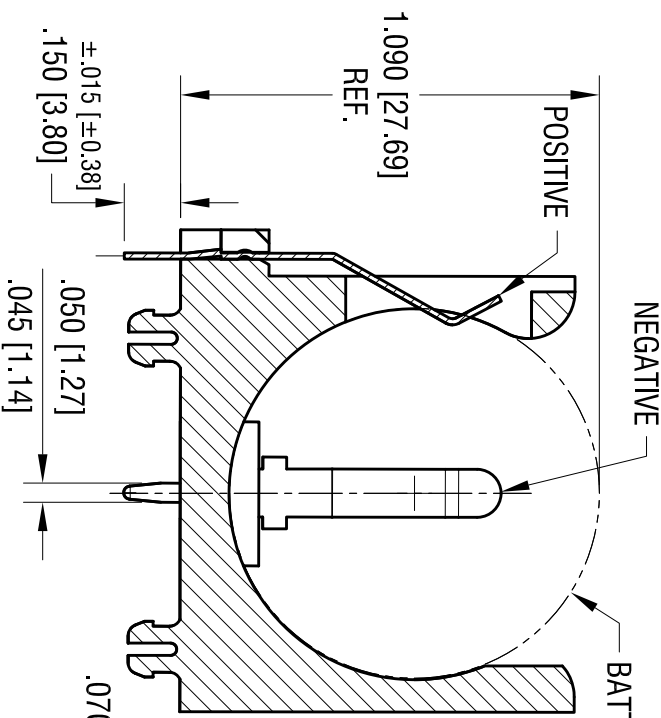

ACTUAL SIZE

THIS DOCUMENT IS THE PROPERTY OF KEYSTONE ELECTRONICS CORP. NO PART OF THIS DOCUMENT IS TO BE REPRODUCED, DISTRIBUTED OR USED AS A BASIS FOR MANUFACTURE WITHOUT PRIOR WRITTEN PERMISSION FROM KEYSTONE ELECTRONICS CORP.

KEYSTONE ELECTRONICS CORP.

www.keystone.com • ASTORIA, N.Y. 11105-2017 • Tel (718) 956-8900

PART NAME

VERTICAL 24mm COIN CELL HOLDER

MATERIAL

AS NOTED

FINISH

AS NOTED

TOLERANCES	INCH	[MM]	CODE	DWG NO.
DECIMAL	± .010	[± 0.25]	C	1068
ANGULAR	± 1°			
UNLESS OTHERWISE SPECIFIED				

DRN BY	DATE
NT	12.03.11
APP'D	SCALE
	2X

DATE	DESCRIPTION	REV.
4.18.12	CHANGE AS PER ECN 12-049	A
4.23.12	CHANGE AS PER ECN 12-054 ADD (B1) (B2) DIMENSIONS	B
8.02.13	CHANGE AS PER ECN 13-064	C
4.28.14	CHANGE AS PER ECN 14-046	D

- NOTES:
- BASE:
MAT'L - PBT (UL 94V-0) BLACK
CONTACTS:
MAT'L - .016 [0.40] THK STAINLESS STEEL
FINISH - TIN NICKEL PLATE.