

Build Your Own Clone Li'l Reverb Kit Instructions



Warranty:

BYOC, Inc. guarantees that your kit will be complete and that all parts and components will arrive as described, functioning and free of defect. Soldering, clipping, cutting, stripping, or using any of the components in any way voids this guarantee. BYOC, Inc. guarantees that the instructions for your kit will be free of any major errors that would cause you to permanently damage any components in your kit, but does not guarantee that the instructions will be free of typos or minor errors. BYOC, Inc. does not warranty the completed pedal as a whole functioning unit, nor do we warranty any of the individual parts once they have been used. If you have a component that is used, but feel it was defective prior to you using it, we reserve the right to determine whether or not the component was faulty upon arrival. Please direct all warranty issues to: sales@buildyourownclone.com This would include any missing parts issues.

Return:

BYOC, Inc. accepts returns and exchanges on all products for any reason, as long as they are unused. We do not accept partial kit returns. Returns and exchanges are for the full purchase price less the cost of shipping and/or any promotional pricing. Return shipping is the customer's responsibility. This responsibility not only includes the cost of shipping, but accountability of delivery as well. Please contact sales@buildyourownclone.com to receive a return authorization before mailing.

Tech Support:

BYOC, Inc. makes no promises or guarantees that you will successfully complete your kit in a satisfactory manner. Nor does BYOC, Inc. promise or guarantee that you will

receive any technical support. Purchasing a product from BYOC, Inc. does not entitle you to any amount of technical support. BYOC, Inc. does not promise or guarantee that any technical support you may receive will be able to resolve any or all issues you may be experiencing.

That being said, we will do our best to help you as much as we can. Our philosophy at BYOC is that we will help you only as much as you are willing to help yourself. We have a wonderful and friendly DIY discussion forum with an entire section devoted to the technical support and modifications of BYOC kits.

www.byoelectronics.com/board

When posting a tech support thread on the BYOC forum, please post it in the correct lounge, and please title your thread appropriately. If everyone titles their threads "HELP!" then it makes it impossible for the people who are helping you to keep track of your progress. A very brief description of your specific problem will do. It will also make it easier to see if someone else is having or has had the same problem as you. The question you are about to ask may already be answered. Here is a list of things that you should include in the body of your tech support thread:

1. A detailed explanation of what the problem is. (more than, "It doesn't work, help")
2. Pic of the topside of your PCB.
3. Pic of the underside of your PCB.
4. Pic that clearly shows your footswitch/jack wiring and the wires going to the PCB
5. A pic that clearly shows your wiring going from the PCB to the pots and any other switches(only if your kit has non-PC mounted pots and switches)
6. Is bypass working?
7. Does the LED come on?
8. If you answered yes to 6 and 7, what does the pedal do when it is in the "on" position?
9. Battery or adapter (if battery, is it good? If adapter, what type?)

Also, please only post photos that are in focus.

Copyrights:

All material in this document is copyrighted 2015 by BYOC, Inc.

Li'l Reverb Kit Instruction Index

Parts Checklist.....	page 4
Populating the Circuit Board.....	page 7
Enclosure Assembly.....	page 14
Wiring.....	page 18
Operation Overview.....	page 23
Schematic.....	page 24
PCB Back Trace Photo.....	page 25

Parts Checklist for the Li'l Reverb Kit

Resistors

- 1 - 100 Ohm/101 (Black/Brown/Black/Black/Brown)
- 1 - 470 Ohm/471 (Yellow/Purple/Black/Black/Brown)
- 5 - 1k/102 (Brown/Black/Black/Brown/Brown)
- 2 - 4k7 /472 (Yellow/Purple/Black/Brown/Brown)
- 5 - 10k/103 (Brown/Black/Black/Red/Brown)
- 6 - 22k/223 (Red/Red/Black/Red/Brown)
- 3 - 100k/104 (Brown/Black/Black/Orange/Brown)
- 1 - 470k/474 (Yellow/Purple/Black/Orange/Brown)

Visit www.byocelectronics.com/resistorcodes.pdf for more information on how to differentiate resistors.

Capacitors:

- 1 - 15pF - 22pF Ceramic Disc capacitor (round yellow) (15pF, 18pF, 20pF, 22pF)
- 1 - 1n0/.001uF Film cap (May say "102" on the body)
- 1 - 10n/.01uF Film cap (May say "103" on the body)
- 2 - 15n/.015uF Film cap (May say "153" on the body)
- 1 - 47n/.047uF Film cap (May say "473" on the body)
- 2 - 220n/.22uF Film Cap (May say "224" on the body)
- 3 - 1uF Aluminum Electrolytic
- 1 - 10uF Aluminum Electrolytic
- 2 - 47uF Aluminum Electrolytic

Visit www.byocelectronics.com/capcodes.pdf for more info on how to differentiate capacitors.

Diodes:

- 1 - 1N4001

IC:

- 1 - 4558
- 1 - FV-1 Chip
- 1 - 32768Hz Crystal Oscillator

Potentiometers: SNAP THE SMALL TABS ON THE TOP OF THE POTS OFF WITH A PAIR OF NEEDLE NOSE PLIERS

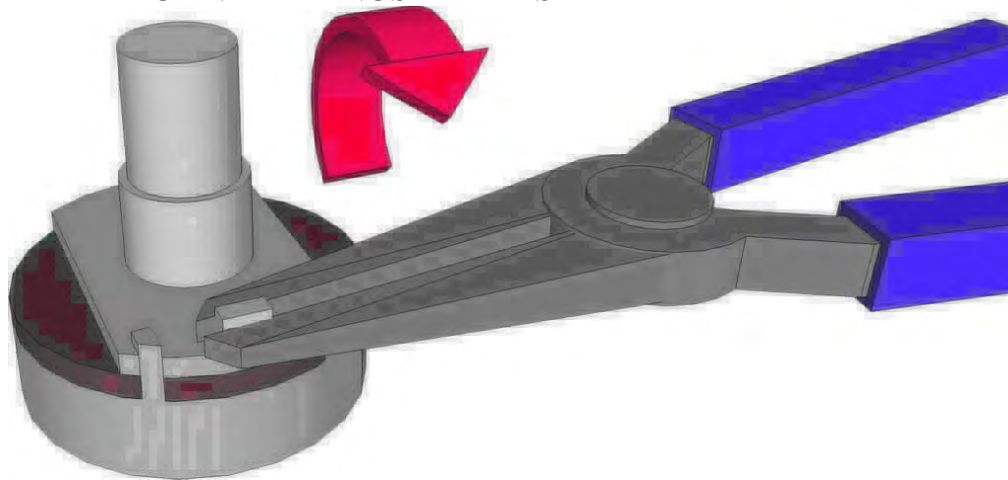

2 - B50k (DELAY and REVERB)

Hardware:

- 1 - predrilled enclosure w/ 4 screws
- 1 - Li'l Reverb PCB
- 1 - 3pdt footswitch
- 2 - enclosed Jacks
- 4 - rubber bumpers
- 2 - lock washers (for in and out jacks)
- hook-up wire

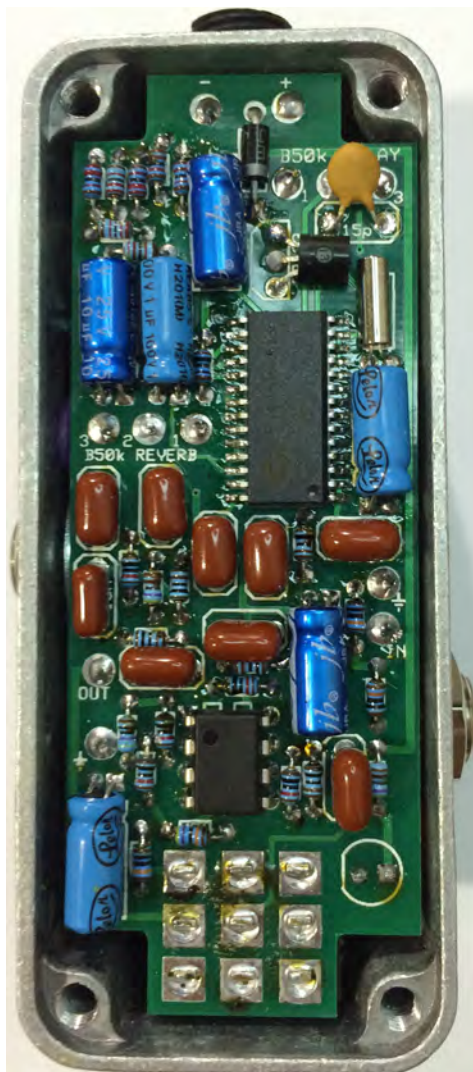

Your build should look similar to this when you're finished.

Step 2: Add the crystal oscillator. Bend the leads and lay the oscillator along the screenprint before soldering.

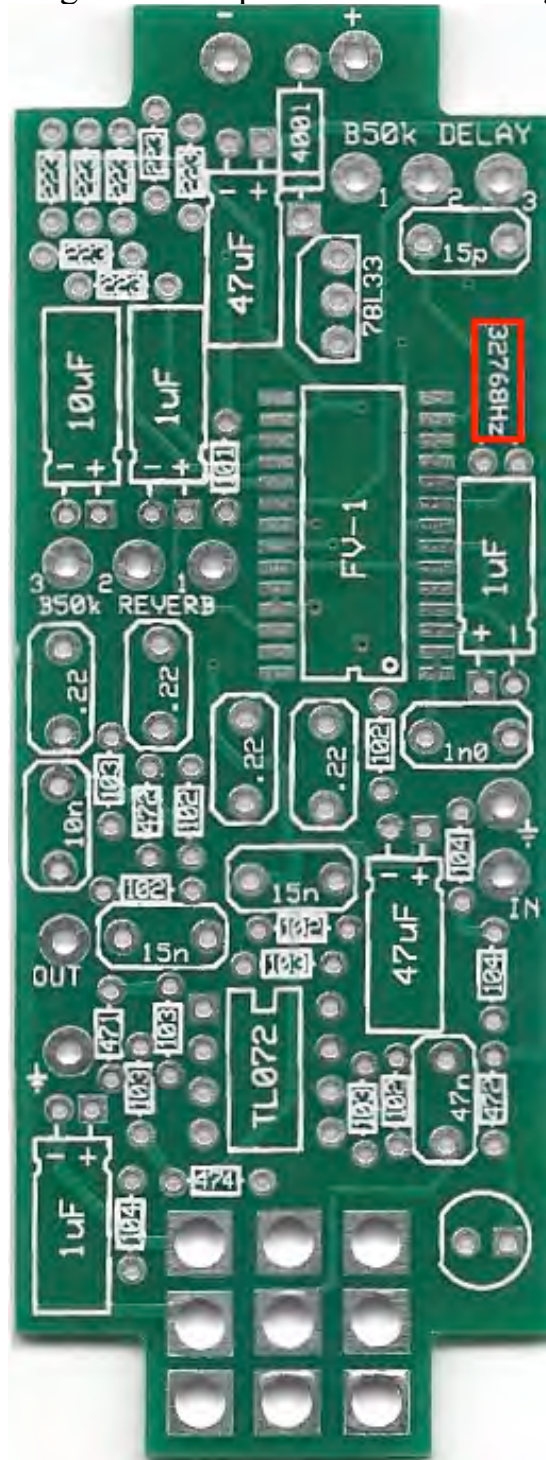

Step 3: Add all the resistors. Resistors are not polarized and can be inserted in either direction.

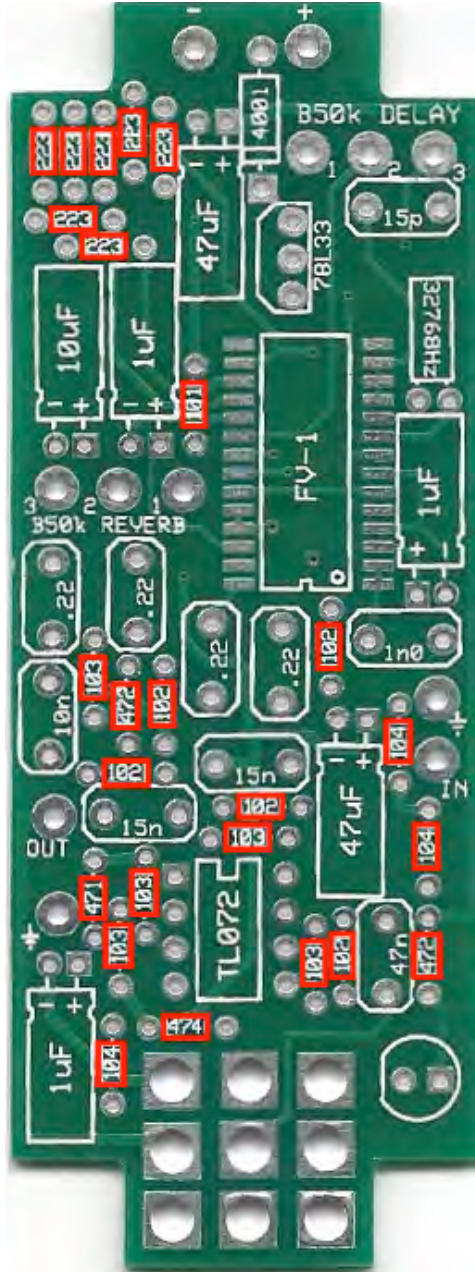

Step 4: Add the diode. Be sure to match the end of the diode with the stripe to the layout on the PCB. The striped end should go in the square solder pad.

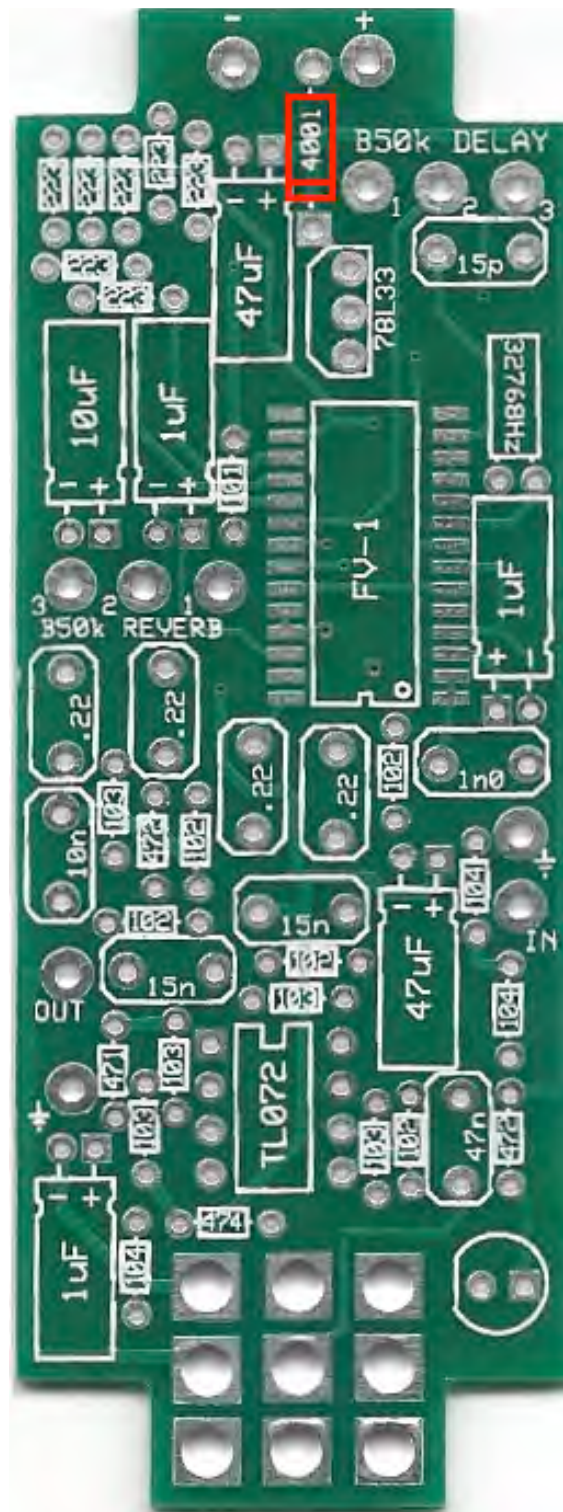

Step 5: Add the IC. Be sure to orient it correctly. There may be a notch on the IC between pins 1 and 8. Line that up with the screenprint on the PCB. If your IC does not have a notch, look for a dot to indicate pin 1. Pin one on the PCB will be a square hole.

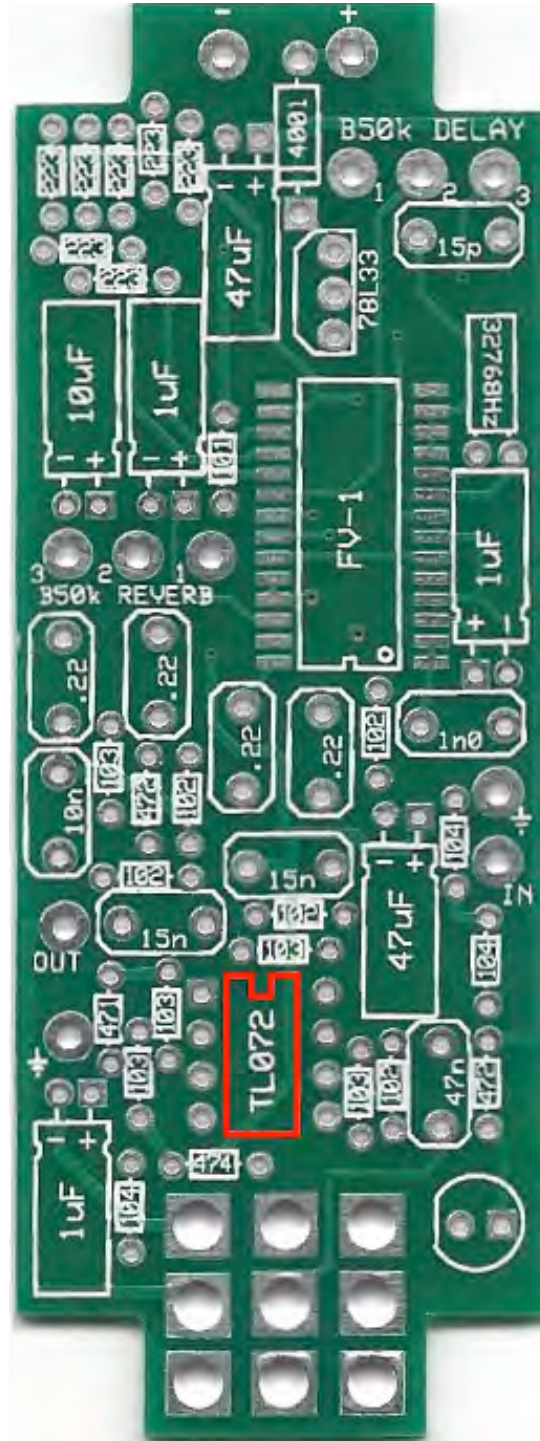

Step 6: Add the 78L33 Voltage Regulator. Be sure to match the flat side of the transistor with the flat side on the screenprint.

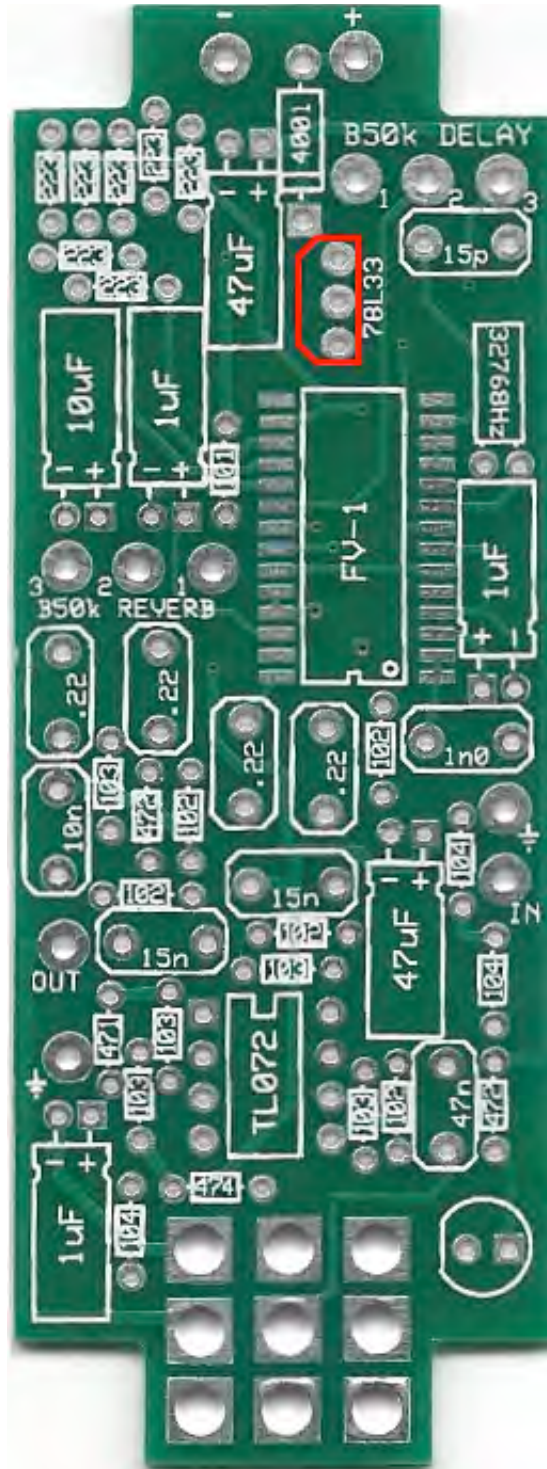

Step 7: Add the film and ceramic disc capacitors. These are non-polarized and can go in either direction. The ceramic disc capacitor is highlighted in yellow.

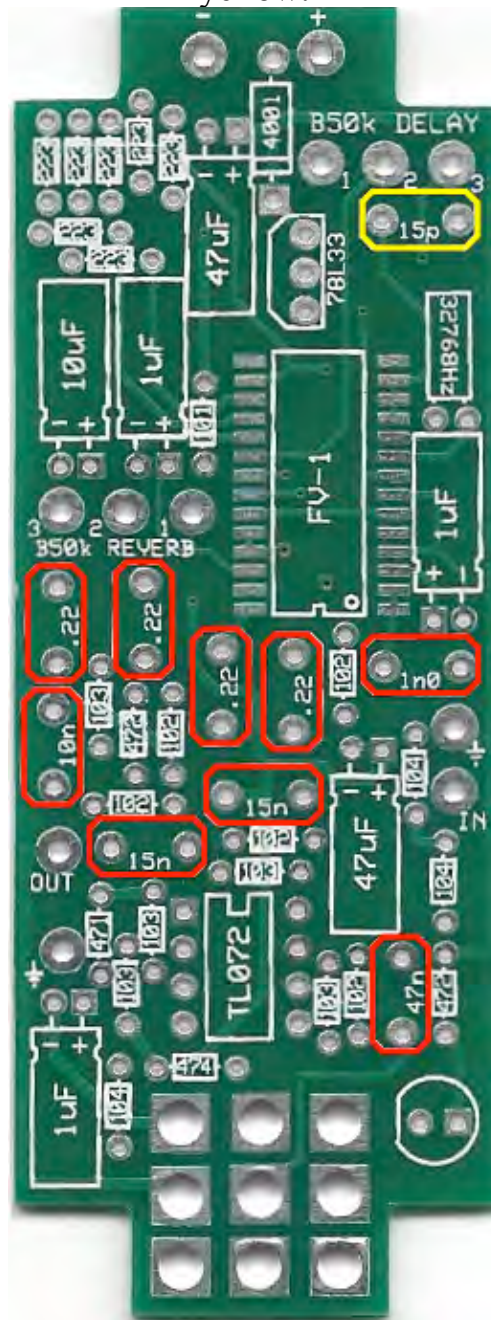

Step 8: Add the aluminum electrolytic capacitors. These ARE polarized, meaning there is a positive and negative end. The positive side will have a longer lead and goes in the square solder pad. The negative side will have a shorter lead and a stripe running along the body of the cap, and goes in the round solder pad. Before soldering, bend the capacitor so it is laying down like below

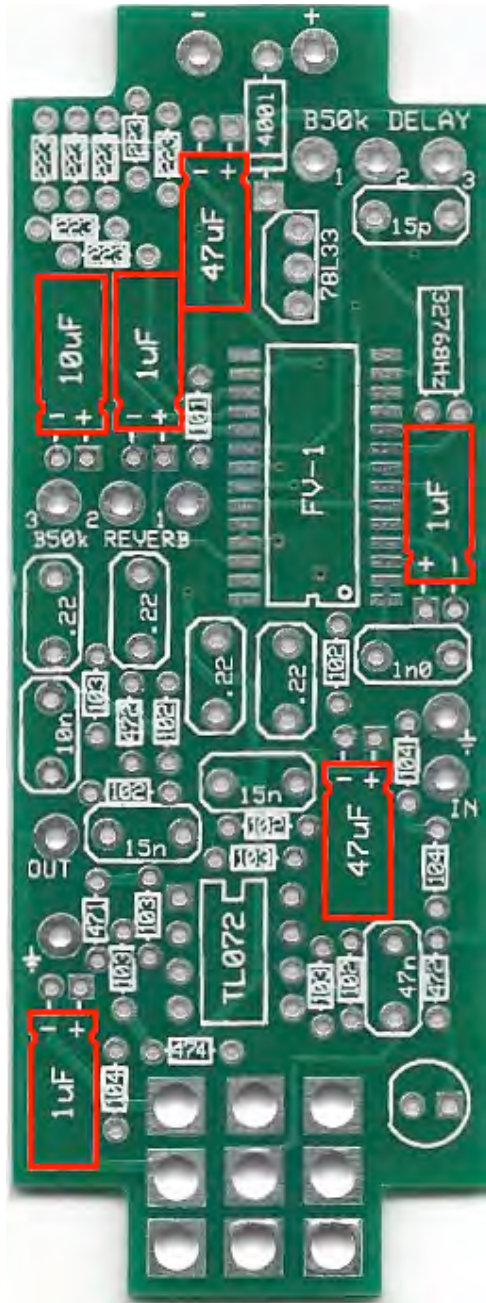

Enclosure Hardware Assembly

Step 1: Mount the DC adapter jack.

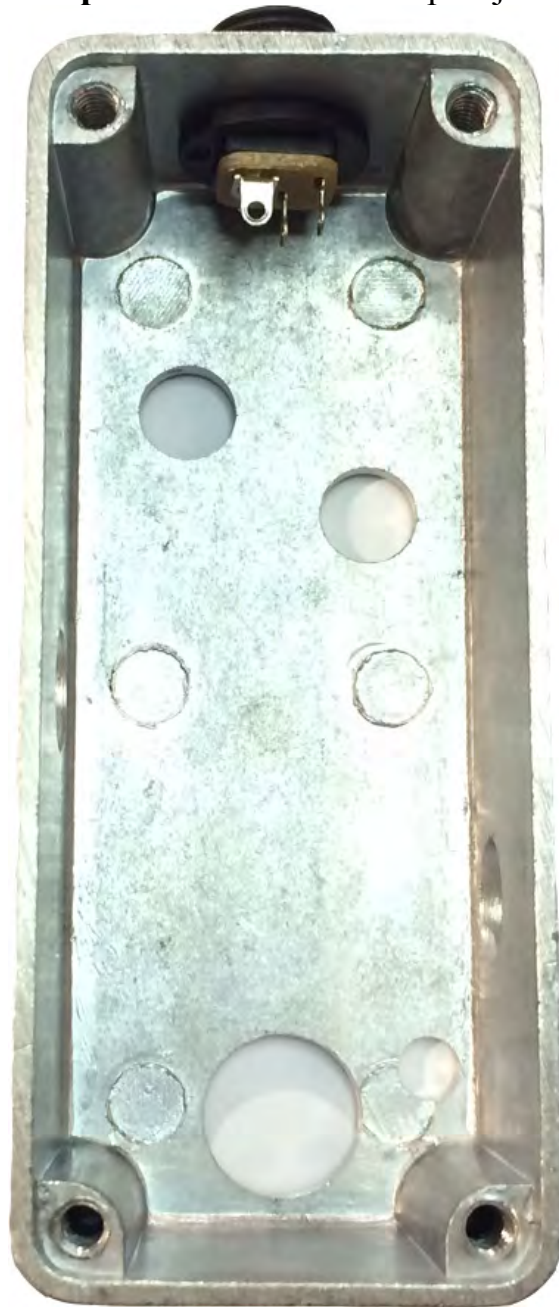

Step 2: Mount the potentiometer. You will mount it with the solder lugs facing towards the DC Jack.

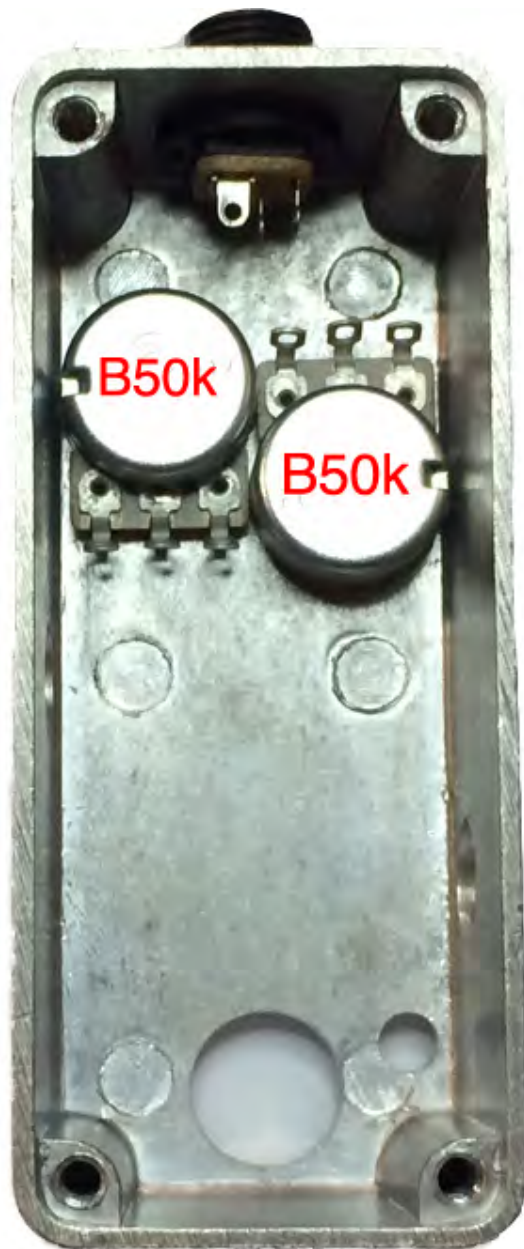

Step 3: Mount the Audio Jacks. You want to orient them so that the SLEEVE terminals (beveled corner of the jack) are facing away from each other. If looking at the inside of the enclosure, the INPUT jack will have its sleeve terminal facing towards the AC jack. The OUTPUT jack will have its sleeve terminal facing towards the footswitch hole. The green arrows are pointing at the sleeves.

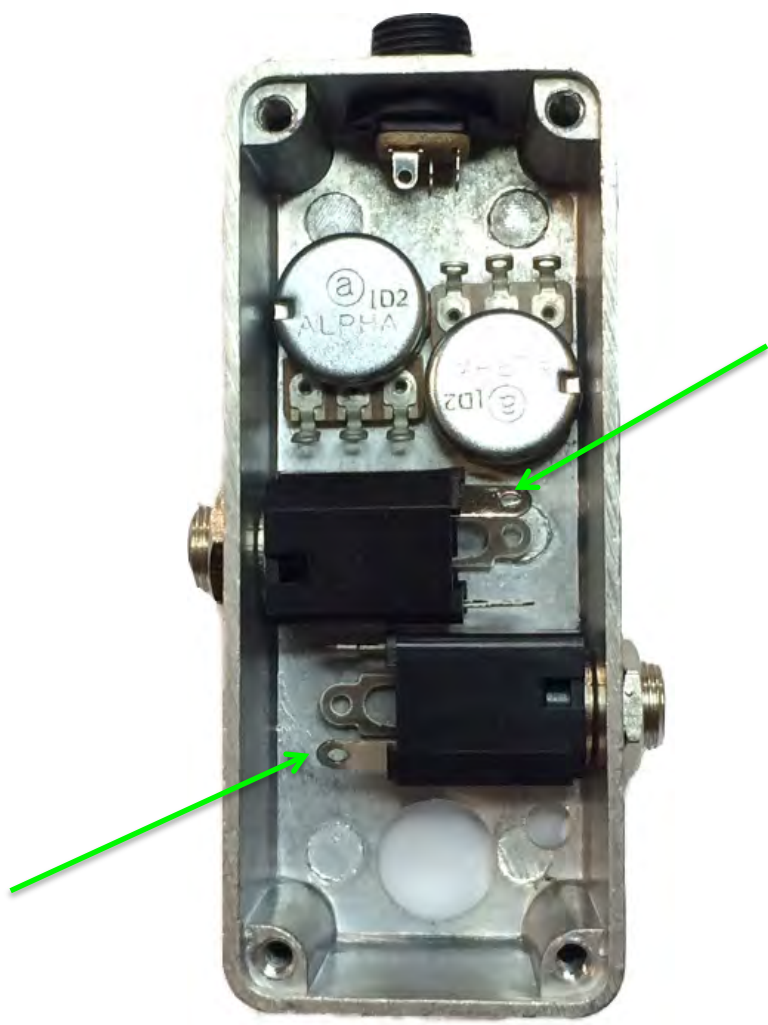

Step 4: Remove both nuts from the footswitch and mount the footswitch.

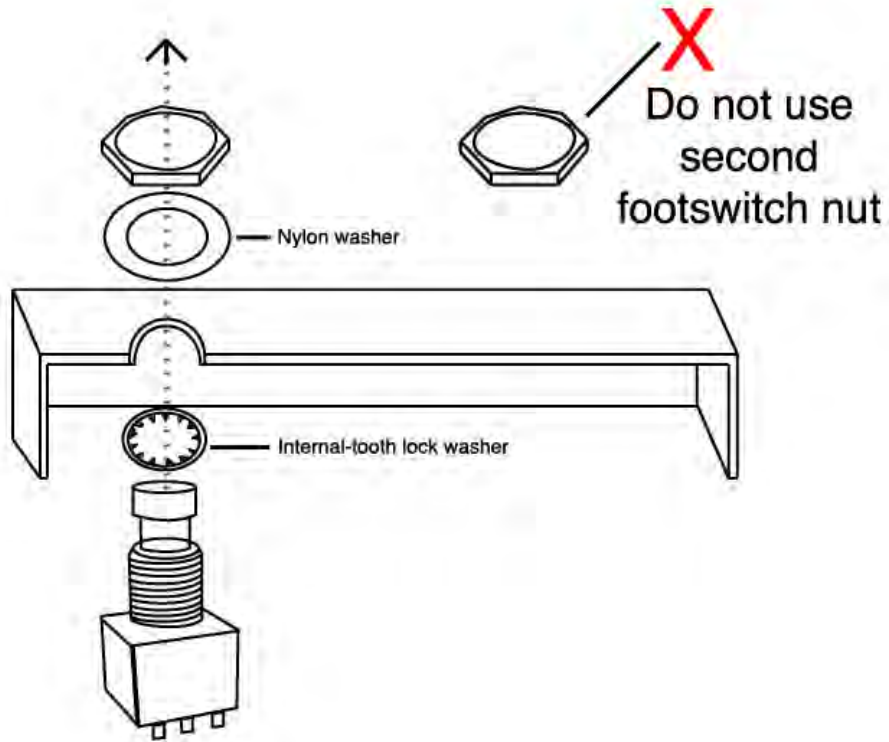

Orient the footswitch so that the flat sides of the solder lugs are like the diagram below.

NOTE: There are no actual number markings on the footswitch. There are two correct ways you can orient the footswitch. They are both 180 degrees of each other. Either way is fine. It does not matter as long as the flat sides of the solder lugs are running horizontal, not vertical.

FOOT SWITCH SOLDER LUG DESIGNATIONS

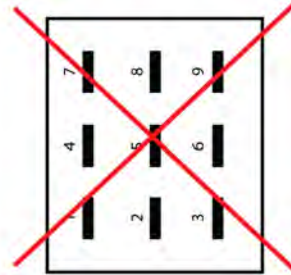
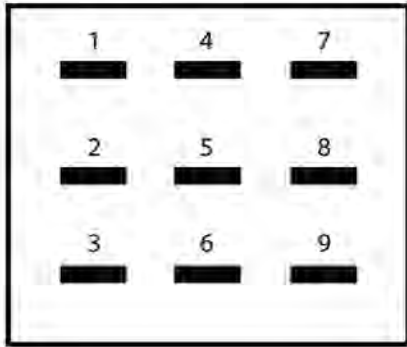

Wiring



FLIP PCB OVER!!!

STEP 1: Wire the PCB as shown in the diagram below. Make all connections to the back side of the PCB and solder on the top (screen printed) side of the PCB. Make the wires as short as possible but allow enough length so that if you need to do any trouble shooting later, you will be able to do so without having to remove all the enclosure mounted components.

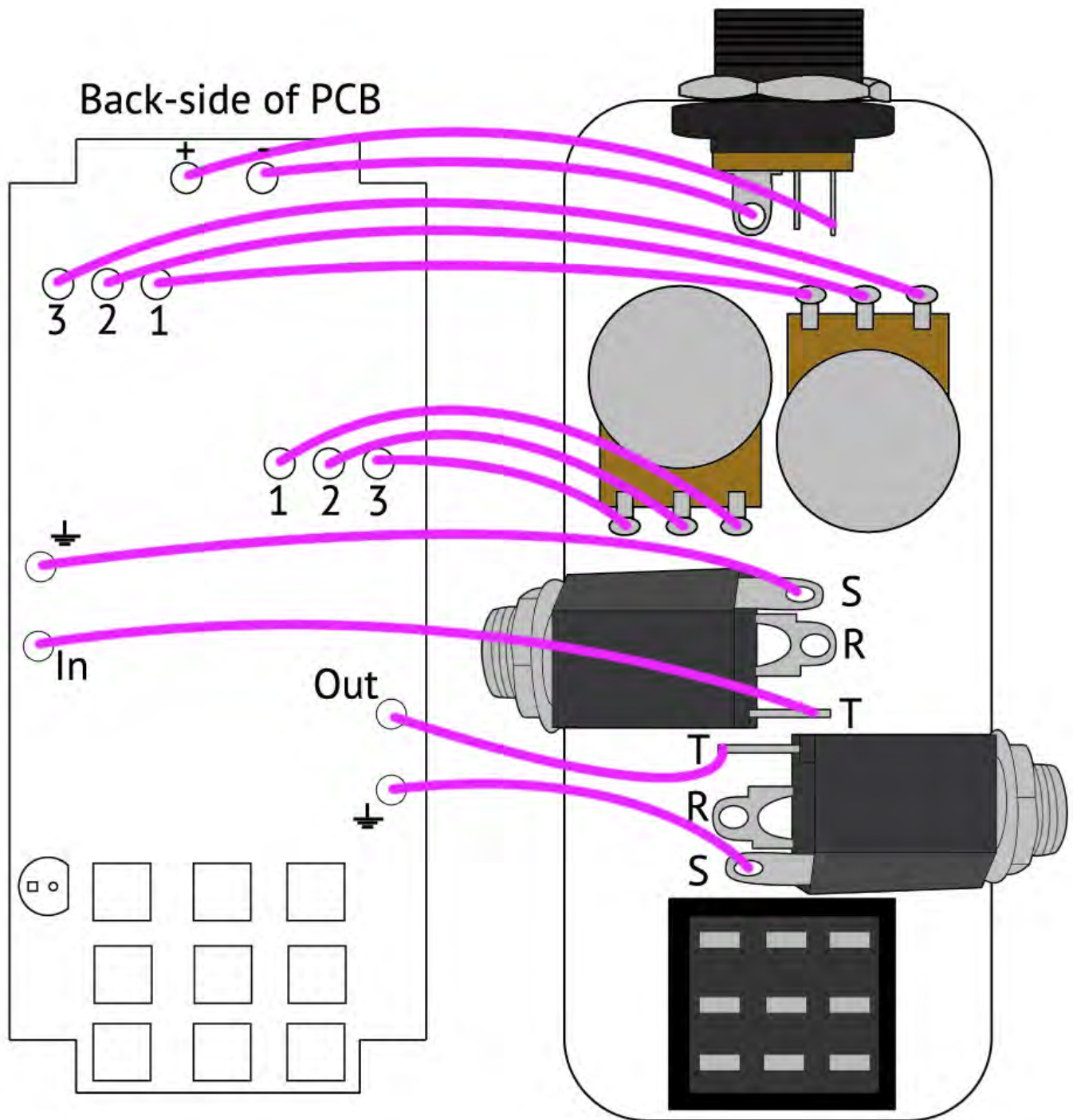

Step 2: Once the AC jack, potentiometer, and IN/OUT jacks are wired, insert the LED in its hole. **Insert the long lead into the square hole!!!** You might want to slightly bend the leads away from each other to keep them in the holes for now. **DO NOT SOLDER YET**

Step 3: Flip the PCB right-side-up, tuck the wires into the enclosure, and place the PCB onto the footswitch. **DO NOT SOLDER YET!!!!**

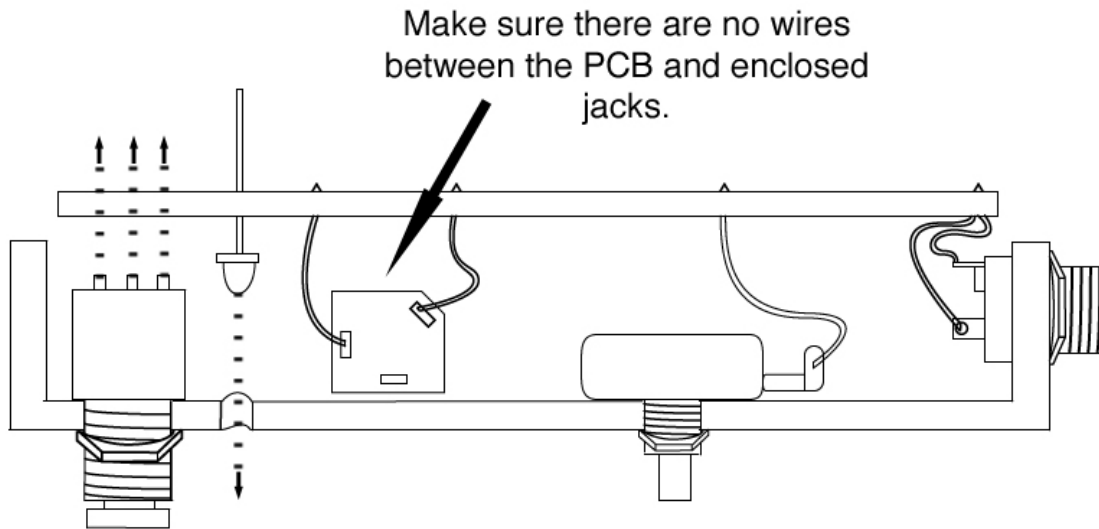

Buffalo Bill says, “Be sure to tuck really well!”

It is extremely important that when you place the PCB on the footswitch, you make sure to tuck all the wires out of the way so that that PCB can rest flush against the enclosed jacks and footswitch.

Step 4: Solder ONLY 1 of the footswitch lugs.

Your PCB should be recessed inside the enclosure about 1cm. It should be level.

Some of your components may be sticking up out of the enclosure just a bit, particularly the film capacitors. This is to be expected. This is OK. The lid has a deep recess.

If you need to adjust the position of the PCB so that it fits correctly, reheat the single solder joint you just made on the footswitch. Adjust the position of the PCB while keeping the solder joint hot. Remove the heat and hold the PCB in position while allowing the solder joint to cool completely. Now solder the rest of the footswitch lugs.

Step 5: Once you have your PCB positioned and soldered, guide the LED into its enclosure hole using the leads that are sticking up through the PCB. Once the LED is in position, solder and trim the excess leads.

Operating Overview



REVERB: Control the level of reverb.

DECAY: Controls how long the reverb lingers.

Power supply: 2.1mm negative tip.

Current Draw: 7.5mA

Input Impedance: 470k ohms

Output Impedance: 100k ohms

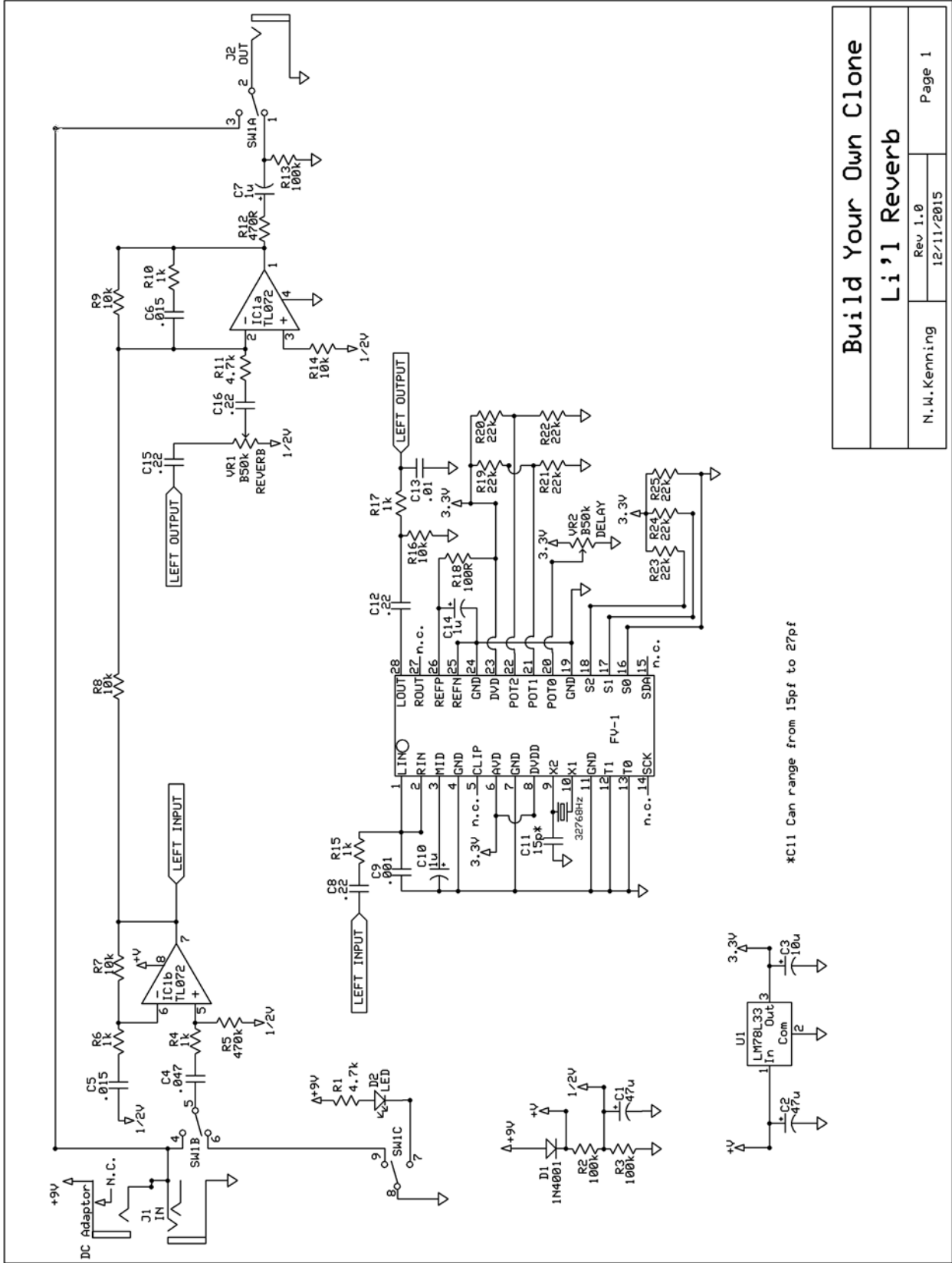

PCB Back Trace Photo



Please visit
<http://byoceletronics.com/board>
for any technical support

Copyright 2015
BYOC, Inc.