

# Silicon Carbide (SiC) Module – EliteSiC, 10 mohm SiC M2 MOSFET, 900 V, 2-PACK Half Bridge Topology, F1 Package

## Advance Information NXH010P90MNF1PTG, NXH010P90MNF1PG

The NXH010P120MNF1 is a power module containing an 10 mΩ/900 V SiC MOSFET half bridge and a thermistor in an F1 package.

### Features

- 10 mΩ/900 V SiC MOSFET Half Bridge
- Thermistor
- Options with Pre-applied Thermal Interface Material (TIM) and without Pre-applied TIM
- Press-fit Pins

### Typical Applications

- Solar Inverter
- Uninterruptible Power Supplies
- Electric Vehicle Charging Stations
- Industrial Power

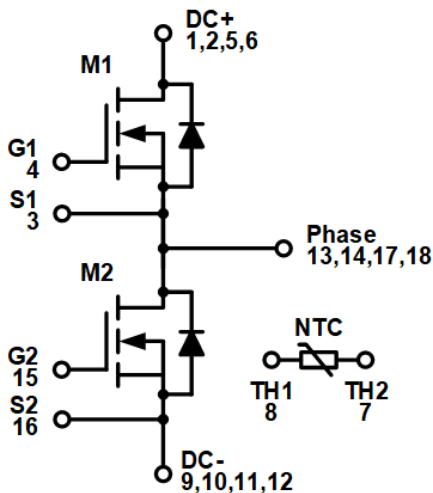
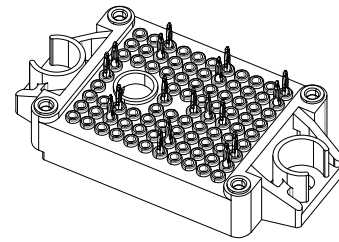
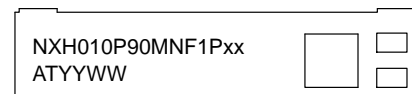

Figure 1. NXH010P90MNF1 Schematic Diagram



PIM18 33.8x42.5 (PRESS FIT)  
CASE 180BW

### MARKING DIAGRAM



NXH010P90MNF1PTG= Specific Device Code  
NXH010P90MNF1PG = Specific Device Code  
AT = Assembly & Test Site Code  
YYWW = Year and Work Week Code

### PIN CONNECTIONS

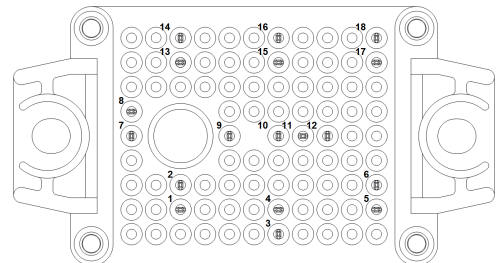

See Pin Function Description for pin names

### ORDERING INFORMATION

See detailed ordering and shipping information on page 4 of this data sheet.

This document contains information on a new product. Specifications and information herein are subject to change without notice.

# NXH010P90MNF1PTG, NXH010P90MNF1PG

## PIN FUNCTION DESCRIPTION

Pin	Name	Description
1	DC+	DC Positive Bus connection
2	DC+	DC Positive Bus connection
3	S1	Q1 Kelvin Emitter (High side switch)
4	G1	Q1 Gate (High side switch)
5	DC+	DC Positive Bus connection
6	DC+	DC Positive Bus connection
7	TH2	Thermistor Connection 2
8	TH1	Thermistor Connection 1
9	DC-	DC Negative Bus connection
10	DC-	DC Negative Bus connection
11	DC-	DC Negative Bus connection
12	DC-	DC Negative Bus connection
13	PHASE	Center point of half bridge
14	PHASE	Center point of half bridge
15	G2	Q2 Gate (Low side switch)
16	S2	Q2 Kelvin Emitter (High side switch)
17	PHASE	Center point of half bridge
18	PHASE	Center point of half bridge

## MAXIMUM RATINGS

Rating	Symbol	Value	Unit
<b>SiC MOSFET</b>			
Drain-Source Voltage	$V_{DSS}$	900	V
Gate-Source Voltage	$V_{GS}$	+18/-8	V
Continuous Drain Current @ $T_C = 80^\circ\text{C}$ ( $T_J = 175^\circ\text{C}$ )	$I_D$	154	A
Pulsed Drain Current ( $T_J = 175^\circ\text{C}$ )	$I_{Dpulse}$	308	A
Maximum Power Dissipation @ $T_C = 80^\circ\text{C}$ ( $T_J = 175^\circ\text{C}$ )	$P_{tot}$	328	W
Minimum Operating Junction Temperature	$T_{JMIN}$	-40	$^\circ\text{C}$
Maximum Operating Junction Temperature	$T_{JMAX}$	175	$^\circ\text{C}$

## THERMAL PROPERTIES

Storage Temperature range	$T_{stg}$	-40 to 150	$^\circ\text{C}$
---------------------------	-----------	------------	------------------

## INSULATION PROPERTIES

Isolation test voltage, $t = 1$ s, 60 Hz	$V_{is}$	4800	$V_{RMS}$
Creepage distance		12.7	mm

Stresses exceeding those listed in the Maximum Ratings table may damage the device. If any of these limits are exceeded, device functionality should not be assumed, damage may occur and reliability may be affected.

1. Refer to ELECTRICAL CHARACTERISTICS, RECOMMENDED OPERATING RANGES and/or APPLICATION INFORMATION for Safe Operating parameters.

## RECOMMENDED OPERATING RANGES

Rating	Symbol	Min	Max	Unit
Module Operating Junction Temperature	$T_J$	-40	150	$^\circ\text{C}$

Functional operation above the stresses listed in the Recommended Operating Ranges is not implied. Extended exposure to stresses beyond the Recommended Operating Ranges limits may affect device reliability.

# NXH010P90MNF1PTG, NXH010P90MNF1PG

## ELECTRICAL CHARACTERISTICS (T<sub>J</sub> = 25°C unless otherwise noted)

Parameter	Test Conditions	Symbol	Min	Typ	Max	Unit	
<b>SIC MOSFET CHARACTERISTICS</b>							
Drain–Source Breakdown Voltage	V <sub>GS</sub> = 0 V, I <sub>D</sub> = 400 μA	V <sub>(BR)DSS</sub>	900	–	–	V	
Zero Gate Voltage Drain Current	V <sub>GS</sub> = 0 V, V <sub>DS</sub> = 900 V	I <sub>DSS</sub>	–	–	200	μA	
Drain–Source On Resistance	V <sub>GS</sub> = 15 V, I <sub>D</sub> = 100 A, T <sub>J</sub> = 25°C	R <sub>DS(ON)</sub>	–	10.03	14	mΩ	
	V <sub>GS</sub> = 15 V, I <sub>D</sub> = 100 A, T <sub>J</sub> = 125°C		–	10.08	–		
	V <sub>GS</sub> = 15 V, I <sub>D</sub> = 100 A, T <sub>J</sub> = 150°C		–	11.61	–		
Gate–Source Threshold Voltage	V <sub>GS</sub> = V <sub>DS</sub> , I <sub>D</sub> = 40 mA	V <sub>GS(TH)</sub>	1.8	2.74	4.3	V	
Gate Leakage Current	V <sub>GS</sub> = –5/15 V, V <sub>DS</sub> = 0 V	I <sub>GSS</sub>	–500	–	500	nA	
Internal Gate Resistance		R <sub>G</sub>		0.8		Ω	
Input Capacitance	V <sub>DS</sub> = 450 V, V <sub>GS</sub> = 0 V, f = 1 MHz	C <sub>ISS</sub>	–	7007	–	pF	
Reverse Transfer Capacitance		C <sub>RSS</sub>	–	44	–		
Output Capacitance		C <sub>OSS</sub>	–	665	–		
C <sub>OSS</sub> Stored Energy	V <sub>DS</sub> = 0 V to 800 V, V <sub>GS</sub> = 0 V	E <sub>OSS</sub>	–	251	–	μJ	
Total Gate Charge	V <sub>DS</sub> = 720 V, V <sub>GS</sub> = –15/15 V, I <sub>D</sub> = 100 A	Q <sub>G(TOTAL)</sub>	–	546.4	–	nC	
Gate–Source Charge		Q <sub>GS</sub>	–	105.45	–	nC	
Gate–Drain Charge		Q <sub>GD</sub>	–	122.7	–	nC	
Turn–on Delay Time	T <sub>J</sub> = 25°C V <sub>DS</sub> = 600 V, I <sub>D</sub> = 100 A V <sub>GS</sub> = –5 V/18 V, R <sub>G</sub> = 1.5 Ω	t <sub>d(on)</sub>	–	53	–	ns	
Rise Time		t <sub>r</sub>	–	16	–		
Turn–off Delay Time		t <sub>d(off)</sub>	–	150	–		
Fall Time		t <sub>f</sub>	–	12	–		
Turn–on Switching Loss per Pulse		E <sub>ON</sub>	–	1.13	–		mJ
Turn off Switching Loss per Pulse		E <sub>OFF</sub>	–	0.65	–		
Turn–on Delay Time	T <sub>J</sub> = 150°C V <sub>DS</sub> = 600 V, I <sub>D</sub> = 100 A V <sub>GS</sub> = –5 V/18 V, R <sub>G</sub> = 1.5 Ω	t <sub>d(on)</sub>	–	50.4	–	ns	
Rise Time		t <sub>r</sub>	–	15.5	–		
Turn–off Delay Time		t <sub>d(off)</sub>	–	165	–		
Fall Time		t <sub>f</sub>	–	13	–		
Turn–on Switching Loss per Pulse		E <sub>ON</sub>	–	1.24	–		mJ
Turn off Switching Loss per Pulse		E <sub>OFF</sub>	–	0.67	–		
Diode Forward Voltage	I <sub>D</sub> = 100 A, T <sub>J</sub> = 25°C	V <sub>SD</sub>	–	4.47	6	V	
	I <sub>D</sub> = 100 A, T <sub>J</sub> = 150°C		–	3.92	–		
Thermal Resistance – Chip–to–Case	M1, M2	R <sub>thJC</sub>	–	0.29	–	°C/W	
Thermal Resistance – Chip–to–Heatsink	Thermal grease, Thickness = 2 Mil _2%, A = 2.8 W/mK	R <sub>thJH</sub>	–	0.46	–	°C/W	

## THERMISTOR CHARACTERISTICS

Nominal resistance	T = 25°C	R <sub>25</sub>	–	5	–	kΩ
Nominal resistance	T = 100°C	R <sub>100</sub>	–	457	–	Ω
Deviation of R25		ΔR/R	–3	–	3	%
Power dissipation		P <sub>D</sub>	–	50	–	mW
Power dissipation constant			–	5	–	mW/K
B–value	B(25/50), tolerance ±3%		–	3375	–	K
B–value	B(25/100), tolerance ±3%		–	3455	–	K

Product parametric performance is indicated in the Electrical Characteristics for the listed test conditions, unless otherwise noted. Product performance may not be indicated by the Electrical Characteristics if operated under different conditions.

# NXH010P90MNF1PTG, NXH010P90MNF1PG

## ORDERING INFORMATION

Orderable Part Number	Marking	Package	Shipping
NXH010P90MNF1PG	NXH010P90MNF1PG	F1-2PACK: Case 180BW Press-fit Pins (Pb - Free and Halide - Free)	28 Units / Blister Tray
NXH010P90MNF1PTG	NXH010P90MNF1PTG	F1-2PACK: Case 180BW Press-fit Pins with pre - applied thermal interface material (TIM) (Pb - Free and Halide - Free)	28 Units / Blister Tray

# NXH010P90MNF1PTG, NXH010P90MNF1PG

## TYPICAL CHARACTERISTICS

SIC MOSFET (M1/M2)

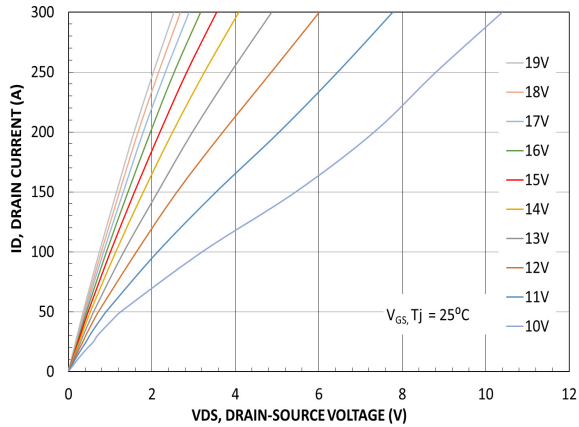

Figure 2. MOSFET Typical Output Characteristics

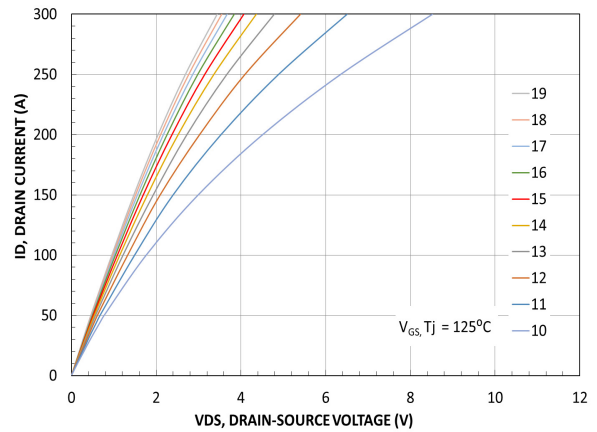

Figure 3. MOSFET Typical Output Characteristics

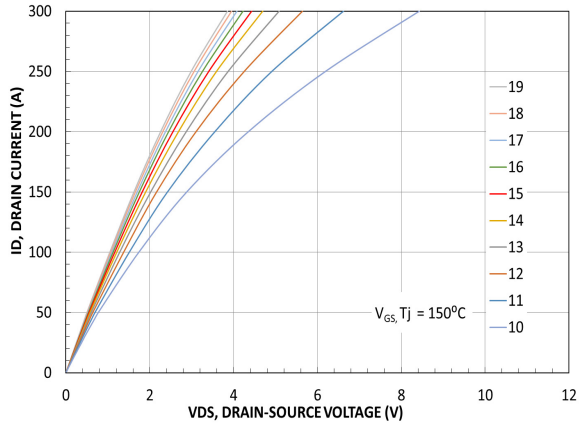

Figure 4. MOSFET Typical Output Characteristics

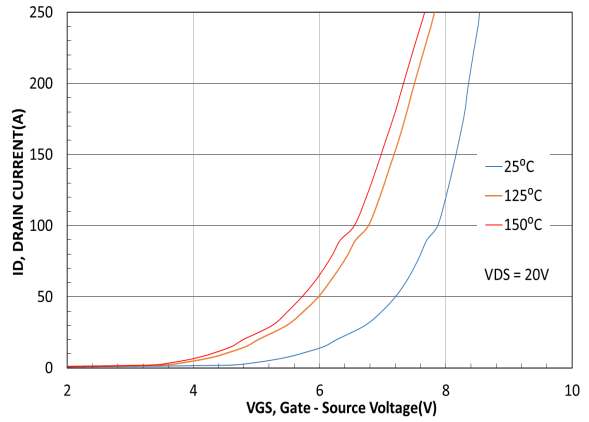

Figure 5. MOSFET Typical Transfer Characteristics

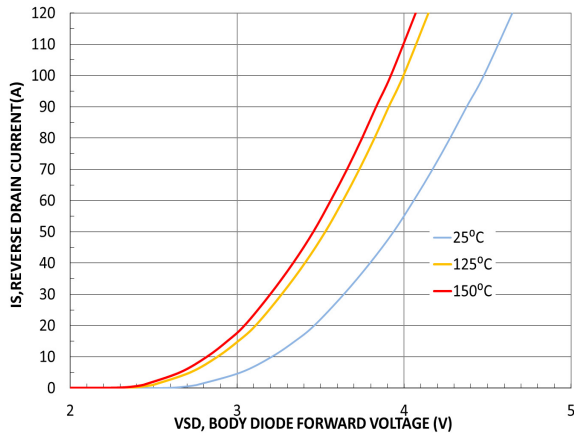

Figure 6. Body Diode Forward Characteristics

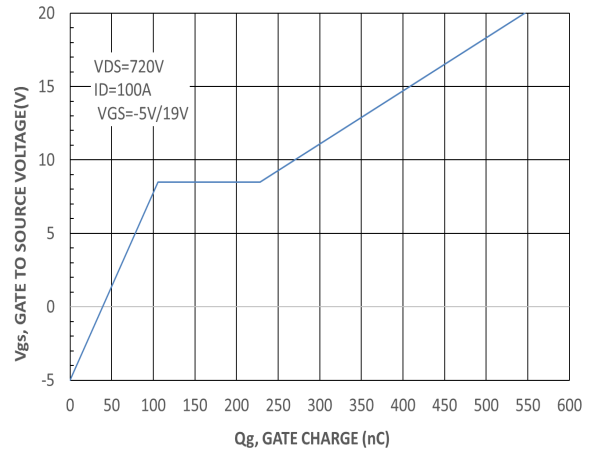

Figure 7. Gate-to-Source Voltage vs. Total Charge

# NXH010P90MNF1PTG, NXH010P90MNF1PG

## TYPICAL CHARACTERISTICS

SIC MOSFET (M1/M2)

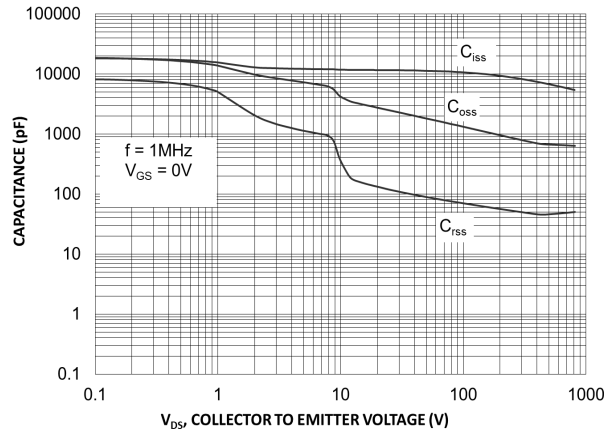

Figure 8. Capacitance vs. Drain-to-Source Voltage

# NXH010P90MNF1PTG, NXH010P90MNF1PG

## TYPICAL CHARACTERISTICS

### M1/M2 MOSFET SWITCHING CHARACTERISTICS

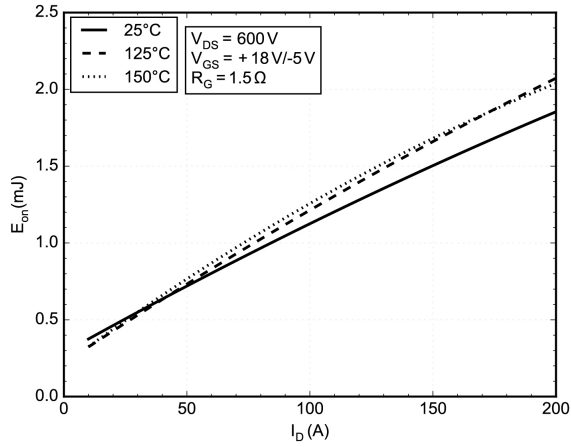

Figure 9. Typical Switching Loss  $E_{on}$  vs.  $I_D$

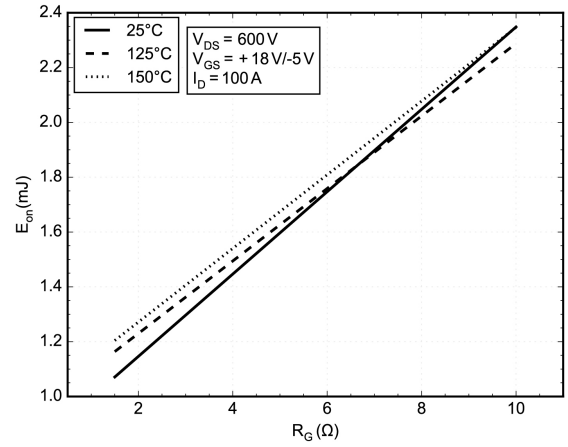

Figure 10. Typical Switching Loss  $E_{on}$  vs.  $R_G$

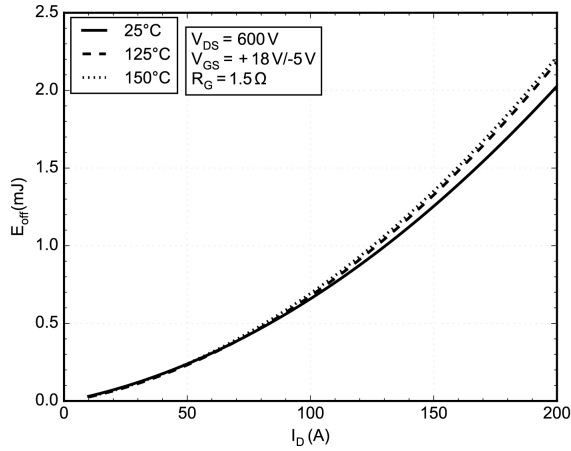

Figure 11. Typical Switching Loss  $E_{off}$  vs.  $I_D$

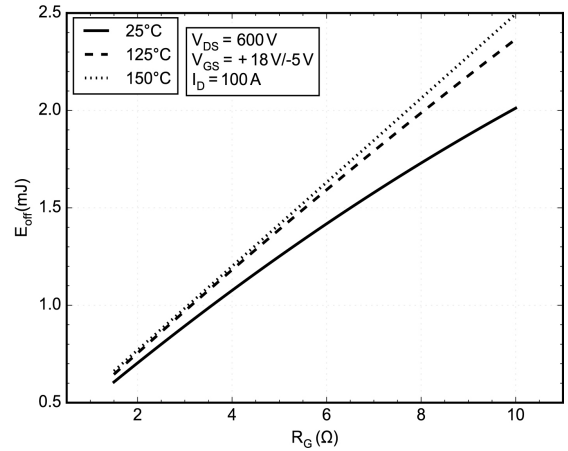

Figure 12. Typical Switching Loss  $E_{off}$  vs.  $R_G$

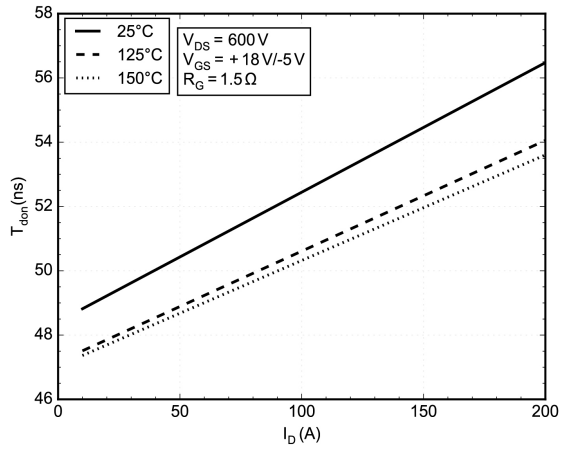

Figure 13. Typical Turn-On Switching  $T_{d(on)}$  vs.  $I_D$

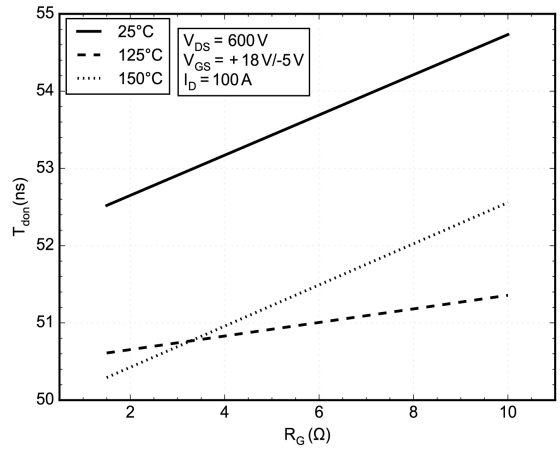

Figure 14. Typical Turn-On Switching  $T_{d(on)}$  vs.  $R_G$

# NXH010P90MNF1PTG, NXH010P90MNF1PG

## TYPICAL CHARACTERISTICS M1/M2 MOSFET SWITCHING CHARACTERISTICS

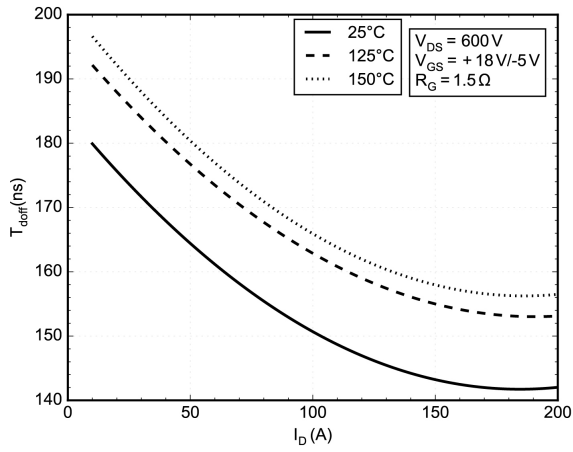

Figure 15. Typical Turn-off Switching  $T_{d(off)}$  vs.  $I_D$

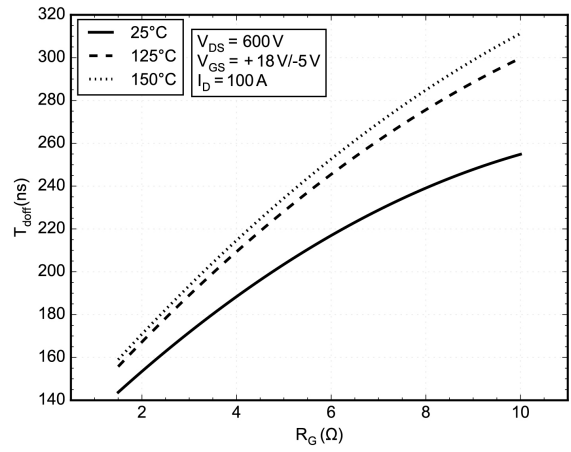

Figure 16. Typical Turn-off Switching  $T_{d(off)}$  vs.  $R_G$

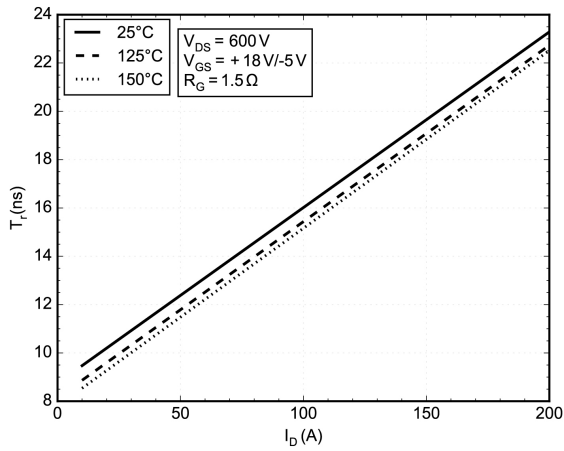

Figure 17. Typical Turn-On Switching  $T_r$  vs.  $I_D$

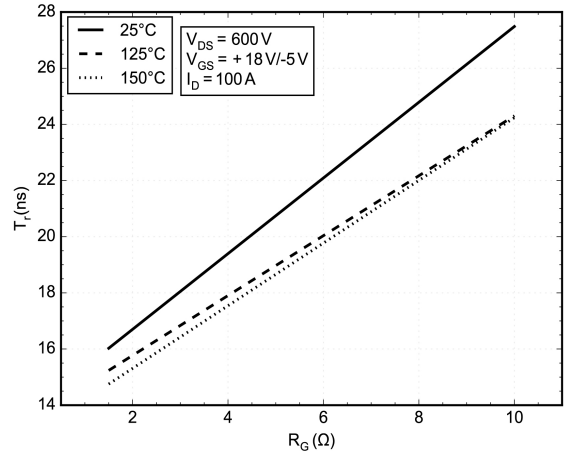

Figure 18. Typical Turn-On Switching  $T_r$  vs.  $R_G$

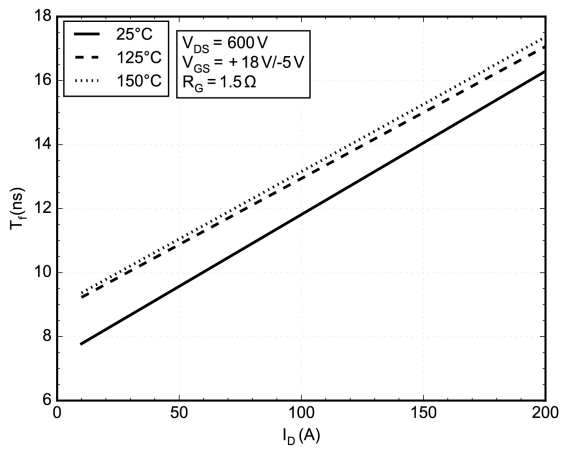

Figure 19. Typical Turn-Off Switching  $T_f$  vs.  $I_D$

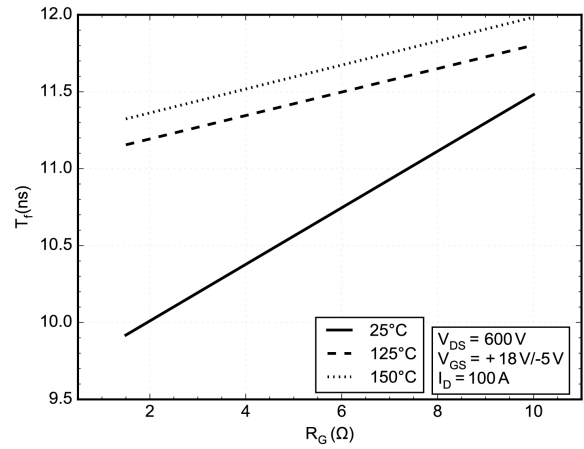

Figure 20. Typical Turn-Off Switching  $T_f$  vs.  $R_G$



# NXH010P90MNF1PTG, NXH010P90MNF1PG

## TYPICAL CHARACTERISTICS

### M1/M2 MOSFET SWITCHING CHARACTERISTICS

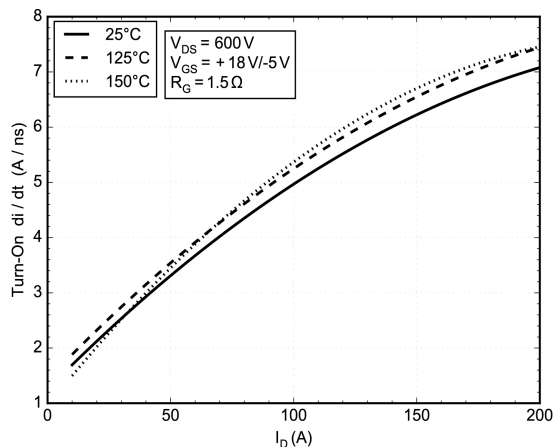

Figure 21. di/dt ON vs  $I_D$

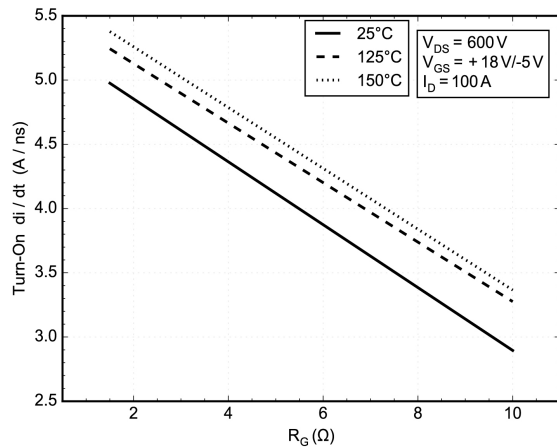

Figure 22. di/dt ON vs.  $R_G$

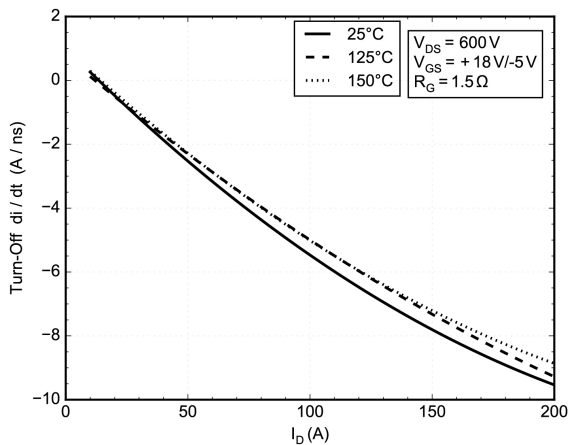

Figure 23. di/dt OFF vs  $I_D$

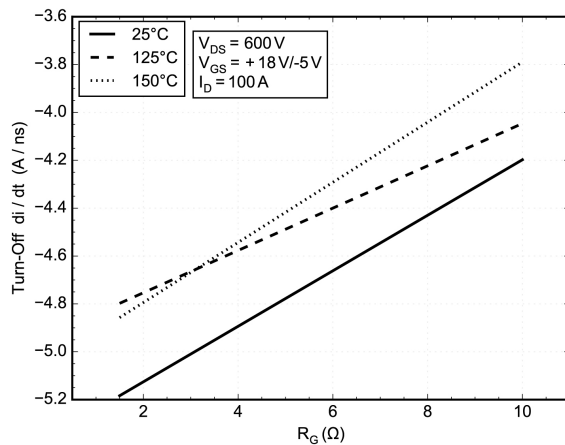

Figure 24. di/dt OFF vs.  $R_G$

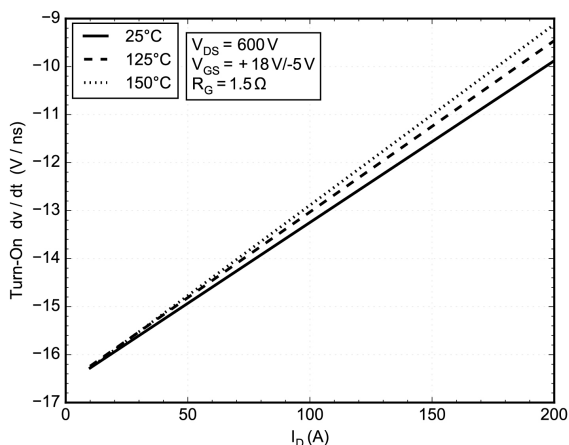

Figure 25. dv/dt ON vs  $I_D$

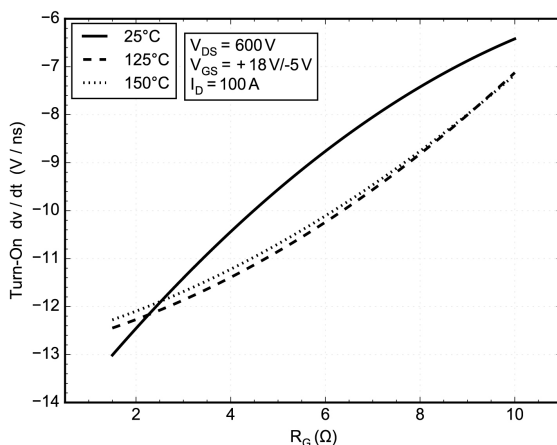

Figure 26. dv/dt ON vs.  $R_G$

NXH010P90MNF1PTG, NXH010P90MNF1PG

TYPICAL CHARACTERISTICS  
M1/M2 MOSFET SWITCHING CHARACTERISTICS

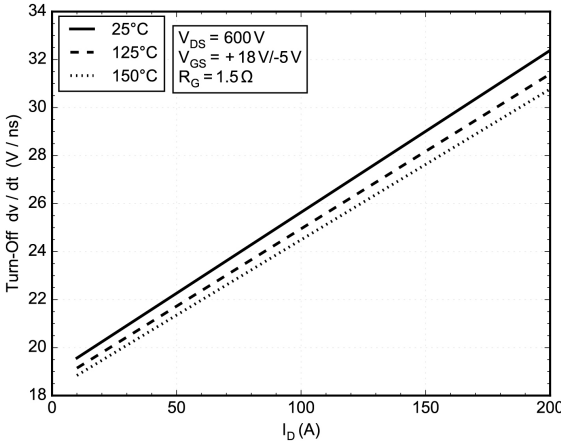

Figure 27. dv/dt OFF vs I<sub>D</sub>

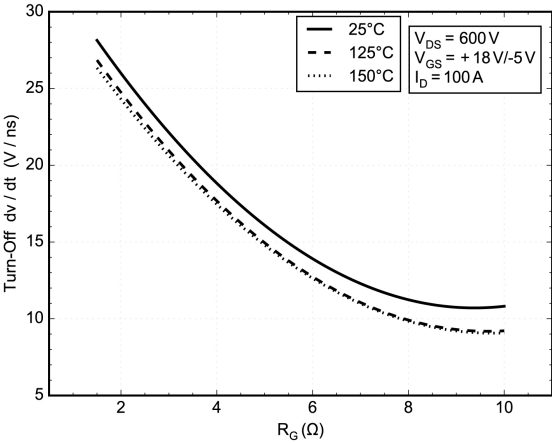

Figure 28. dv/dt OFF vs. R<sub>G</sub>

# NXH010P90MNF1PTG, NXH010P90MNF1PG

## TYPICAL CHARACTERISTICS

SiC MOSFET (M1/M2)

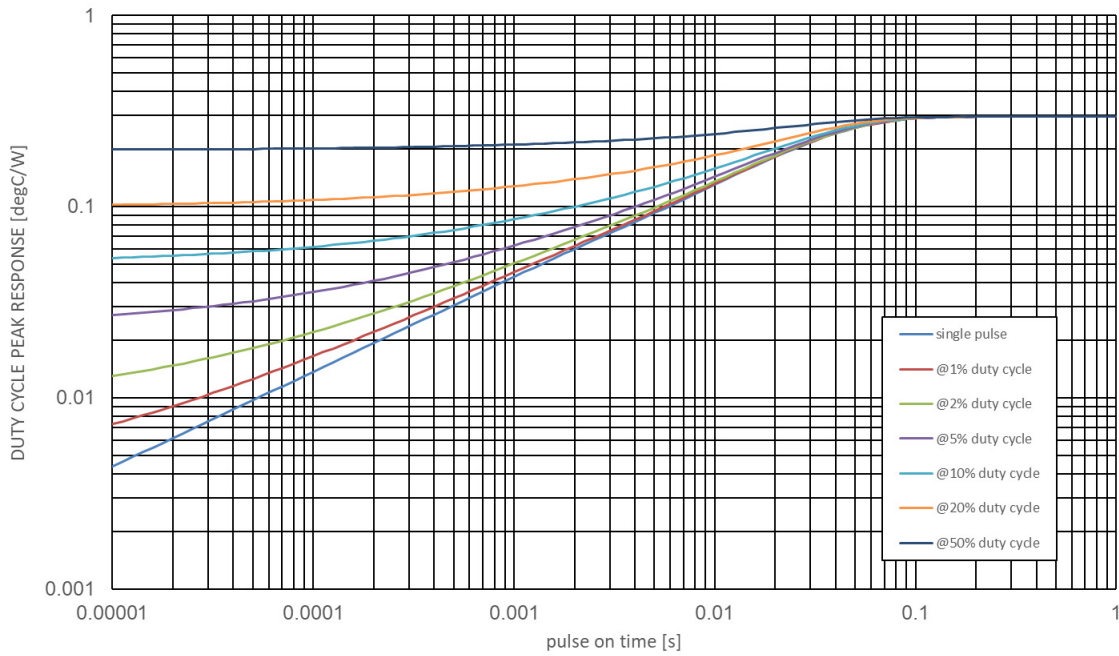

Figure 29. SiC MOSFET Junction-to-Case Transient Thermal Impedance

Table 1. FOSTER NETWORKS – M1, M2

Foster Element #	M1		M2	
	Rth (K/W)	Cth (Ws/K)	Rth (K/W)	Cth (Ws/K)
1	0.018018	0.006761	0.017423	0.006288
2	0.00725	0.110732	0.008856	0.083472
3	0.007012	0.219934	0.007085	0.218085
4	0.034121	0.121787	0.035241	0.119517
5	0.227927	0.132429	0.233897	0.129036

Table 2. CAUER NETWORKS – M1, M2

Cauer Element #	M1		M2	
	Rth (K/W)	Cth (Ws/K)	Rth (K/W)	Cth (Ws/K)
1	0.025529	0.005642	0.026977	0.005357
2	0.050904	0.03348	0.070046	0.034112
3	0.066724	0.042125	0.094049	0.071939
4	0.058571	0.063408	0.040991	0.068148
5	0.092598	0.079724	0.064984	0.039596

# MECHANICAL CASE OUTLINE

## PACKAGE DIMENSIONS

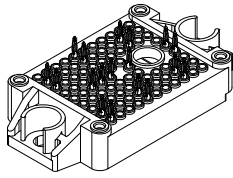

### PIM18 33.8x42.5 (PRESS FIT)

#### CASE 180BW

#### ISSUE B

DATE 30 APR 2021

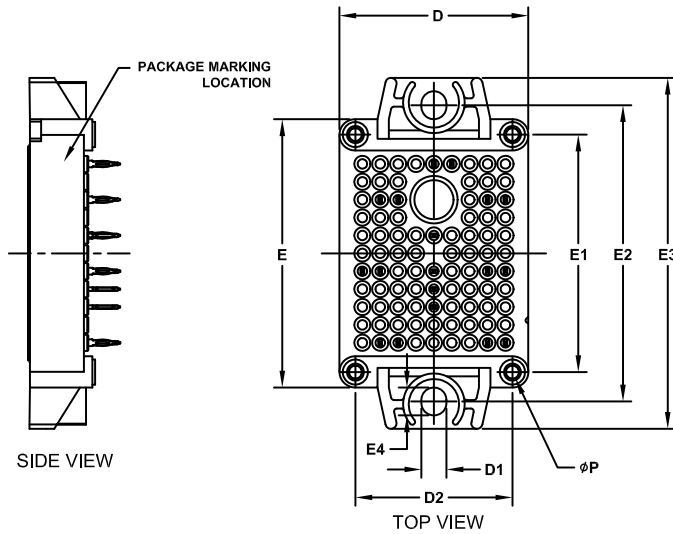

**NOTES:**

1. CONTROLLING DIMENSION: MILLIMETERS
2. PIN POSITION TOLERANCE IS  $\pm 0.4\text{mm}$

DIM	MILLIMETERS		
	MIN.	NOM.	MAX.
A	11.65	12.00	12.35
A1	16.00	16.50	17.00
A2	0.00	0.35	0.60
A3	12.85	13.35	13.85
b	1.15	1.20	1.25
b1	0.59	0.64	0.69
D	33.50	33.80	34.10
D1	4.40	4.50	4.60
D2	27.95	28.10	28.25
E	47.70	48.00	48.30
E1	42.35	42.50	42.65
E2	52.90	53.00	53.10
E3	62.30	62.80	63.30
E4	4.90	5.00	5.10
P	2.20	2.30	2.40

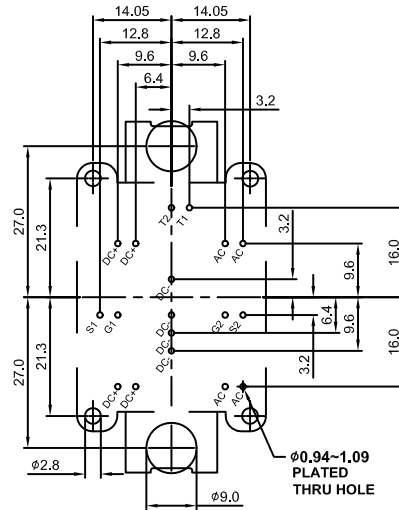
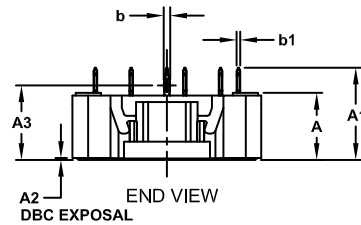

### GENERIC MARKING DIAGRAM\*

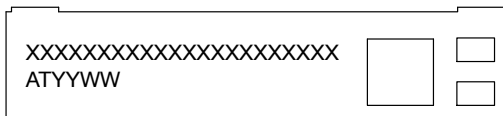

XXXXX = Specific Device Code  
 AT = Assembly & Test Site Code  
 YYWW = Year and Work Week Code

\*This information is generic. Please refer to device data sheet for actual part marking. Pb-Free indicator, "G" or microdot "\*", may or may not be present. Some products may not follow the Generic Marking.

<b>DOCUMENT NUMBER:</b>	<b>98AON19723H</b>	Electronic versions are uncontrolled except when accessed directly from the Document Repository. Printed versions are uncontrolled except when stamped "CONTROLLED COPY" in red.
<b>DESCRIPTION:</b>	<b>PIM18 33.8x42.5 (PRESS FIT)</b>	<b>PAGE 1 OF 1</b>

onsemi and ONSEMI are trademarks of Semiconductor Components Industries, LLC dba onsemi or its subsidiaries in the United States and/or other countries. onsemi reserves the right to make changes without further notice to any products herein. onsemi makes no warranty, representation or guarantee regarding the suitability of its products for any particular purpose, nor does onsemi assume any liability arising out of the application or use of any product or circuit, and specifically disclaims any and all liability, including without limitation special, consequential or incidental damages. onsemi does not convey any license under its patent rights nor the rights of others.

**onsemi**, **Onsemi**, and other names, marks, and brands are registered and/or common law trademarks of Semiconductor Components Industries, LLC dba "**onsemi**" or its affiliates and/or subsidiaries in the United States and/or other countries. **onsemi** owns the rights to a number of patents, trademarks, copyrights, trade secrets, and other intellectual property. A listing of **onsemi**'s product/patent coverage may be accessed at [www.onsemi.com/site/pdf/Patent-Marking.pdf](http://www.onsemi.com/site/pdf/Patent-Marking.pdf). **onsemi** reserves the right to make changes at any time to any products or information herein, without notice. The information herein is provided "as-is" and **onsemi** makes no warranty, representation or guarantee regarding the accuracy of the information, product features, availability, functionality, or suitability of its products for any particular purpose, nor does **onsemi** assume any liability arising out of the application or use of any product or circuit, and specifically disclaims any and all liability, including without limitation special, consequential or incidental damages. Buyer is responsible for its products and applications using **onsemi** products, including compliance with all laws, regulations and safety requirements or standards, regardless of any support or applications information provided by **onsemi**. "Typical" parameters which may be provided in **onsemi** data sheets and/or specifications can and do vary in different applications and actual performance may vary over time. All operating parameters, including "Typicals" must be validated for each customer application by customer's technical experts. **onsemi** does not convey any license under any of its intellectual property rights nor the rights of others. **onsemi** products are not designed, intended, or authorized for use as a critical component in life support systems or any FDA Class 3 medical devices or medical devices with a same or similar classification in a foreign jurisdiction or any devices intended for implantation in the human body. Should Buyer purchase or use **onsemi** products for any such unintended or unauthorized application, Buyer shall indemnify and hold **onsemi** and its officers, employees, subsidiaries, affiliates, and distributors harmless against all claims, costs, damages, and expenses, and reasonable attorney fees arising out of, directly or indirectly, any claim of personal injury or death associated with such unintended or unauthorized use, even if such claim alleges that **onsemi** was negligent regarding the design or manufacture of the part. **onsemi** is an Equal Opportunity/Affirmative Action Employer. This literature is subject to all applicable copyright laws and is not for resale in any manner.

## PUBLICATION ORDERING INFORMATION

### LITERATURE FULFILLMENT:

Email Requests to: [orderlit@onsemi.com](mailto:orderlit@onsemi.com)

**onsemi Website:** [www.onsemi.com](http://www.onsemi.com)

### TECHNICAL SUPPORT

**North American Technical Support:**

Voice Mail: 1 800-282-9855 Toll Free USA/Canada

Phone: 011 421 33 790 2910

**Europe, Middle East and Africa Technical Support:**

Phone: 00421 33 790 2910

For additional information, please contact your local Sales Representative