

Inverter Grade Thyristors (Hockey PUK Version), 940 A



B-PUK (TO-200AC)



**RoHS
COMPLIANT**

FEATURES

- Metal case with ceramic insulator
- All diffused design
- Center amplifying gate
- Guaranteed high dV/dt
- Guaranteed high dI/dt
- International standard case B-PUK (TO-200AC)
- High surge current capability
- Low thermal impedance
- High speed performance
- Designed and qualified for industrial level
- Material categorization: for definitions of compliance please see www.vishay.com/doc?99912

TYPICAL APPLICATIONS

- Inverters
- Choppers
- Induction heating
- All types of force-commutated converters

PRIMARY CHARACTERISTICS	
Package	B-PUK (TO-200AC)
Circuit configuration	Single SCR
$I_{T(AV)}$	940 A
V_{DRM}/V_{RRM}	400 V, 800 V
V_{TM}	1.63 V
I_{TSM} at 50 Hz	20 000 A
I_{TSM} at 60 Hz	20 950 A
I_{GT}	200 mA
T_C/T_{hs}	55 °C

MAJOR RATINGS AND CHARACTERISTICS			
PARAMETER	TEST CONDITIONS	VALUES	UNITS
$I_{T(AV)}$		940	A
	T_{hs}	55	°C
$I_{T(RMS)}$		1900	A
	T_{hs}	25	°C
I_{TSM}	50 Hz	20 000	A
	60 Hz	20 950	
I^2t	50 Hz	2000	kA ² s
	60 Hz	1820	
V_{DRM}/V_{RRM}		400 to 800	V
t_q	Range	10 to 20	µs
T_J		-40 to +125	°C

ELECTRICAL SPECIFICATIONS

VOLTAGE RATINGS				
TYPE NUMBER	VOLTAGE CODE	V_{DRM}/V_{RRM} , MAXIMUM REPETITIVE PEAK VOLTAGE V	V_{RSM} , MAXIMUM NON-REPETITIVE PEAK VOLTAGE V	I_{DRM}/I_{RRM} MAXIMUM AT $T_J = T_J$ MAXIMUM mA
VS-ST733C..L	04	400	500	75
	08	800	900	



CURRENT CARRYING CAPABILITY							
FREQUENCY							UNITS
50 Hz	2200	1900	3580	3100	6800	5920	A
400 Hz	2050	1660	3600	3130	3750	3240	
1000 Hz	1370	1070	2900	2450	2120	1780	
2500 Hz	500	370	1220	980	960	770	
Recovery voltage V_R	50		50		50		V
Voltage before turn-on V_D	V_{DRM}		V_{DRM}		V_{DRM}		
Rise of on-state current di/dt	50		-		-		A/ μ s
Heatsink temperature	40	55	40	55	40	55	$^{\circ}$ C
Equivalent values for RC circuit	10/0.47		10/0.47		10/0.47		Ω/μ F

ABSOLUTE MAXIMUM RATINGS						
PARAMETER	SYMBOL	TEST CONDITIONS		VALUES	UNITS	
Maximum average on-state current at heatsink temperature	$I_{T(AV)}$	180 $^{\circ}$ conduction, half sine wave double side (single side) cooled		940 (350)	A	
				55 (85)	$^{\circ}$ C	
Maximum RMS on-state current	$I_{T(RMS)}$	DC at 25 $^{\circ}$ C heatsink temperature double side cooled		1900		
Maximum peak, one half cycle, non-repetitive surge current	I_{TSM}	t = 10 ms	No voltage reapplied	Sinusoidal half wave, initial $T_J = T_J$ maximum	20 000	A
		t = 8.3 ms			20 950	
		t = 10 ms	100 % V_{RRM} reapplied		16 800	
		t = 8.3 ms			17 600	
Maximum I^2t for fusing	I^2t	t = 10 ms	No voltage reapplied		2000	kA 2 s
		t = 8.3 ms			1820	
		t = 10 ms	100 % V_{RRM} reapplied		1410	
		t = 8.3 ms			1290	
Maximum $I^2\sqrt{t}$ for fusing	$I^2\sqrt{t}$	t = 0.1 ms to 10 ms, no voltage reapplied		20 000	kA $^2\sqrt{s}$	
Maximum peak on-state voltage	V_{TM}	$I_{TM} = 1700$ A, $T_J = T_J$ maximum, $t_p = 10$ ms sine wave pulse		1.63	V	
Low level value of threshold voltage	$V_{T(TO)1}$	$(16.7 \% \times \pi \times I_{T(AV)}) < I < \pi \times I_{T(AV)}$, $T_J = T_J$ maximum		1.09		
High level value of threshold voltage	$V_{T(TO)2}$	$I > \pi \times I_{T(AV)}$, $T_J = T_J$ maximum		1.20		
Low level value of forward slope resistance	r_{t1}	$(16.7 \% \times \pi \times I_{T(AV)}) < I < \pi \times I_{T(AV)}$, $T_J = T_J$ maximum		0.32	m Ω	
High level value of forward slope resistance	r_{t2}	$I > \pi \times I_{T(AV)}$, $T_J = T_J$ maximum		0.29		
Maximum holding current	I_H	$T_J = 25$ $^{\circ}$ C, $I_T > 30$ A		600	mA	
Typical latching current	I_L	$T_J = 25$ $^{\circ}$ C, $V_A = 12$ V, $R_a = 6$ Ω , $I_G = 1$ A		1000		

SWITCHING					
PARAMETER	SYMBOL	TEST CONDITIONS		VALUES	UNITS
Maximum non-repetitive rate of rise of turned-on current	di/dt	$T_J = T_J$ maximum, $V_{DRM} =$ Rated V_{DRM} , $I_{TM} = 2 \times di/dt$ Gate pulse: 20 V 20 Ω , 10 μ s 0.5 μ s rise time		1000	A/ μ s
Typical delay time	t_d	$T_J = 25$ $^{\circ}$ C, $V_{DM} =$ Rated V_{DRM} , $I_{TM} = 50$ A DC, $t_p = 1$ μ s Resistive load, gate pulse: 10 V, 5 Ω source		1.5	μ s
Maximum turn-off time	minimum	t_q	$T_J = T_J$ maximum, $I_{TM} = 550$ A, commutating $di/dt = 40$ A/ μ s, $V_R = 50$ V, $t_p = 500$ μ s, dV/dt : see table in device code	10	
	maximum			20	



BLOCKING				
PARAMETER	SYMBOL	TEST CONDITIONS	VALUES	UNITS
Maximum critical rate of rise of off-state voltage	dV/dt	T _J = T _J maximum, linear to 80 % V _{DRM} , higher value available on request	500	V/μs
Maximum peak reverse and off-state leakage current	I _{RRM} , I _{DRM}	T _J = T _J maximum, rated V _{DRM} /V _{RRM} applied	75	mA

TRIGGERING				
PARAMETER	SYMBOL	TEST CONDITIONS	VALUES	UNITS
Maximum peak gate power	P _{GM}	T _J = T _J maximum, f = 50 Hz, d% = 50	60	W
Maximum average gate power	P _{G(AV)}		10	
Maximum peak positive gate current	I _{GM}	T _J = T _J maximum, t _p ≤ 5 ms	10	A
Maximum peak positive gate voltage	+V _{GM}		20	V
Maximum peak negative gate voltage	-V _{GM}		5	
Maximum DC gate current required to trigger	I _{GT}		T _J = 25 °C, V _A = 12 V, R _a = 6 Ω	200
Maximum DC gate voltage required to trigger	V _{GT}	3		V
Maximum DC gate current not to trigger	I _{GD}	T _J = T _J maximum, rated V _{DRM} applied	20	mA
Maximum DC gate voltage not to trigger	V _{GD}		0.25	V

THERMAL AND MECHANICAL SPECIFICATIONS				
PARAMETER	SYMBOL	TEST CONDITIONS	VALUES	UNITS
Maximum operating junction temperature range	T _J		-40 to +125	°C
Maximum storage temperature range	T _{Stg}		-40 to +150	
Maximum thermal resistance, junction to heatsink	R _{thJ-hs}	DC operation single side cooled	0.073	K/W
		DC operation double side cooled	0.031	
Maximum thermal resistance, case to heatsink	R _{thC-hs}	DC operation single side cooled	0.011	
		DC operation double side cooled	0.005	
Mounting force, ± 10 %			14 700 (1500)	N (kg)
Approximate weight			255	g
Case style		See dimensions - link at the end of datasheet	B-PUK (TO-200AC)	

ΔR_{thJ-hs} CONDUCTION						
CONDUCTION ANGLE	SINUSOIDAL CONDUCTION		RECTANGULAR CONDUCTION		TEST CONDITIONS	UNITS
	SINGLE SIDE	DOUBLE SIDE	SINGLE SIDE	DOUBLE SIDE		
180°	0.009	0.009	0.006	0.006	T _J = T _J maximum	K/W
120°	0.011	0.011	0.011	0.011		
90°	0.014	0.014	0.015	0.015		
60°	0.020	0.021	0.021	0.022		
30°	0.036	0.036	0.036	0.036		

Note

- The table above shows the increment of thermal resistance R_{thJ-hs} when devices operate at different conduction angles than DC

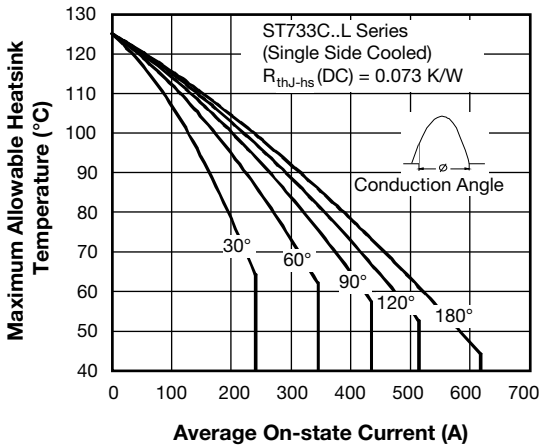

Fig. 1 - Current Ratings Characteristics

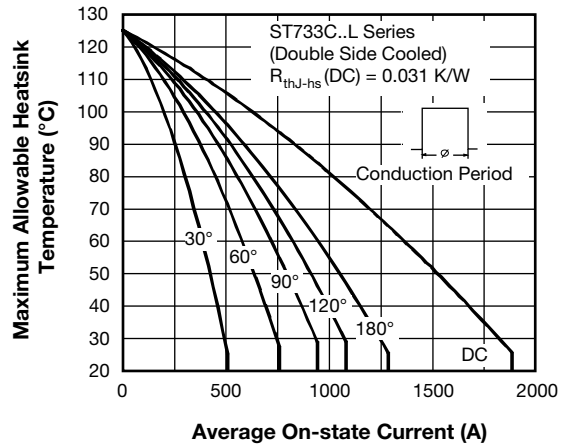

Fig. 4 - Current Ratings Characteristics

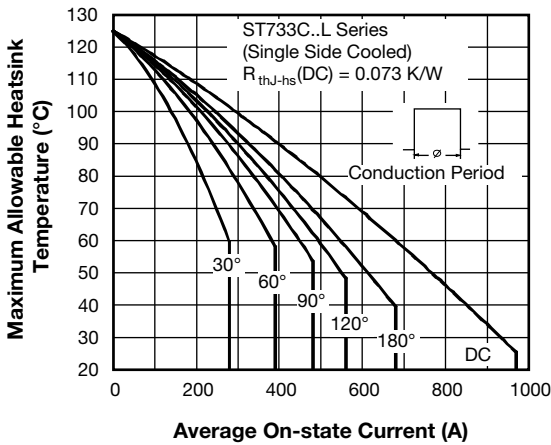

Fig. 2 - Current Ratings Characteristics

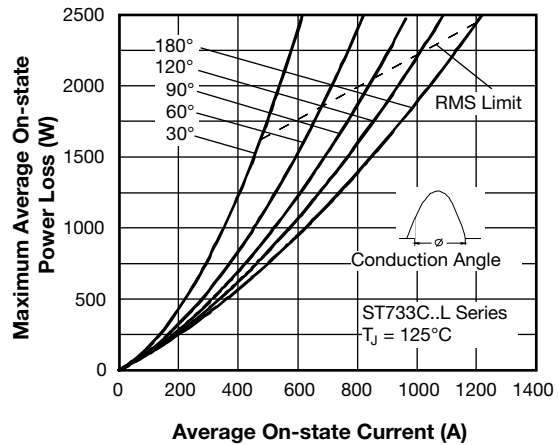

Fig. 5 - On-State Power Loss Characteristics

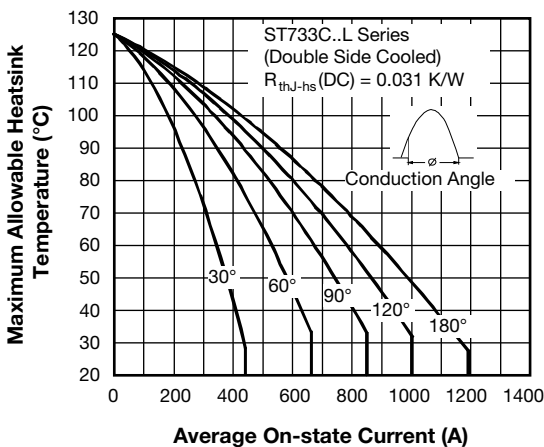

Fig. 3 - Current Ratings Characteristics

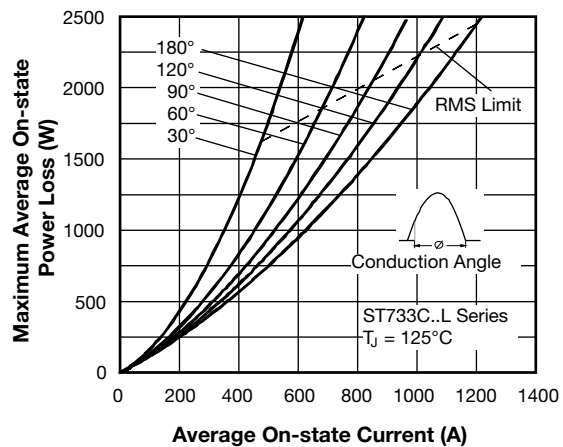

Fig. 6 - On-State Power Loss Characteristics

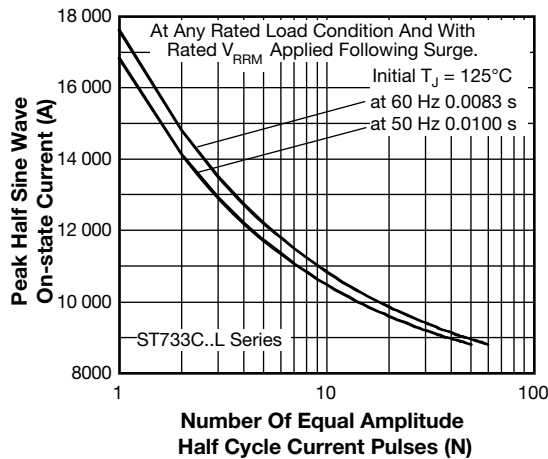

Fig. 7 - Maximum Non-Repetitive Surge Current Single and Double Side Cooled

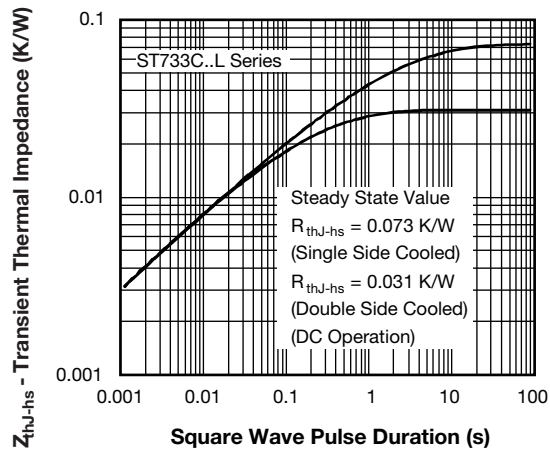

Fig. 10 - Thermal Impedance Z_{thJC} Characteristics

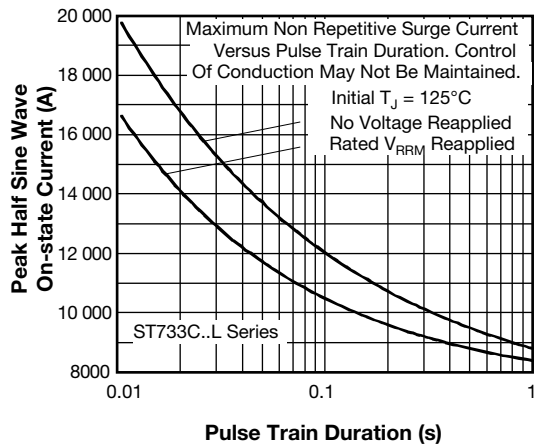

Fig. 8 - Maximum Non-Repetitive Surge Current Single and Double Side Cooled

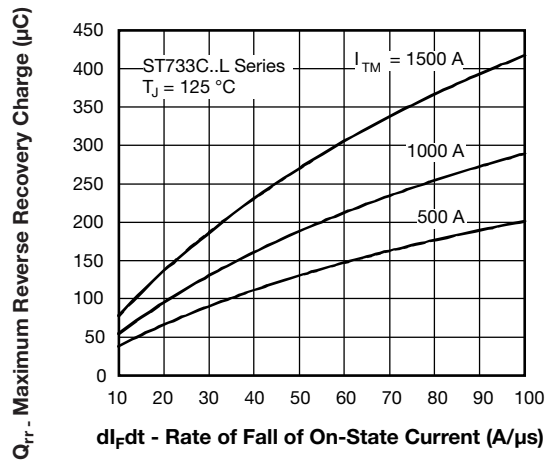

Fig. 11 - Reverse Recovered Charge Characteristics

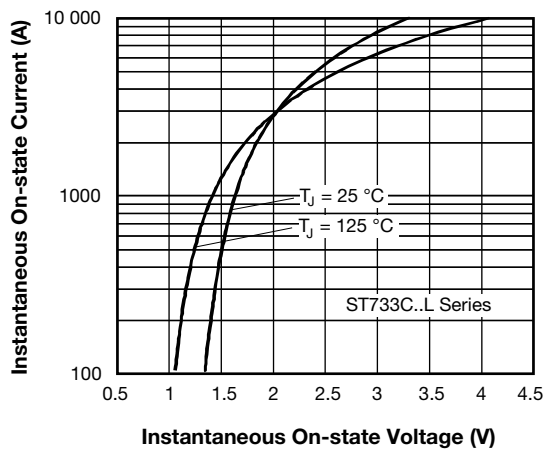

Fig. 9 - On-State Voltage Drop Characteristics

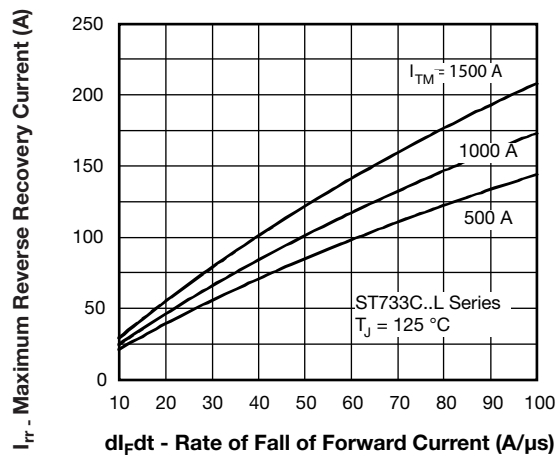

Fig. 12 - Reverse Recovered Current Characteristics

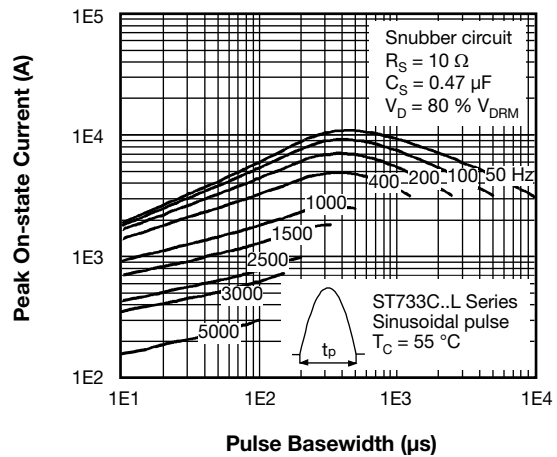
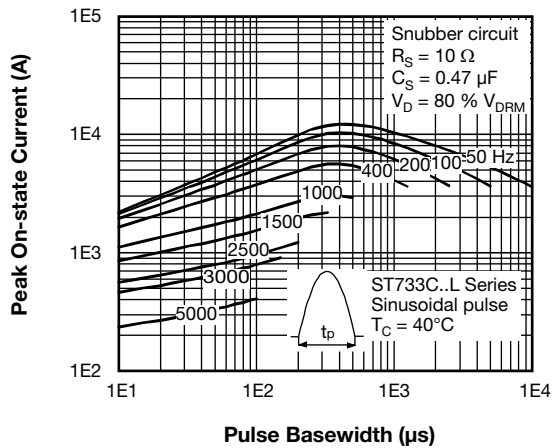

Fig. 13 - Frequency Characteristics

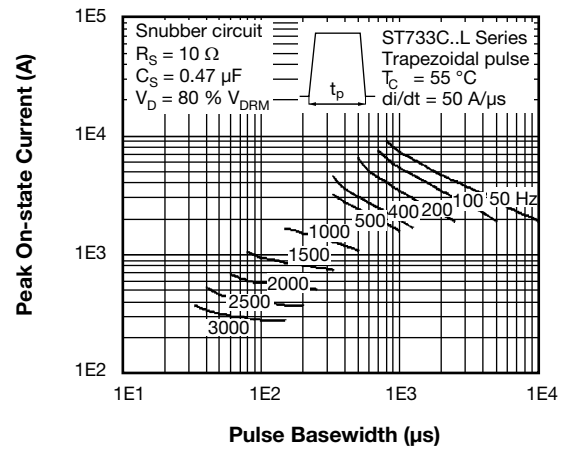
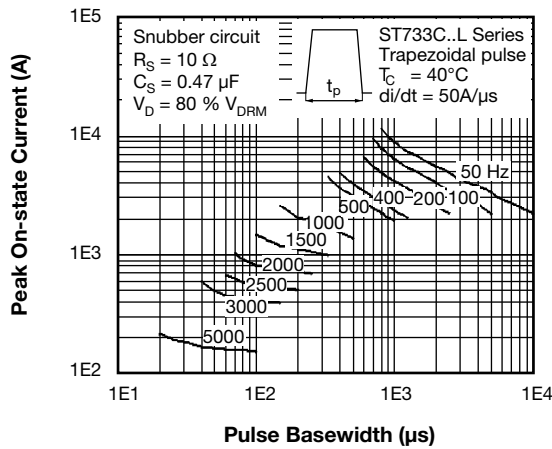

Fig. 14 - Frequency Characteristics

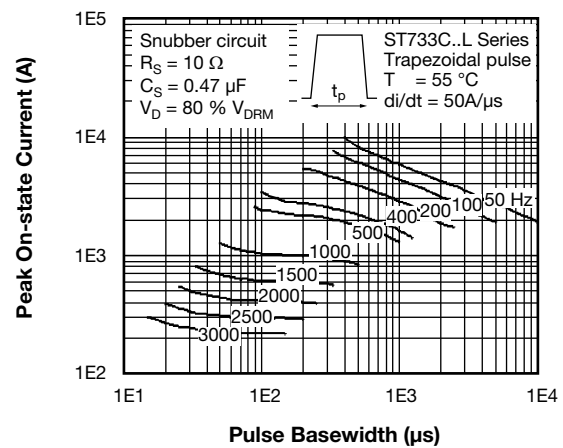
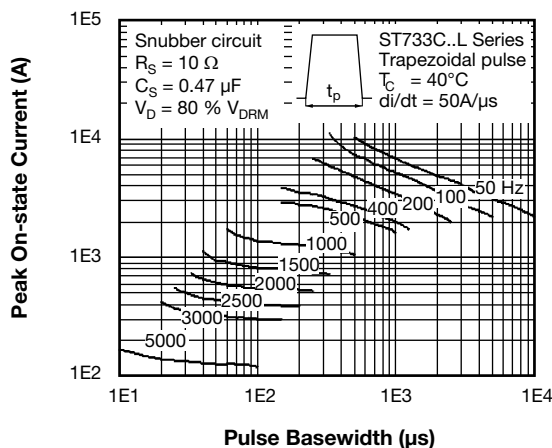

Fig. 15 - Frequency Characteristics

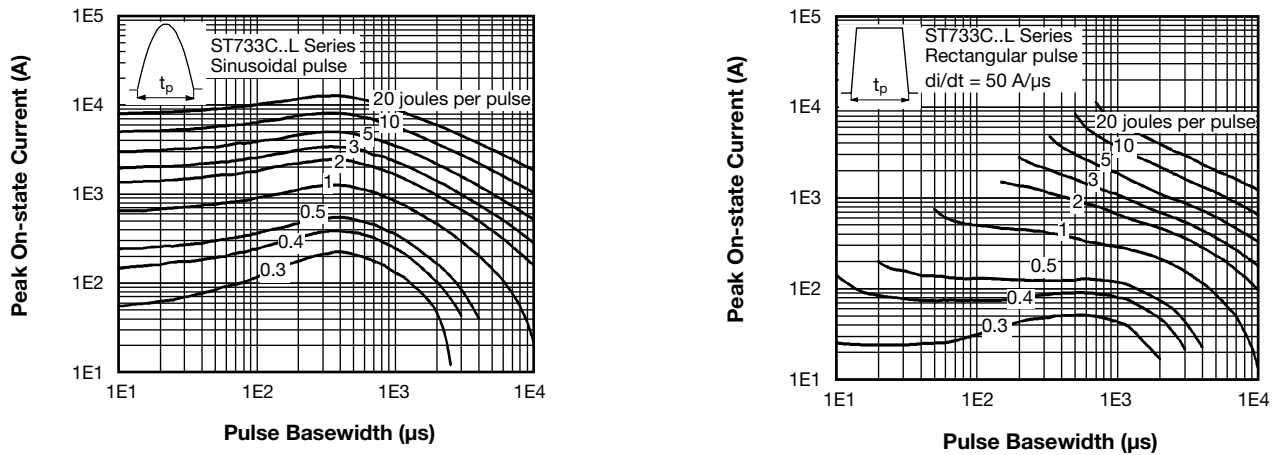

Fig. 16 - Maximum On-State Energy Power Loss Characteristics

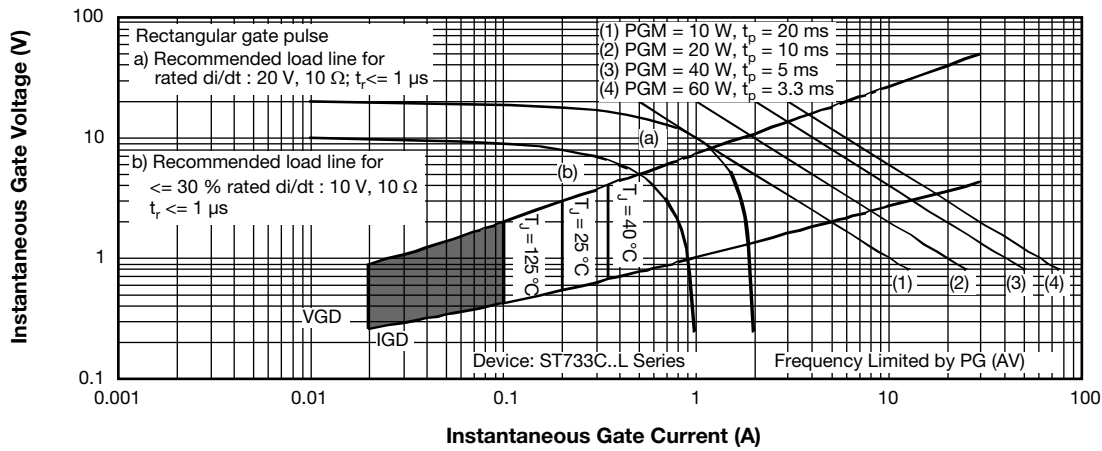

Fig. 17 - Gate Characteristics



ORDERING INFORMATION TABLE

Device code	VS-	ST	73	3	C	08	L	H	K	1	-
	①	②	③	④	⑤	⑥	⑦	⑧	⑨	⑩	⑪

- 1** - Vishay Semiconductors product
- 2** - Thyristor
- 3** - Essential part number
- 4** - 3 = fast turn-off
- 5** - C = ceramic PUK
- 6** - Voltage code x 100 = V_{RRM}
(see Voltage Ratings table)
- 7** - L = PUK case B-PUK (TO-200AC)
- 8** - Reapplied dV/dt code (for t_q test condition)
- 9** - t_q code _____
- 10** - 0 = eyelet terminals
(gate and auxiliary cathode unsoldered leads)
1 = fast-on terminals
(gate and auxiliary cathode unsoldered leads)
2 = eyelet terminals
(gate and auxiliary cathode soldered leads)
3 = fast-on terminals
(gate and auxiliary cathode soldered leads)
- 11** - Critical dV/dt:
 - None = 500 V/ μ s (standard value)
 - L = 1000 V/ μ s (special selection)

dV/dt - t_q combinations available						
	dV/dt (V/ μ s)	20	50	100	200	400
t_q (μ s)	10	CN	DN	EN	-	-
	12	CM	DM	EM	FM*	-
	15	CL	DL	EL	FL*	HL
	18	CP	DP	EP	FP	HP
	20	CK	DK	EK	FK	H

* Standard part number.
All other types available only on request.

LINKS TO RELATED DOCUMENTS	
Dimensions	www.vishay.com/doc?95076



B-PUK (TO-200AC)

DIMENSIONS in millimeters (inches)

Creepage distance: 36.33 (1.430) minimum
Strike distance: 17.43 (0.686) minimum

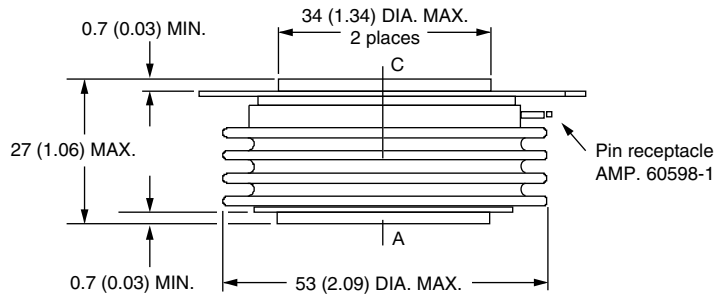

Note:
A = Anode
C = Cathode

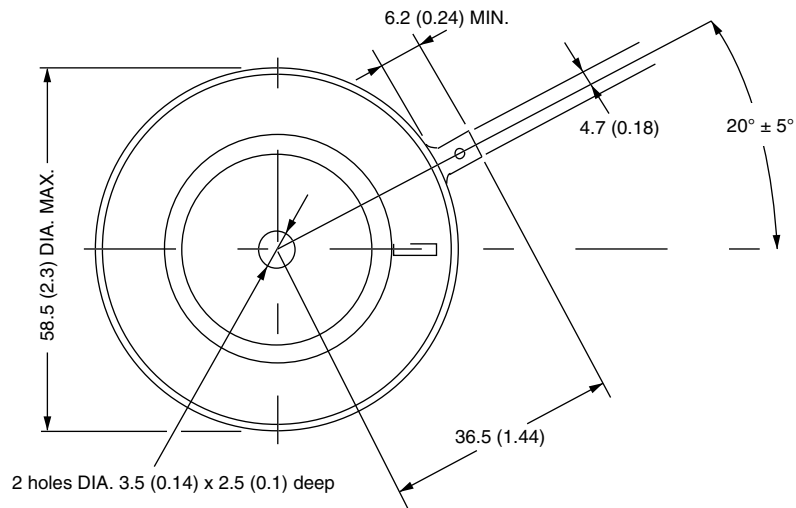

Quote between upper and lower pole pieces has to be considered after application of mounting force (see thermal and mechanical specification)



Disclaimer

ALL PRODUCT, PRODUCT SPECIFICATIONS AND DATA ARE SUBJECT TO CHANGE WITHOUT NOTICE TO IMPROVE RELIABILITY, FUNCTION OR DESIGN OR OTHERWISE.

Vishay Intertechnology, Inc., its affiliates, agents, and employees, and all persons acting on its or their behalf (collectively, "Vishay"), disclaim any and all liability for any errors, inaccuracies or incompleteness contained in any datasheet or in any other disclosure relating to any product.

Vishay makes no warranty, representation or guarantee regarding the suitability of the products for any particular purpose or the continuing production of any product. To the maximum extent permitted by applicable law, Vishay disclaims (i) any and all liability arising out of the application or use of any product, (ii) any and all liability, including without limitation special, consequential or incidental damages, and (iii) any and all implied warranties, including warranties of fitness for particular purpose, non-infringement and merchantability.

Statements regarding the suitability of products for certain types of applications are based on Vishay's knowledge of typical requirements that are often placed on Vishay products in generic applications. Such statements are not binding statements about the suitability of products for a particular application. It is the customer's responsibility to validate that a particular product with the properties described in the product specification is suitable for use in a particular application. Parameters provided in datasheets and / or specifications may vary in different applications and performance may vary over time. All operating parameters, including typical parameters, must be validated for each customer application by the customer's technical experts. Product specifications do not expand or otherwise modify Vishay's terms and conditions of purchase, including but not limited to the warranty expressed therein.

Hyperlinks included in this datasheet may direct users to third-party websites. These links are provided as a convenience and for informational purposes only. Inclusion of these hyperlinks does not constitute an endorsement or an approval by Vishay of any of the products, services or opinions of the corporation, organization or individual associated with the third-party website. Vishay disclaims any and all liability and bears no responsibility for the accuracy, legality or content of the third-party website or for that of subsequent links.

Except as expressly indicated in writing, Vishay products are not designed for use in medical, life-saving, or life-sustaining applications or for any other application in which the failure of the Vishay product could result in personal injury or death. Customers using or selling Vishay products not expressly indicated for use in such applications do so at their own risk. Please contact authorized Vishay personnel to obtain written terms and conditions regarding products designed for such applications.

No license, express or implied, by estoppel or otherwise, to any intellectual property rights is granted by this document or by any conduct of Vishay. Product names and markings noted herein may be trademarks of their respective owners.