

DESCRIPTION

The MP2155 is a highly efficient, low quiescent current Buck-Boost converter, which operates from input voltage above, below and equal to the output voltage. The device provides power solution for products powered by a one-cell Lithium-Ion or multi-cell alkaline battery applications where the output voltage is within battery voltage range.

The MP2155 uses a current mode, fixed frequency PWM control for optimal stability and transient response. The fixed 1MHz switching frequency and integrated low $R_{DS(ON)}$ N-channel and P-channel MOSFETs minimize the solution footprint while maintaining high efficiency.

To ensure the longest battery life MP2155 has an optional pulse skipping mode that reduces switching frequency under light load conditions. For other low noise applications where variable frequency power save mode may cause interference, the logic control input MODE pin forces fixed frequency PWM operation under all load conditions.

The MP2155 operates with input voltage from 2V to 5.5V to provide adjustable output voltage (1.5V to 5V). With an input from 2.7V to 5.5V it can supply a maximum 1A current to load at 3.3V output voltage. The MP2155 is available in small QFN10-3x3mm package.

FEATURES

- High Efficiency up to 95%.
- Load Disconnect During Shutdown
- Input Voltage Range: 2V to 5.5V
- Adjustable Output Voltage from 1.5V to 5V
- 3.3V/1A Load Capability from 2.7V-to-5.5V V_{IN}
- 1MHz Switching Frequency
- Pulse Skipping Mode at Light Load
- Typical 80 μ A Quiescent Current
- Internal Loop Compensation for Fast Response
- Internal Soft Start
- OTP, Hiccup SCP
- Available in Small 3x3mm QFN10 Package

APPLICATIONS

- Battery-Powered Products
- Portable Instruments
- Tablet PCs
- POS Systems
- GSM/GPRS
- System Controls

All MPS parts are lead-free and adhere to the RoHS directive. For MPS green status, please visit MPS website under Quality Assurance.

"MPS" and "The Future of Analog IC Technology" are Registered Trademarks of Monolithic Power Systems, Inc.

TYPICAL APPLICATION

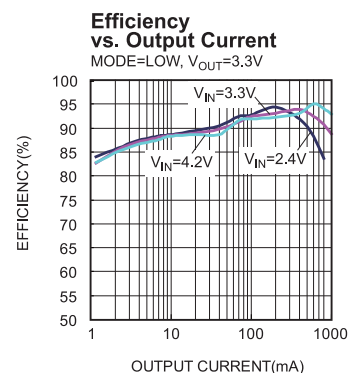
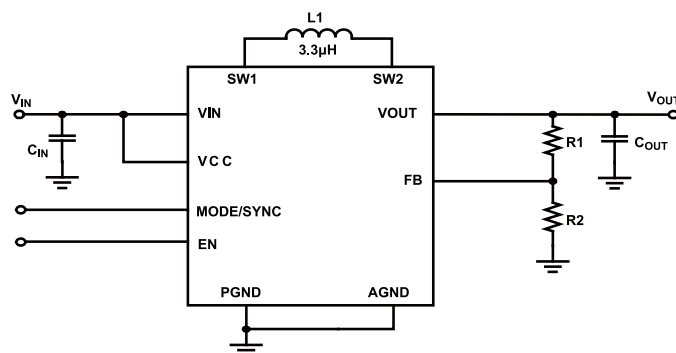

ORDERING INFORMATION

Part Number*	Package	Top Marking
MP2155GQ*	QFN10 (3X3)	ADR

* For Tape & Reel, add suffix -Z (e.g. MP2155GQ-Z);

PACKAGE REFERENCE

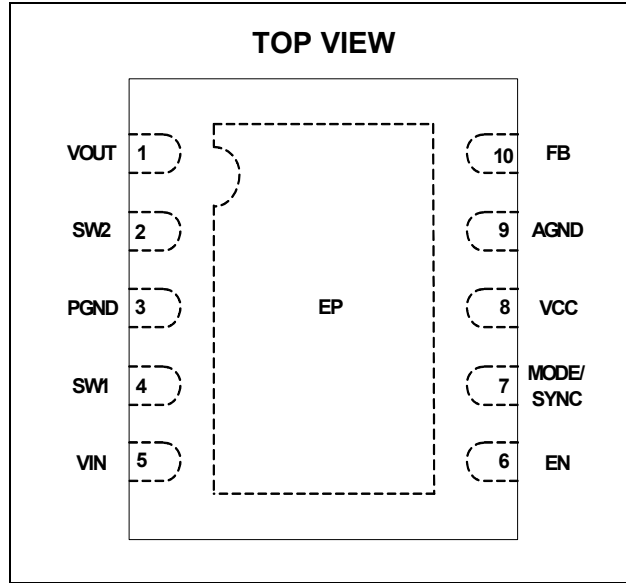

ABSOLUTE MAXIMUM RATINGS ⁽¹⁾

IN to GND	-0.3V to 6.5V
SW1/2 to GND	-0.3V(-2V for <10ns) to 6.5V
All Other Pins	-0.3V to 6.5 V
Junction Temperature	150°C
Lead Temperature	260°C
Continuous Power Dissipation (T _A = +25°C) ⁽³⁾	
QFN10 3X3mm	2.5W
Storage Temperature.....	-65°C to +150°C

Recommended Operating Conditions ⁽⁴⁾

Supply Voltage V _{IN}	2V to 5.5V
Output Voltage V _{OUT}	1.5V to 5V
Operating Junct. Temp. (T _J)....	-40°C to +125°C

Thermal Resistance ⁽⁵⁾	θ_{JA}	θ_{JC}
3X3 QFN10.....	50	12... °C/W

Notes:

- 1) Exceeding these ratings may damage the device
- 2) The maximum allowable power dissipation is a function of the maximum junction temperature T_J (MAX), the junction-to-ambient thermal resistance θ_{JA} , and the ambient temperature T_A. The maximum allowable continuous power dissipation at any ambient temperature is calculated by P_D (MAX) = (T_J (MAX)-T_A)/ θ_{JA} . Exceeding the maximum allowable power dissipation will cause excessive die temperature, and the regulator will go into thermal shutdown. Internal thermal shutdown circuitry protects the device from permanent damage.
- 3) The device is not guaranteed to function outside of its operating conditions.
- 4) Measured on JESD51-7, 4-layer PCB.

ELECTRICAL CHARACTERISTICS

$V_{IN} = V_{CC} = V_{EN} = 3.3V$, $T_J = 25^\circ C$, unless otherwise noted.

Parameter	Symbol	Condition	Min	Typ	Max	Units
Under voltage lockout threshold	V_{UVLO}	V_{CC} rising		1.8	1.9	V
		V_{CC} falling		1.60		V
Feedback voltage	V_{FB}		486	496	506	mV
Oscillator frequency	F_{REQ}		900	1000	1300	kHz
Frequency range for synchronization			1000		2000	kHz
Primary current limit	I_{sw}		1.8	2.2		A
Secondary current limit				1.8		A
NMOS switch on resistance	$R_{DS(ON)-N}$			105		m Ω
PMOS switch on resistance	$R_{DS(ON)-P}$			120		m Ω
Quiescent current	I_Q	$V_{FB} = 0.65V$		80		μA
Shutdown current	I_S	$V_{EN} = 0V$			1	μA
MODE input low voltage					0.4	V
MODE input high voltage			1.2			V
EN input low voltage					0.4	V
EN input high voltage			1.2			V
EN input current	I_{EN}	$V_{EN} = 3.3V$		3.1		μA
		$V_{EN} = 0V$		0		μA
Thermal shutdown ⁽⁵⁾	T_{SHDN}			160		$^\circ C$
Thermal shutdown hysteresis ⁽⁵⁾	T_{HYS}			20		$^\circ C$

Notes:

5) Guaranteed by engineering sample Characterization, not tested in production.

TYPICAL CHARACTERISTICS

$V_{IN} = 3.3V$, $V_{OUT} = 3.3V$, $L = 3.3\mu H$, $C_{OUT}=2x22\mu F$, $T_A = +25^\circ C$, unless otherwise noted.

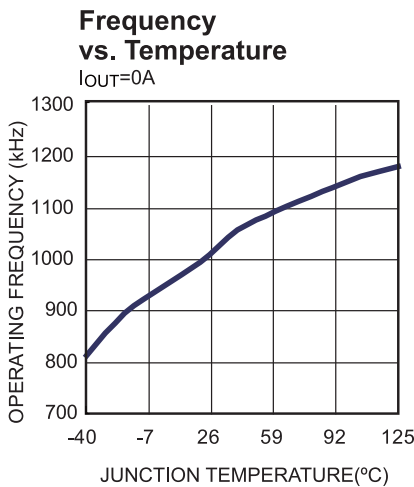
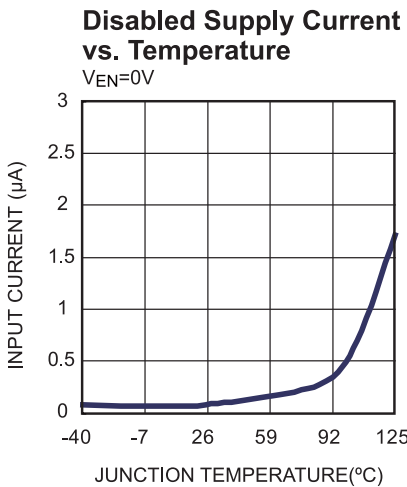
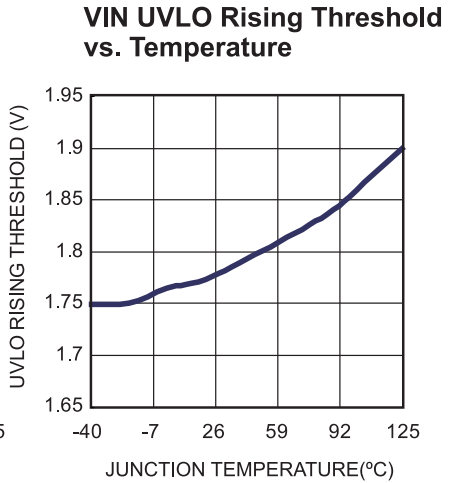
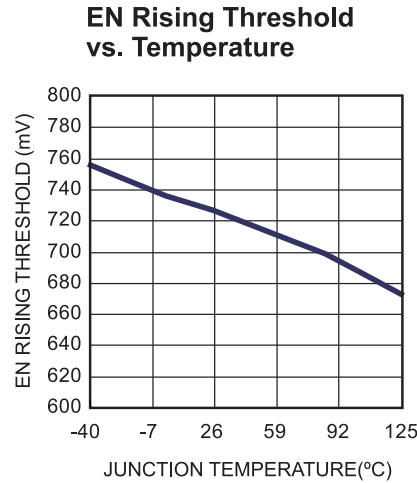
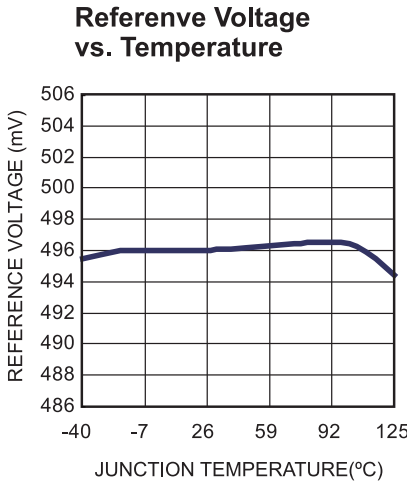
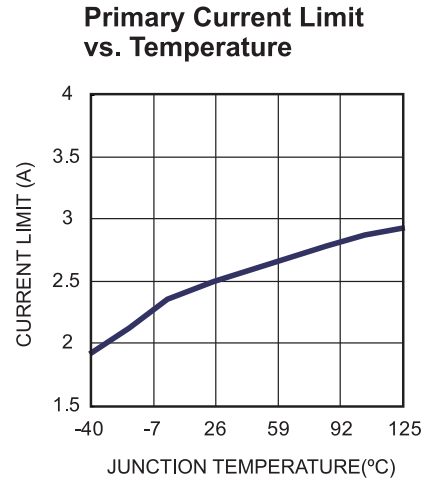
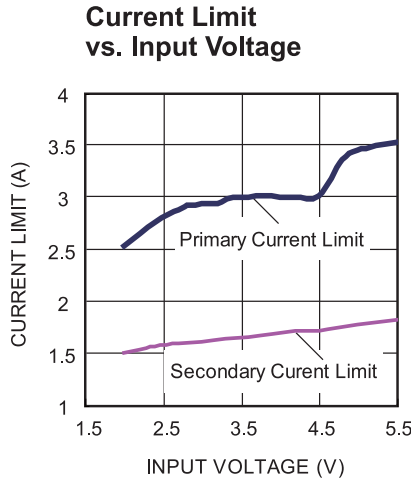
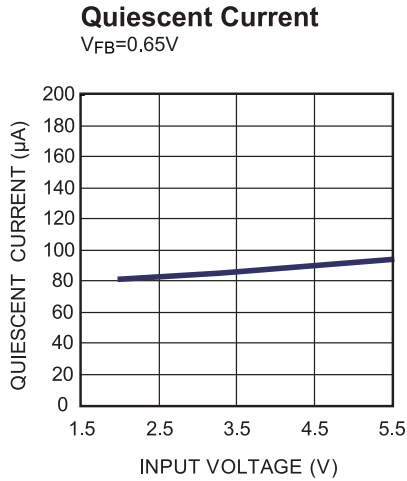

TYPICAL PERFORMANCE CHARACTERISTICS

$V_{IN} = 3.3V$, $V_{OUT} = 3.3V$, $L = 3.3\mu H$, $C_{OUT}=2 \times 22\mu F$, $T_A = +25^\circ C$, unless otherwise noted.

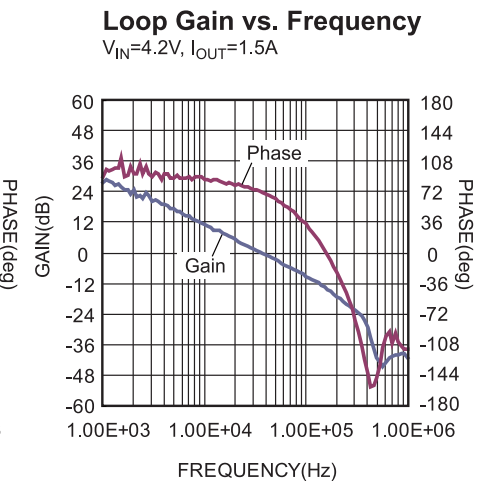
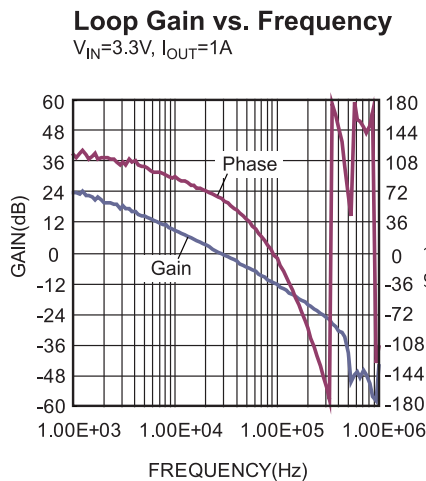
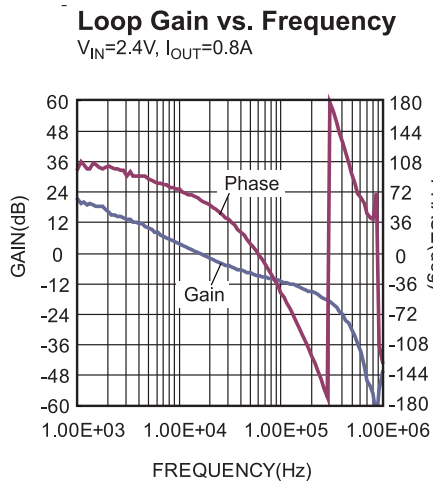
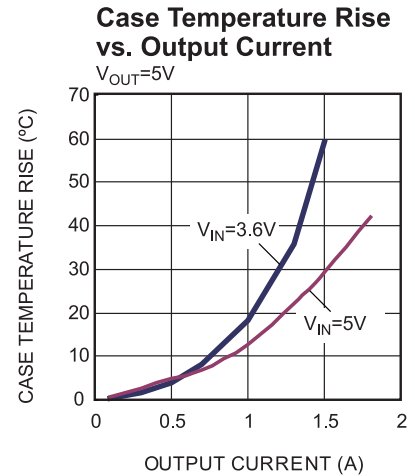
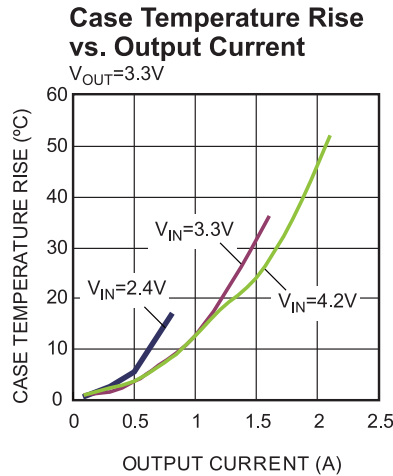
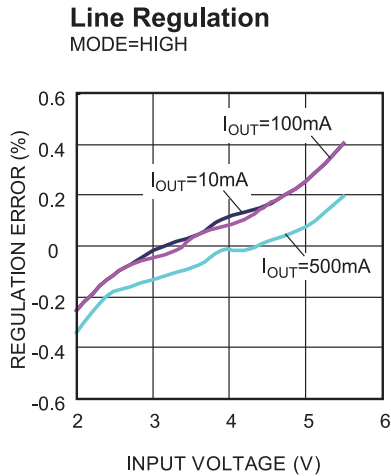
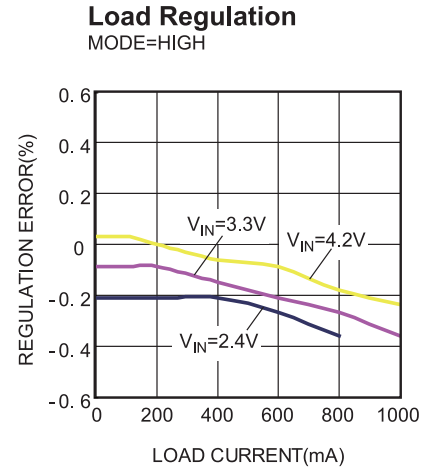
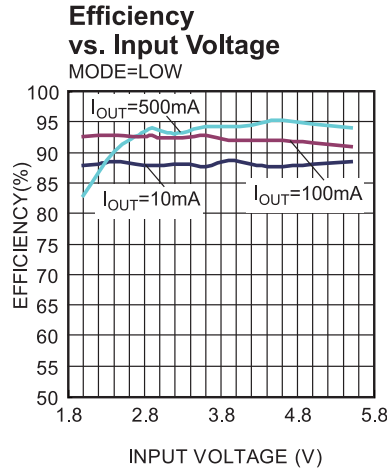
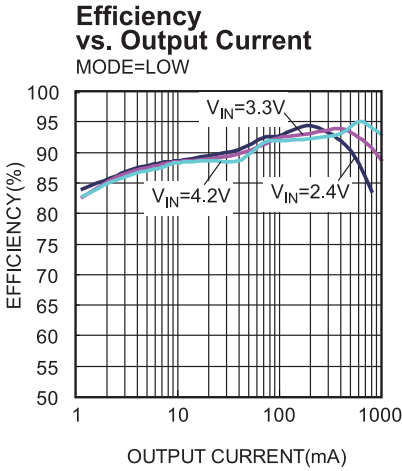

TYPICAL PERFORMANCE CHARACTERISTICS (continued)

$V_{IN} = 3.3V$, $V_{OUT} = 3.3V$, $L = 3.3\mu H$, $C_{OUT}=2x22\mu F$, $T_A = +25^{\circ}C$, unless otherwise noted.

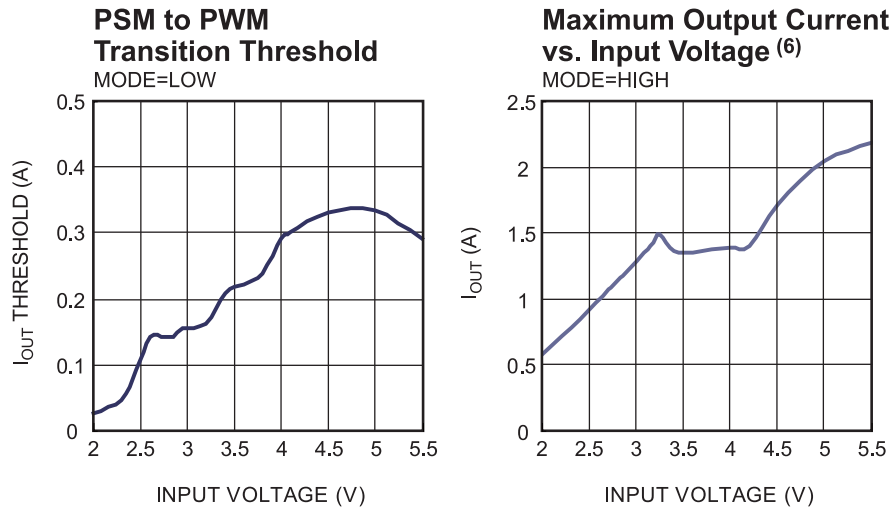

Notes:

6) Tested with 1.8A inductor peak current at 3.3V input point. Under other V_{IN} conditions, it takes the same current limit variation trend with V_{IN} into consideration as “Current Limit vs. Input Voltage” curve shows”

TYPICAL PERFORMANCE CHARACTERISTICS (continued)

$V_{IN} = 3.3V$, $V_{OUT} = 3.3V$, $L = 3.3\mu H$, $C_{OUT}=2 \times 22\mu F$, $T_A = +25^\circ C$, unless otherwise noted.

Line Transient Response

$V_{IN}=2.4V \rightarrow 3.3V$, $I_{OUT}=1A$

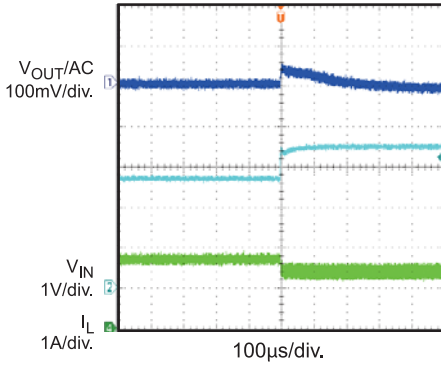

Line Transient Response

$V_{IN}=3.3V \rightarrow 2.4V$, $I_{OUT}=1A$

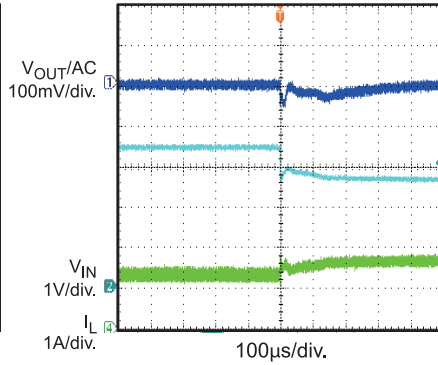

Line Transient Response

$V_{IN}=3.3V \rightarrow 4.2V$, $I_{OUT}=1A$

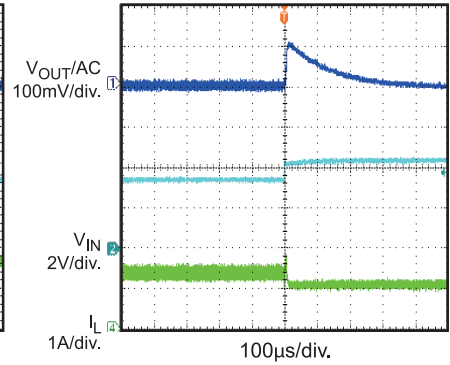

Line Transient Response

$V_{IN}=4.2V \rightarrow 3.3V$, $I_{OUT}=1A$

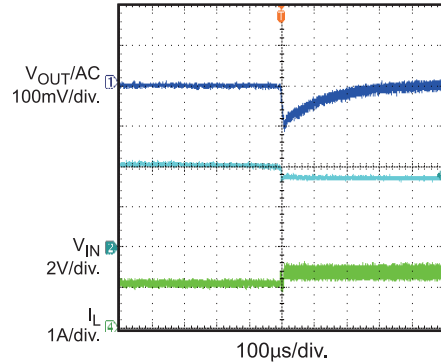

Power Up

$V_{IN}=4.2V$, $I_{OUT}=0A$, MODE=HIGH

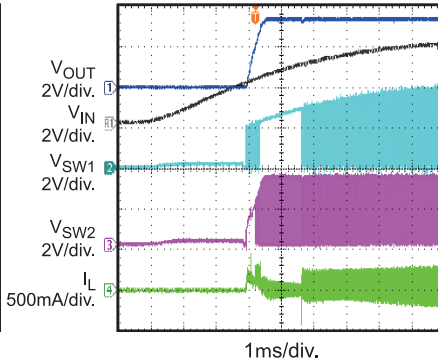

Power Up

$V_{IN}=4.2V$, $I_{OUT}=0.5A$, MODE=HIGH

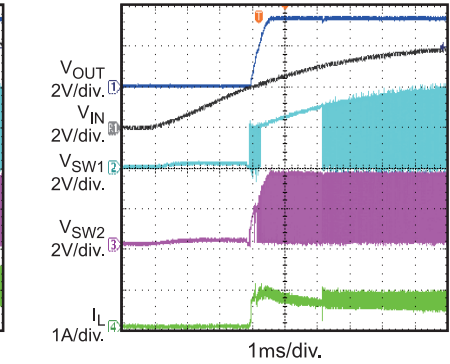

Power Off

$V_{IN}=4.2V$, $I_{OUT}=1A$, MODE=HIGH

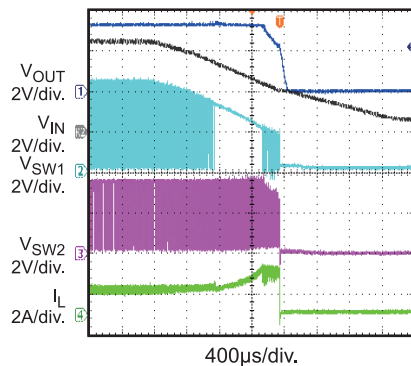

Power Off

$V_{IN}=4.2V$, $I_{OUT}=0.05A$, MODE=LOW

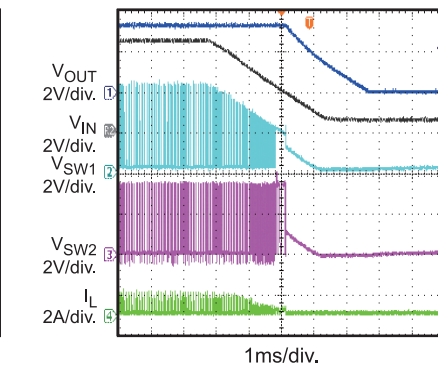

EN Start Up

$V_{IN}=2.4V$, $I_{OUT}=0A$, MODE=HIGH

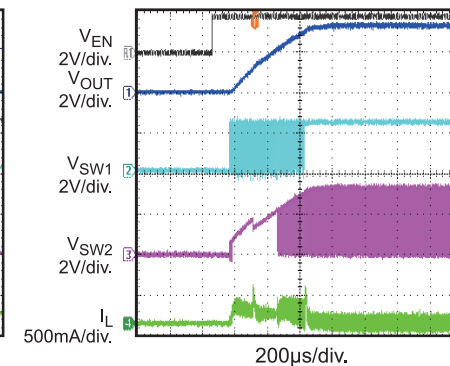

TYPICAL PERFORMANCE CHARACTERISTICS (continued)

$V_{IN} = 3.3V$, $V_{OUT} = 3.3V$, $L = 3.3\mu H$, $C_{OUT}=2 \times 22\mu F$, $T_A = +25^\circ C$, unless otherwise noted.

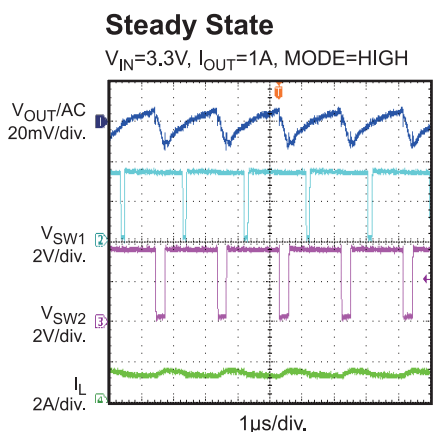
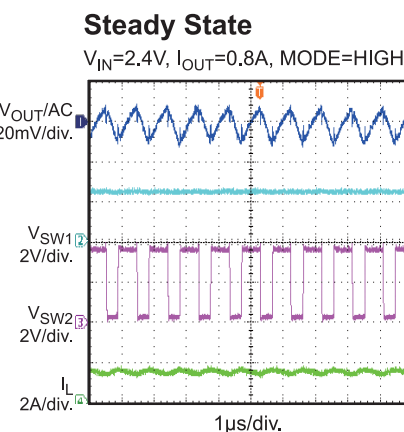
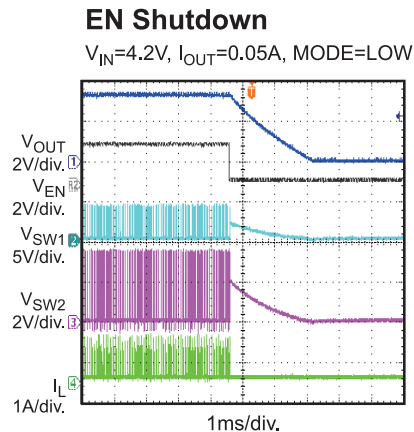
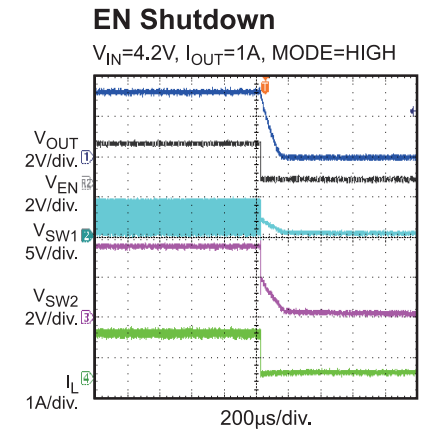
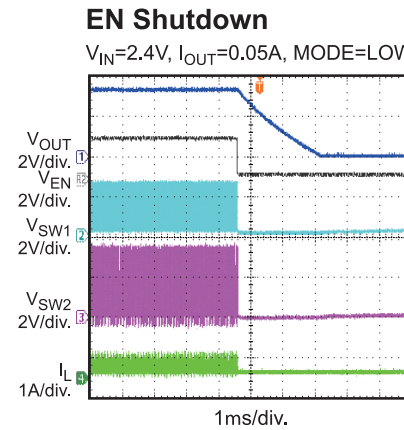
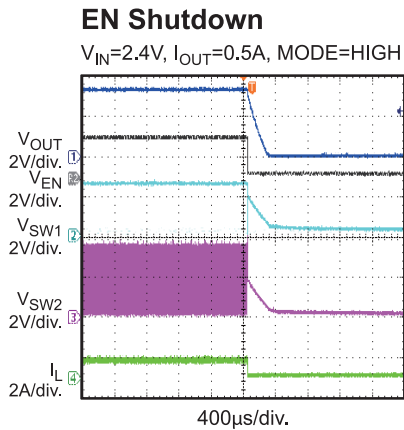
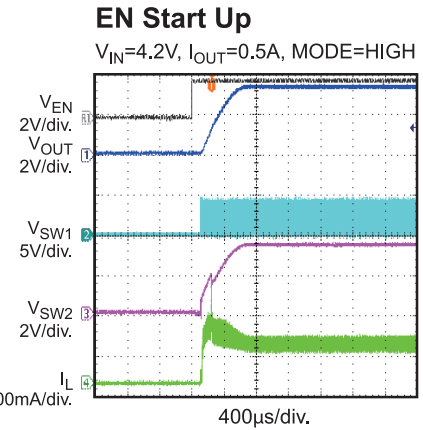
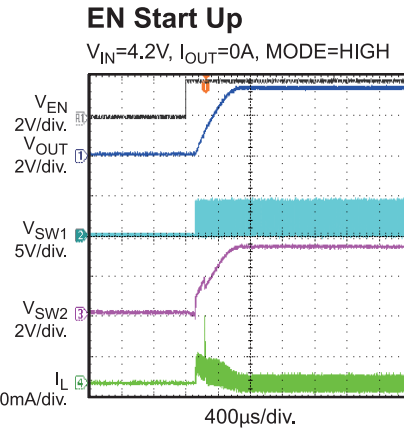
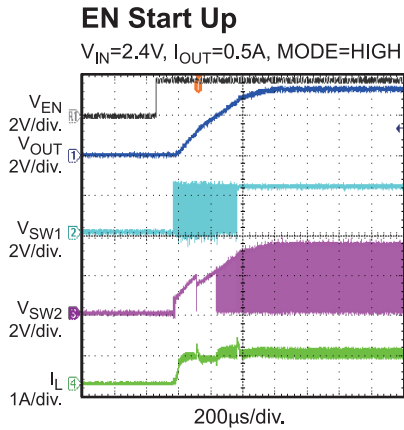

TYPICAL PERFORMANCE CHARACTERISTICS (continued)

$V_{IN} = 3.3V$, $V_{OUT} = 3.3V$, $L = 3.3\mu H$, $C_{OUT}=2 \times 22\mu F$, $T_A = +25^\circ C$, unless otherwise noted.

Steady State

$V_{IN}=4.2V$, $I_{OUT}=1.5A$, MODE=HIGH

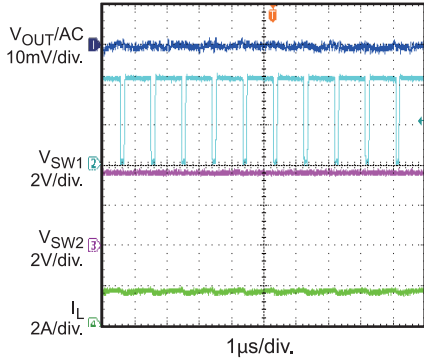

Steady State

$V_{IN}=2.4V$, $I_{OUT}=0.05A$, MODE=LOW

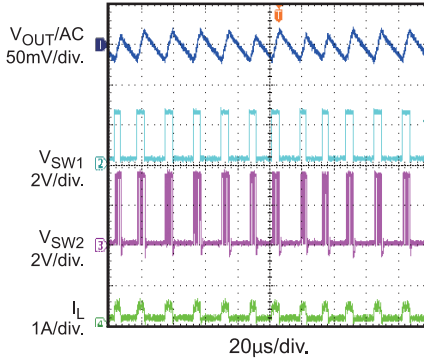

Steady State

$V_{IN}=3.3V$, $I_{OUT}=0.05A$, MODE=LOW

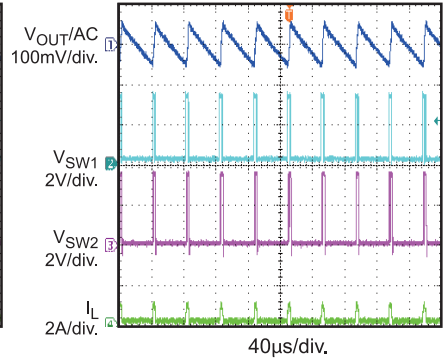

Steady State

$V_{IN}=4.2V$, $I_{OUT}=0.05A$, MODE=LOW

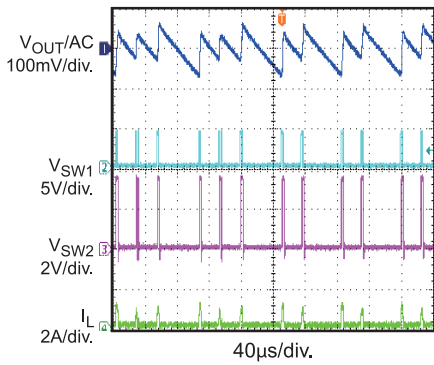

Load Transient Response

$V_{IN}=2.4V$, $I_{OUT}=0.2 \rightarrow 0.6A$ @250mA/µs, MODE=HIGH

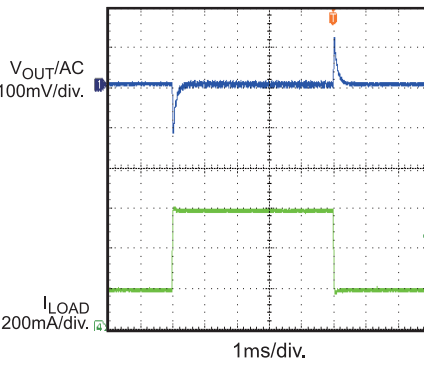

Load Transient Response

$V_{IN}=3.3V$, $I_{OUT}=0.2 \rightarrow 0.8A$ @250mA/µs, MODE=HIGH

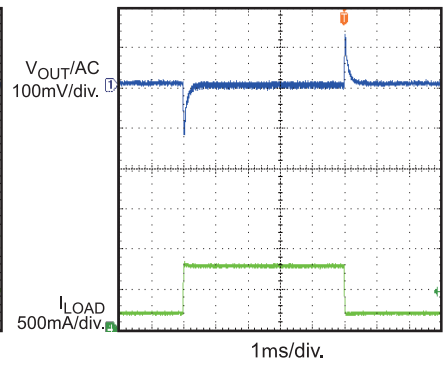

Load Transient Response

$V_{IN}=4.2V$, $I_{OUT}=0.3 \rightarrow 1A$ @250mA/µs, MODE=HIGH

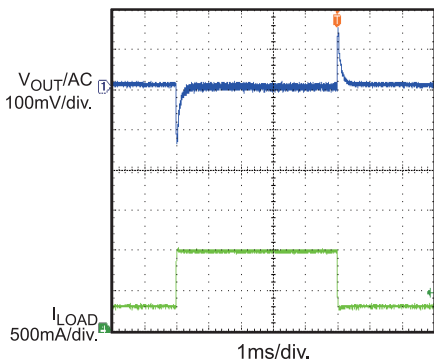

SCP Entry

$V_{IN}=2.4V$, $I_{O}=0.5A$, MODE=HIGH

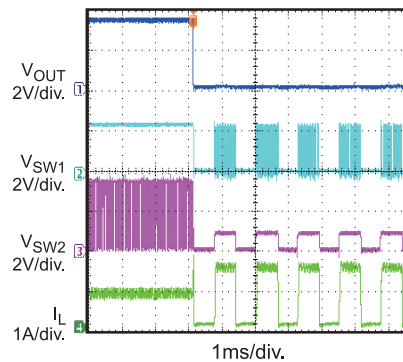

SCP Recovery

$V_{IN}=2.4V$, $I_{OUT}=0.5A$, MODE=HIGH

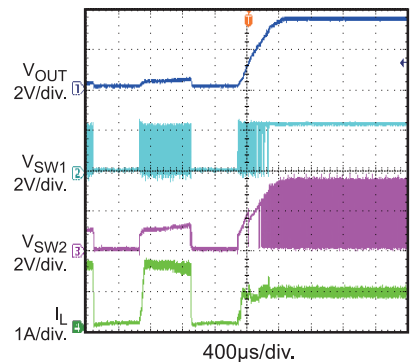

TYPICAL PERFORMANCE CHARACTERISTICS (continued)

$V_{IN} = 3.3V$, $V_{OUT} = 3.3V$, $L = 3.3\mu H$, $C_{OUT} = 2 \times 22\mu F$, $T_A = +25^\circ C$, unless otherwise noted.

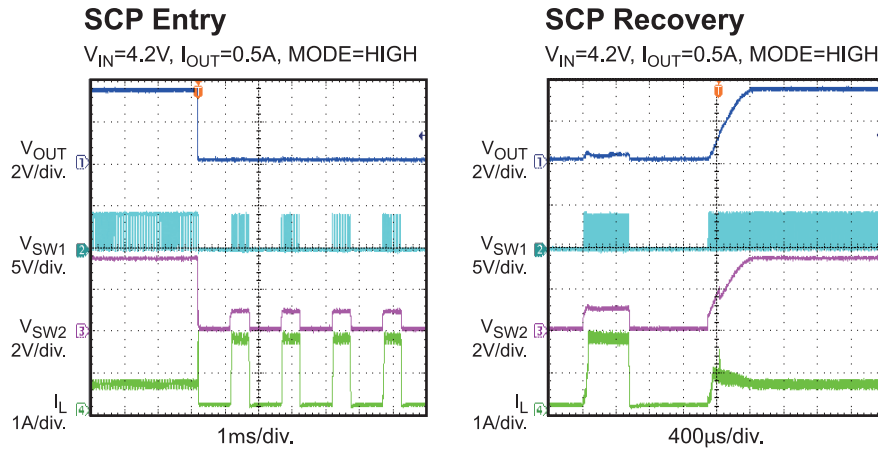

PIN FUNCTIONS

Pin #	Name	Description
1	VOUT	Buck-Boost converter output.
2	SW2	Switch pin-Internal switches are connected to this pin. Connect inductor between SW1 and SW2.
3	PGND	Power ground.
4	SW1	Switch pin-Internal switches are connected to this pin. Connect inductor between SW1 and SW2.
5	VIN	Supply voltage for power stage.
6	EN	ON/OFF control, it's not recommended to leave this pin float.
7	MODE/ SYNC	Operation mode selection. If MODE pin is low, the MP2155 automatically switches between PSM and fixed frequency PWM according to the load level. If MODE pin is pulled high, the MP2155 works always in PWM mode. External clock can be applied to MODE pin for changing switching frequency. This pin is sensitive to noise, so it should be strongly pulled up above 1.2V or pulled down below 0.4V. Must NOT leave it float.
8	VCC	Supply voltage for control stage.
9	AGND	Signal ground, should be connected to PGND externally.
10	FB	Feedback to set output voltage. Keeps this pin and associated trace far from noise source like SW.
-	EP	Thermal pad, which is recommended to connected to PGND.

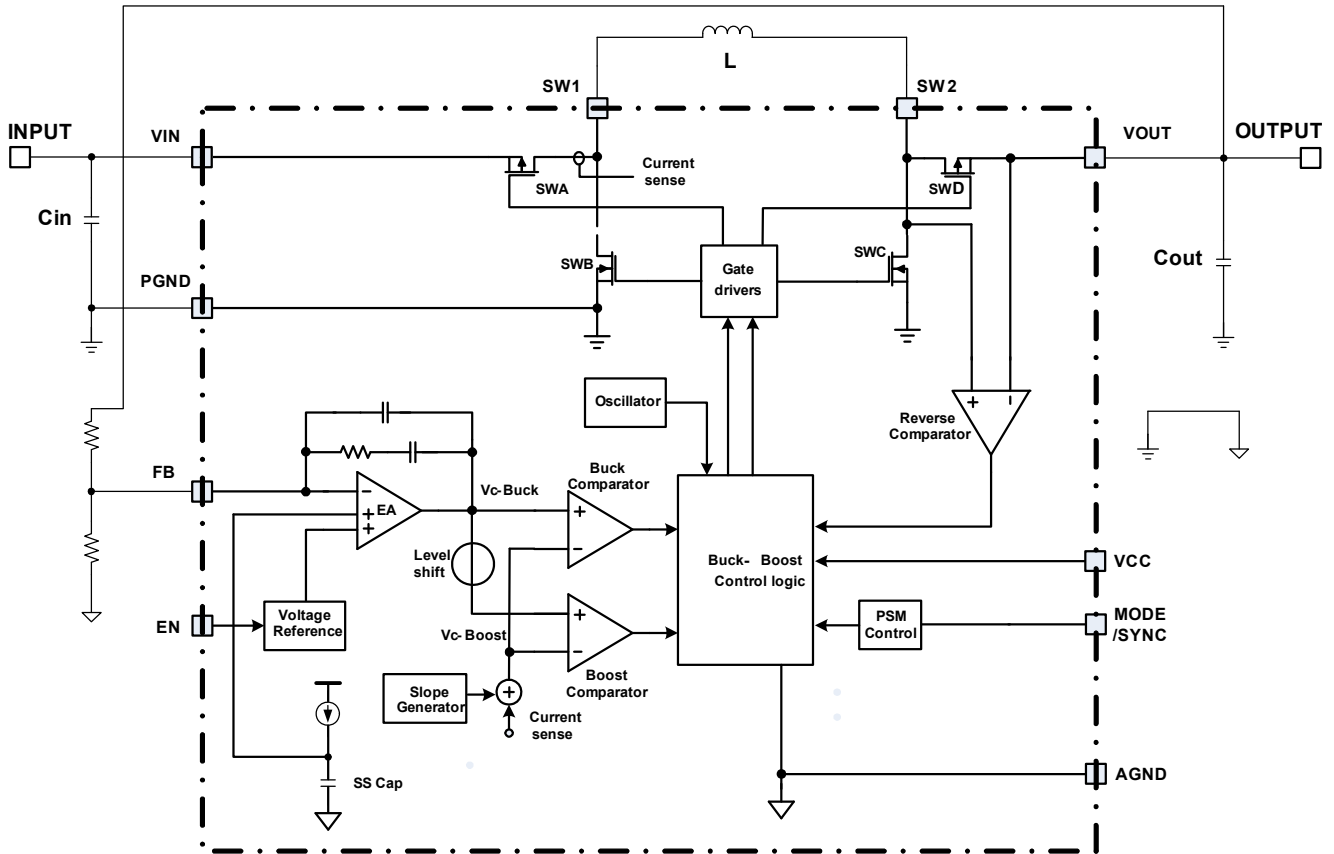

Figure 1— Function Block Diagram

OPERATION

The MP2155 is a high efficiency, dual mode buck-boost converter that provides output voltage above, equal to or below the input voltage. When the MODE pin is held high, the MP2155 operates in constant-frequency PWM mode with peak current mode control. As shown in Figure 1, the output voltage is sensed via the FB pin through an external resistor-divider from the output to ground. The voltage difference between FB pin and the internal reference is amplified by error amplifier to generate control signal V_{C-Buck} . By comparing V_{C-Buck} with internal compensation ramp (the sensed SWA's current with slope compensation) through Buck comparator, a PWM control signal for PWM buck mode is outputted. Another control signal $V_{C-Boost}$ is derived from V_{C-Buck} through level shift. Similarly, $V_{C-Boost}$ compares with the same ramp signal through Boost comparator and generates the PWM control signal for PWM boost mode. The switch topology for the buck-boost converter is shown in Figure 2.

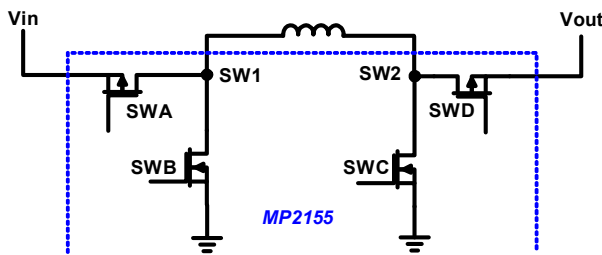

Figure 2—Buck-Boost Switch Topology

Buck Region ($V_{in} > V_{out}$)

When the input voltage is significantly greater than output voltage, which means the converter can deliver energy to load within the maximum duty cycle of SWA, so the converter operates in buck mode. The control signal $V_{C-Boost}$ is always lower than compensation ramp because Buck can deliver enough energy to load, thus switch D turns on constantly and switch C remains off. Meanwhile, V_{C-Buck} compares with compensation ramp normally and generates PWM signal, therefore, switches A and B are pulse-width-modulated to produce the required duty cycle to support the output voltage.

Buck-Boost Region ($V_{in} \approx V_{out}$)

When V_{in} is close to V_{out} , due to duty cycle limit of SWA the converter isn't able to provide wanted energy to load. In this case SWA will be turned on over all the period, that is, there is no BD operation (SWB and SWD being turned on simultaneously). Now a new period begins. Since there is no BD in last period, an offset voltage is added to the ramp signal to make the ramp signal easily hit V_{C-Buck} . At the same time due to loop regulation $V_{C-Boost}$ (as well as V_{C-Buck}) rises to some level, so that the ramp signal can intersect it to produce the PWM driving signal for Boost operation. After SWC is turned off the ramp signal continues rising (the actual inductor current may rise or fall depending on the difference between V_{in} and V_{out}), when the ramp intersects V_{C-Buck} , PWM signal for Buck operation then is generated. Now the buck's duty cycle is within its limit, so there is BD operation in current period, which means next period the offset voltage will be removed. This is the so-called buck-boost region. With heavy load due to voltage drop on switches the actual input range for this region may be a little wide.

Boost Region ($V_{in} < V_{out}$)

When the input voltage is significantly lower than output voltage, the converter operates in boost mode. The control signal V_{C-Buck} is always higher than compensation ramp even with the offset voltage always added, thus switch A turns on continuously and switch B remains off. Meanwhile, $V_{C-Boost}$ compares compensation ramp normally and generates PWM signal, therefore, switches C and D are pulse-width-modulated to produce the required duty cycle to support the output regulation voltage.

PSM

When Mode Pin is pulled down below the low level threshold, the MP2155 will automatically enter PSM if load is light. When working in PSM, a train of SW pulses are initiated by a Boost operation, and ended with BD operation. During this process, SWD will be turned off if inductor current is below about 100mA. In actual

waveforms the current may be much lower than this value when SWD is turned off because of internal delay.

SCP/OCP vs. two current limits

There are two current limits in MP2155. The primary one is for steady PWM operation and it's typically from 2A to 3A, depending on V_{in} ; The secondary one is for limiting inrush current at startup, it's typically 1.6A to 1.9A, depending on V_{in} , too. When load is over heavy, the primary limit would protect MP2155 from being over thermal. Therefore V_{out} would drop due to OCP. If V_{out} drops below 0.6 times normal output, a hiccup period is initiated to protect MP2155. this is the SCP. In hiccup period, SWA and SWC are turned off while SWB and SWD are turned on. After the hiccup period ends, a soft re-startup begins. Because V_{out} is below 1V (due to over load or output short), the secondary current takes charge of this process. After V_o rises above 1V, primary current limit get in charge of. Now if load is still over heavy (or output short still exists) such that after SS ends V_{out} is still below $0.6 \cdot V_{OUT_NORMAL}$ and current hits one of the limits, another hiccup period begins. However if the load recovers to normal value during re-startup so that current doesn't hit its limit, or, V_{out} already rises above $0.6 \cdot V_{OUT_NORMAL}$, the re-startup succeeds, and MP2155 enter normal operation.

As to the input/EN startup, the cases are same as the SCP recovery process.

Enable

The MP2155 has a dedicated enable control pin (EN). The device operates when it is set high. If it is set low the device stops switching, all the internal blocks are turned off. Tie EN to V_{in} through a resistor for automatic start up. Due to EN bias or leakage current, the value of this resistor should be set to provide EN pin with a current above 10uA. Any signal to drive this pin should be limited to 100uA if the maximum voltage of this signal is above 6.5V.

Internal Soft-start

When EN pin is pulled high, and at the same time the voltage on V_{cc} pin is above its UVLO rising threshold MP2155 will start up with Soft-start function to eliminate output overshoot. Soft-start also functions during SCP recovery.

Under-Voltage Lockout

The under voltage lockout (UVLO) is implement to protect the device from improper operating at insufficient supply voltage. When the supply voltage at V_{CC} is below the UVLO threshold the device is in shutdown mode. The UVLO rising threshold is about 1.8V with 200mV hysteresis.

Over-Temperature Protection

An internal temperature sensor continuously monitors the IC junction temperature. If the IC temperature exceeds 160°C typically the device stops operating. As soon as the temperature falls below 140 °C typically normal operation is restored.

APPLICATION INFORMATION

Setting the Output Voltage

To use MP2155 correctly, A resistor divider must be connected between Vout and GND, and the middle point of the divider connected to FB pin as shown in Typically Application on page 1.

$$R1 = \left(\frac{V_{OUT}}{V_{FB}} - 1 \right) \times R2 \quad (1)$$

High R2 resistance (eg. 100kΩ) can reduce the power consumption, while lower than 1MΩ resistance is recommended for R1 for good output accuracy.

Inductor Selection

The inductor is the key passive component for switching converters. With a buck-boost device, the inductor selection affects the boundary conditions in which the converter works, as buck at the maximum input voltage and as a boost at the minimum input voltage.

Two critical inductance values are then obtained according to the following formulas.

$$L_{MIN-BUCK} = \frac{V_{OUT} \times (V_{IN(MAX)} - V_{OUT})}{V_{IN(MAX)} \times F_{REQ} \times \Delta I_L} \quad (2)$$

$$L_{MIN-BOOST} = \frac{V_{IN(MIN)} \times (V_{OUT} - V_{IN(MIN)})}{V_{OUT} \times F_{REQ} \times \Delta I_L} \quad (3)$$

Where:

F_{REQ} : minimum switching frequency

ΔI_L : the peak-to-peak inductor ripple inductor current. As a rule of thumb, the peak-to-peak ripple can be set at 10%-20% of the output current.

The minimum inductor value for the application is the higher one between Equation 2 and Equation 3. In addition to the inductance value the maximum current the inductor can handle must be calculated in order to avoid saturation.

$$I_{PEAK-BUCK} = \frac{I_{OUT}}{\eta} + \frac{V_{OUT} \times (V_{IN(MAX)} - V_{OUT})}{2 \times V_{IN(MAX)} \times F_{REQ} \times L} \quad (4)$$

$$I_{PEAK-BOOST} = \frac{V_{OUT} \times I_{OUT}}{\eta \times V_{IN(MIN)}} + \frac{V_{IN(MIN)} \times (V_{OUT} - V_{IN(MIN)})}{V_{OUT} \times F_{REQ} \times L} \quad (5)$$

Where η is the estimated efficiency of MP2155. The maximum of the two values above must be considered when selecting the inductor.

Input and Output Capacitor Selection

It is recommended to use ceramic capacitors with low ESR as input and output capacitors in order to filter any disturbance present in the input line and to obtain stable operation.

Minimum values of 10uF for both capacitors are needed to achieve good behavior of the device.

The input capacitor must be placed as close as possible to the device.

Other Consideration

MP2155 employs the classic hiccup mode for SCP. This method has an inherited drawback: if the output short is released at a time closed to SS end, then Vo would has overshoot. To attenuate Vo overshoot at SCP recovery, a forward RC series can be connected in parallel with high side resistor of FB divider, as R3 and C5 in Figure 5 shows. The RC acts as a soft startup when Vo short is released at the time of internal SS's end.

PCB Layout Guide

1. Input and output capacitors should be close to MP2155's Vin, Vout and PGND pins.

2. The wire connecting input capacitor to Vcc pin should be as short as possible. For better performance in noisy environment, an additional capacitor very close to Vcc pin can be used to bypass noise for Vcc.

3. FB resistor divider should be very close to FB pin, and keep FB trace far away from noise.

Figure 3 shows an example of PCB layout for which the reference schematic is shown on Figure 4.

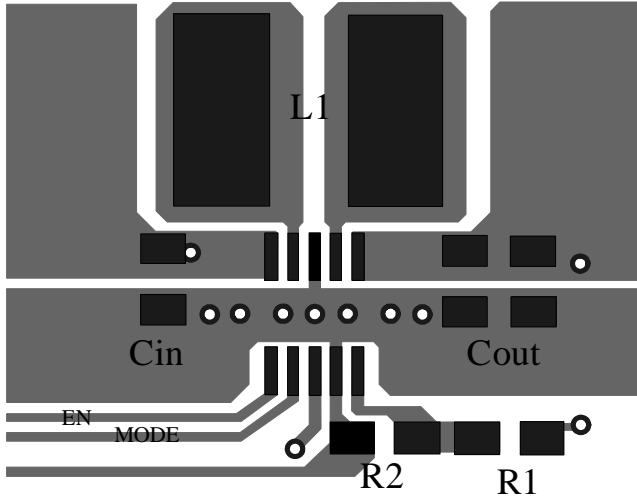

Top Layer

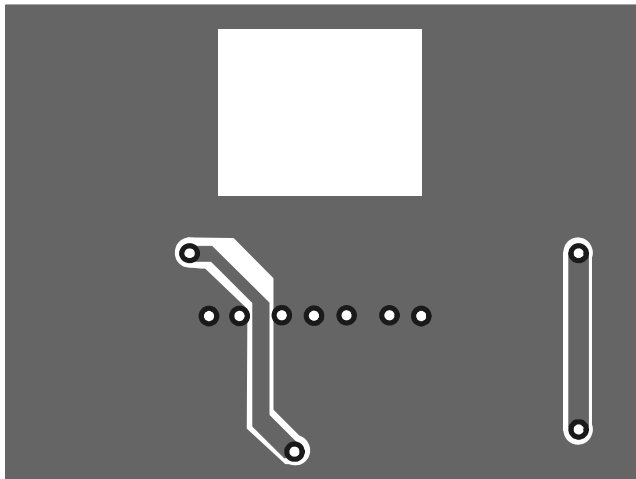

Bottom Layer

Figure 3—PCB Layout

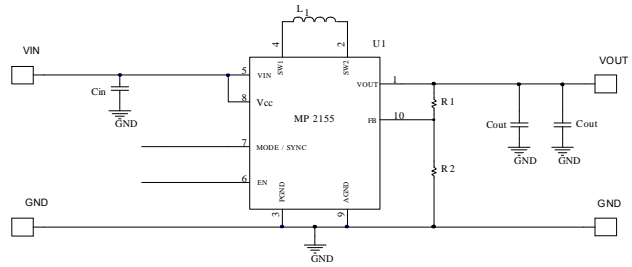

Figure 4—Reference Circuit for PCB Guide

Design Example

Below is a design example following the application guidelines for the specifications:

Table 1: Design Example

V_{IN} (V)	2-5.5
V_{OUT} (V)	3.3V

The detailed application schematic is shown in Figure 5 and its performance can be found in TPC section.

TYPICAL APPLICATION CIRCUITS

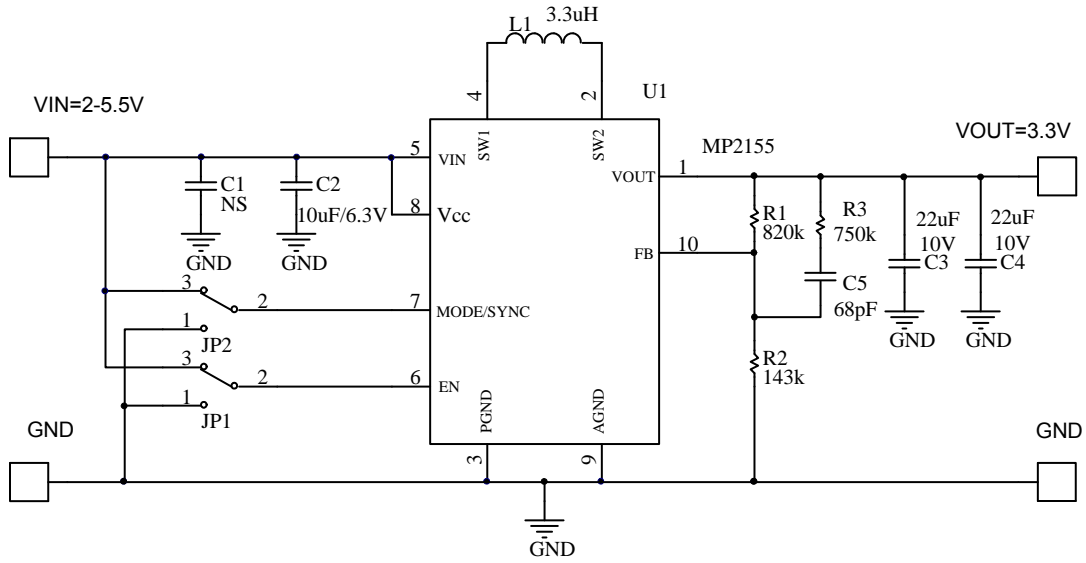

Figure 5—3.3V Output Application Circuit

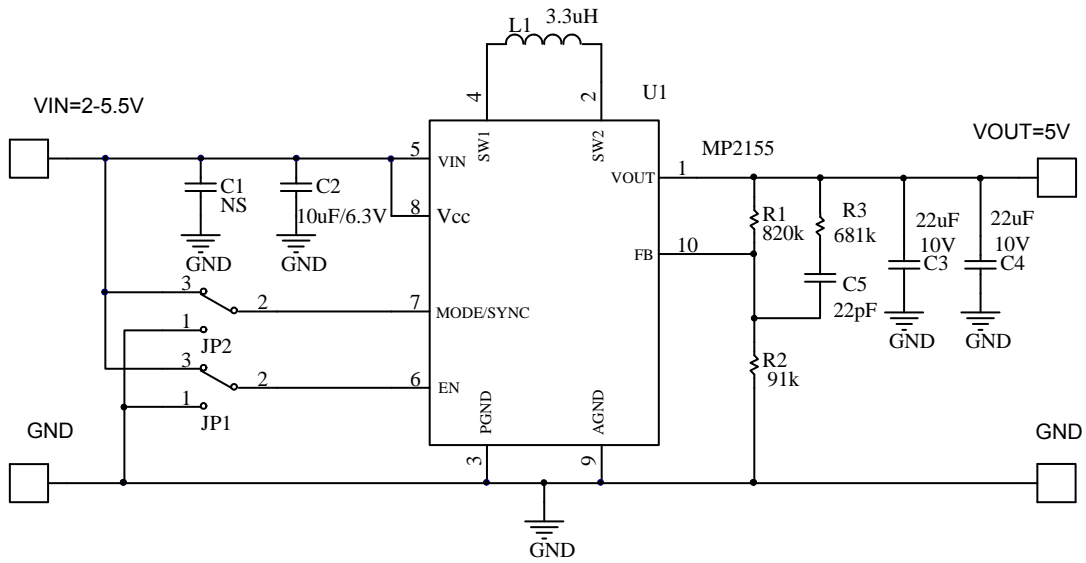
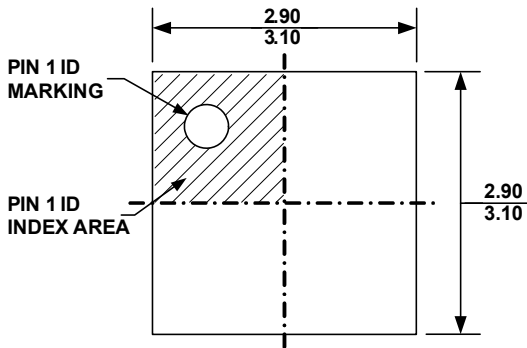

Figure 6—5V Output Application Circuit

PACKAGE INFORMATION

QFN10 (3mmX3mm)



TOP VIEW

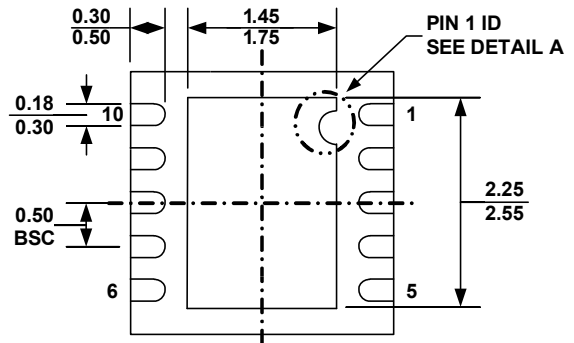

BOTTOM VIEW

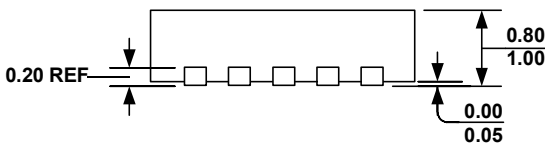

SIDE VIEW

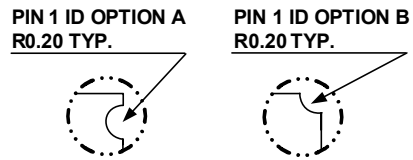

DETAIL A

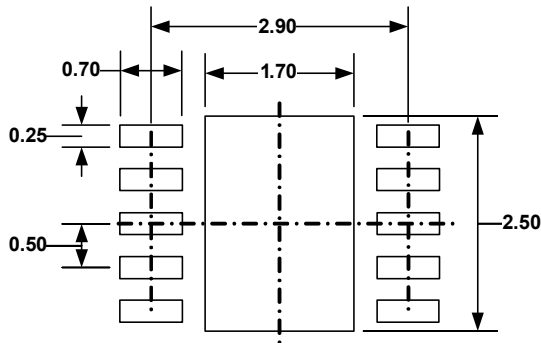

RECOMMENDED LAND PATTERN

NOTE:

- 1) ALL DIMENSIONS ARE IN MILLIMETERS
- 2) EXPOSED PADDLE SIZE DOES NOT INCLUDE MOLD FLASH
- 3) LEAD COPLANARITY SHALL BE 0.10 MILLIMETER MAX
- 4) DRAWING CONFORMS TO JEDEC MO-229, VARIATION VEED-5.
- 5) DRAWING IS NOT TO SCALE

NOTICE: The information in this document is subject to change without notice. Please contact MPS for current specifications. Users should warrant and guarantee that third party Intellectual Property rights are not infringed upon when integrating MPS products into any application. MPS will not assume any legal responsibility for any said applications.