

May.1.2023 Copyright 2023 HIROSE ELECTRIC CO., LTD. All Rights Reserved.  
In case of consideration for using Automotive equipment / device which demand high reliability, kindly contact our sales window correspondents.

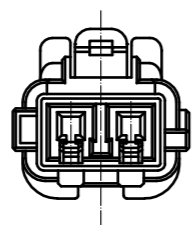
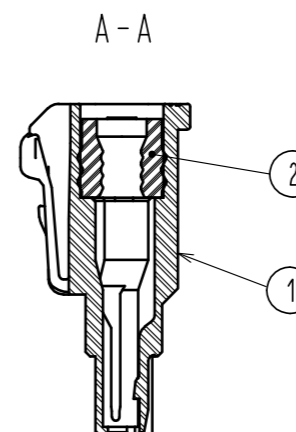
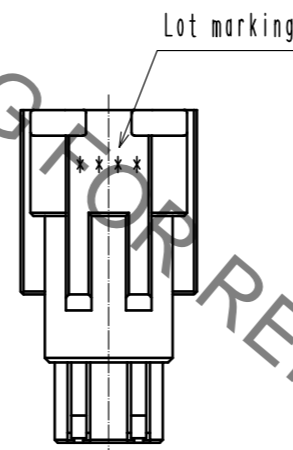
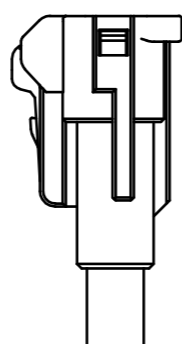
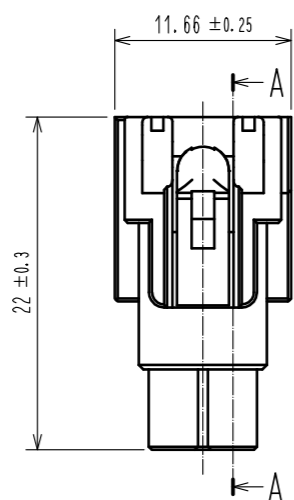
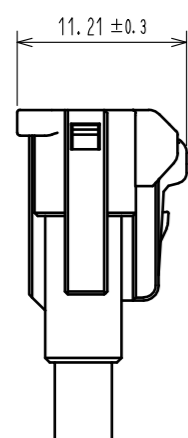
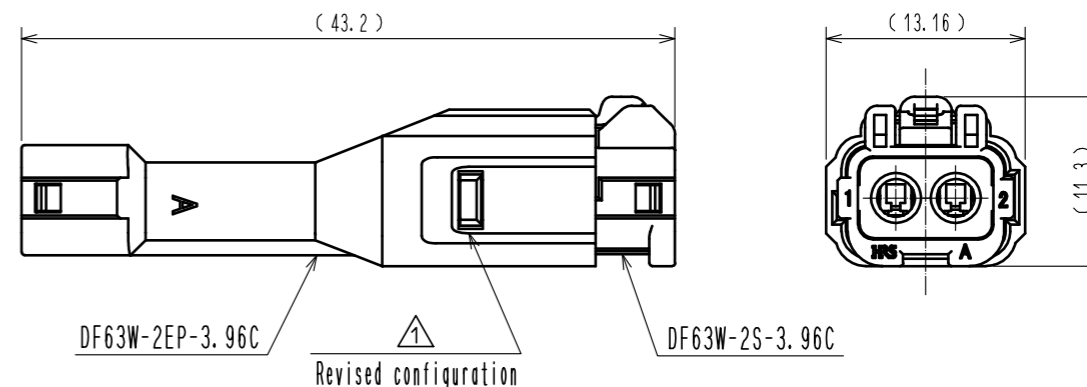
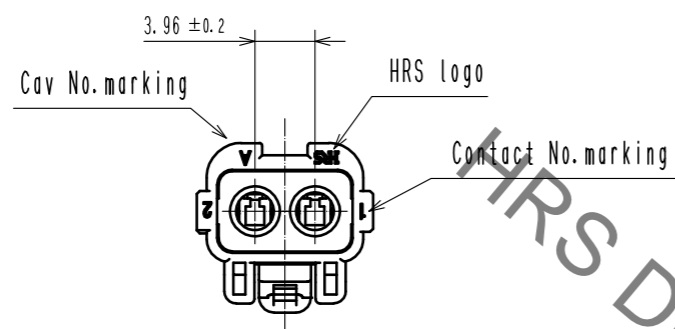

Notes.

1. 100 pcs. / pack
2. Applicable cable dia : φ2.8~φ3.2mm
3. The dimensions in parenthesis are reference dimensions.
4. Always refer to the manuals below for operation of this product.  
For cable assembly / ETAD-H0814

1	PBT	UL94V-0 (Black)	2	Silicone rubber	Blue		
NO.	MATERIAL	FINISH . REMARKS	NO.	MATERIAL	FINISH . REMARKS		
UNITS mm		SCALE 2 : 1	COUNT 1	DESCRIPTION OF REVISIONS DIS-H-00000434	DESIGNED TO. HORII	CHECKED HK. UMEHARA	DATE 15. 05. 14
<b>HRS</b> HIROSE ELECTRIC CO., LTD.		APPROVED : HK. UMEHARA	15. 03. 10	DRAWING NO. EDC-359255-00-00			
		CHECKED : HK. UMEHARA	15. 03. 10	PART NO. DF63W-2S-3. 96C			
		DESIGNED : TO. HORII	15. 03. 10	CODE NO. CL680-0613-7-00			
		DRAWN : TO. HORII	15. 03. 10				