

qBox AFC DIY IOT Enclosure Kits

User Manual

Abstract

User Manual describing the qBox AFC DIY IOT Enclosure Kits.
Kits features, content and project ideas provided.

IBT-QBX-AFC-X-UM

www.iot-bots.com





Table of Contents

Revision History	2
Overview.....	3
Features.....	3
Description	3
qBox AFC Enclosure Kit (No SMA)	4
qBox AFC Enclosure Kit (One SMA)	5
qBox AFC Enclosure Kit (Two SMAs).....	6
qBox AFC Enclosure Kit parts	6
Specification	13
qBox AFC Enclosure Kit content	13
Project ideas	14
Abbreviations.....	15
Trademark notice.....	15
Ordering info	15



Revision History

NoNo	Version	Date	Author	Description
1	1.0	12.26.2020	lotbotscom	Initial
2				
3				



Overview

Perfect for any DIY IOT project, qBox AFC Enclosure Kit series is the part of the newest HW platform designed to help hobbyists, makers and all DIYers to build environmental ready IOT solutions.

Features

- Flanged IP65 waterproof enclosure: Sealed, made of high-quality ABS material suitable for indoor and outdoor DIY IOT projects;
- Incorporated PG7 cable glands: Two cable inputs securely allow bringing the power in and connecting sensors and actuators;
- Perfect fit PCB: High-quality double-sided PCB with 0.1" hole spacing for DIP integrated circuits, modules, and main controller board;
- Dedicated placement for controller board: Well-designed PCB allows to carry Adafruit Feather Compatible MCU board;
- Built in SMA connectors: Up to two SMA Straight Female to IPEX (u.FL) adapter cables give external antennas connections to your wireless board;
- Rich connectors set installed: Four terminal blocks, Grove, 4-pin JST and 0.1" AFC compatible interface connectors.

Description

qBox AFC Enclosure Kits are part of qBox AxC Enclosure Kits line. qBox AxC Enclosure Kits line is based on qBox Enclosure Kits product line and developed especially to be used with AFC or AMC boards. So, each kit PCB has dedicated connectors main CPU board could be plugged in (AFC or AMC).

Each qBox AFC Enclosure Kit consists of durable waterproof IP65 enclosure with installed PG7 glands, double sided PCB with connectors installed and integrated SMA to u.FL adapter cable (up to two, depending on kit model) and connectors set.

qBox AFC Enclosure Kit (No SMA)

qBox AFC Enclosure Kit (No SMA) is the simplest member in qBox AFC Enclosure Kit family. It has no integrated SMA to u.FL adapter cable, but still able to keep wireless connectivity device with internal antennas.



Pic.1. qBox AFC Enclosure Kit (No SMA) common view

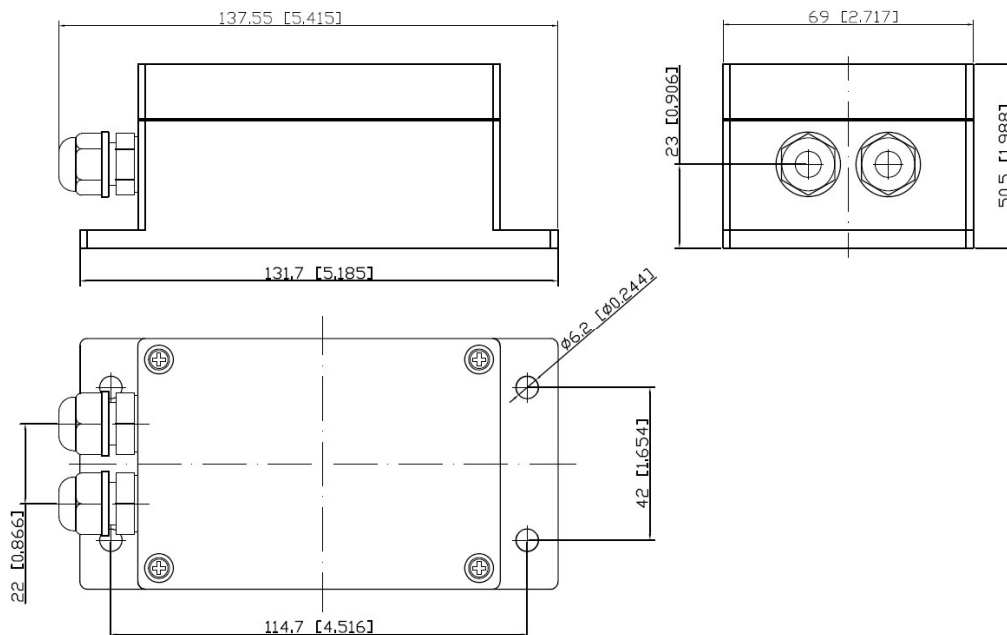

Pic. 2. qBox AFC Enclosure Kit (No SMA) dimensions

qBox AFC Enclosure Kit (One SMA)

qBox AFC Enclosure Kit (One SMA) is the member of qBox AFC Enclosure Kit family which is able to bring up to one external antenna signal to IOT device located inside. It has one integrated SMA to u.FL adapter cable.

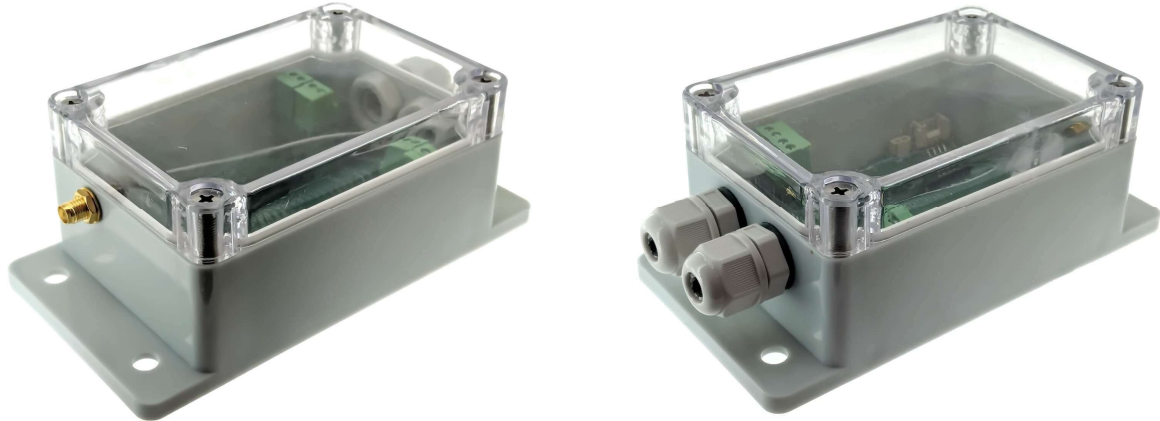

Pic.3. qBox AFC Enclosure Kit (One SMA) common view

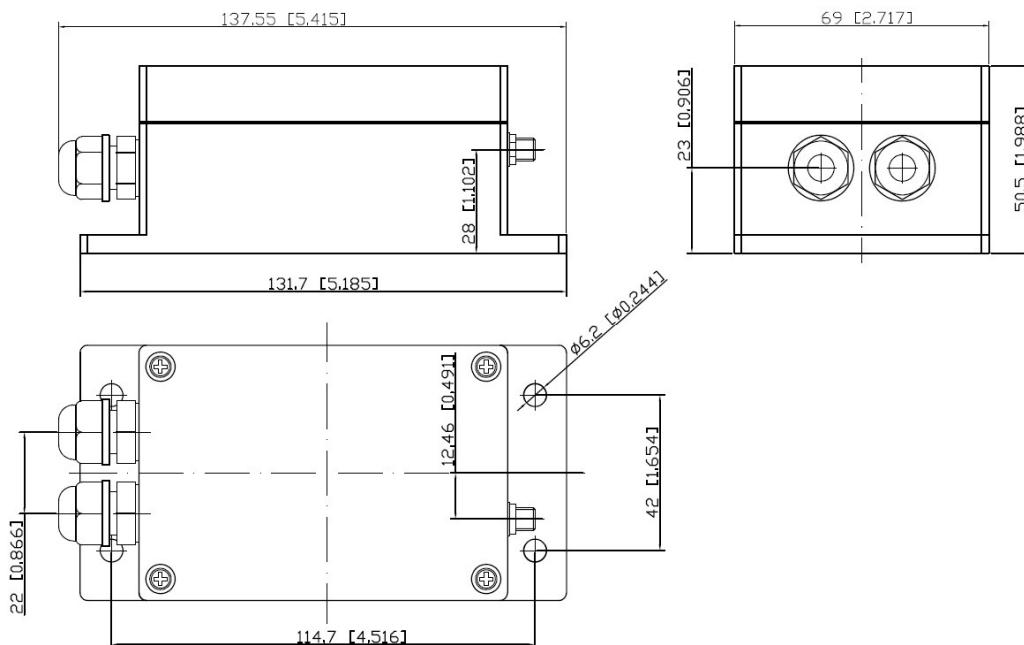

Pic. 4. qBox AFC Enclosure Kit (One SMA) dimensions

qBox AFC Enclosure Kit (Two SMAs)

qBox AFC Enclosure Kit (Two SMA) is the most charged member of qBox AFC Enclosure Kit family which has got two integrated SMA to u.FL adapter cables.

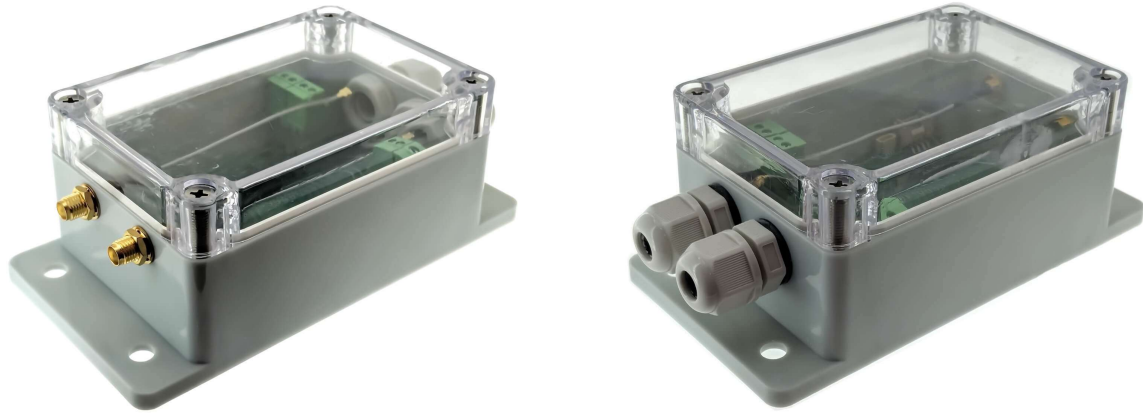

Pic.5. qBox AFC Enclosure Kit (Two SMAs) common view

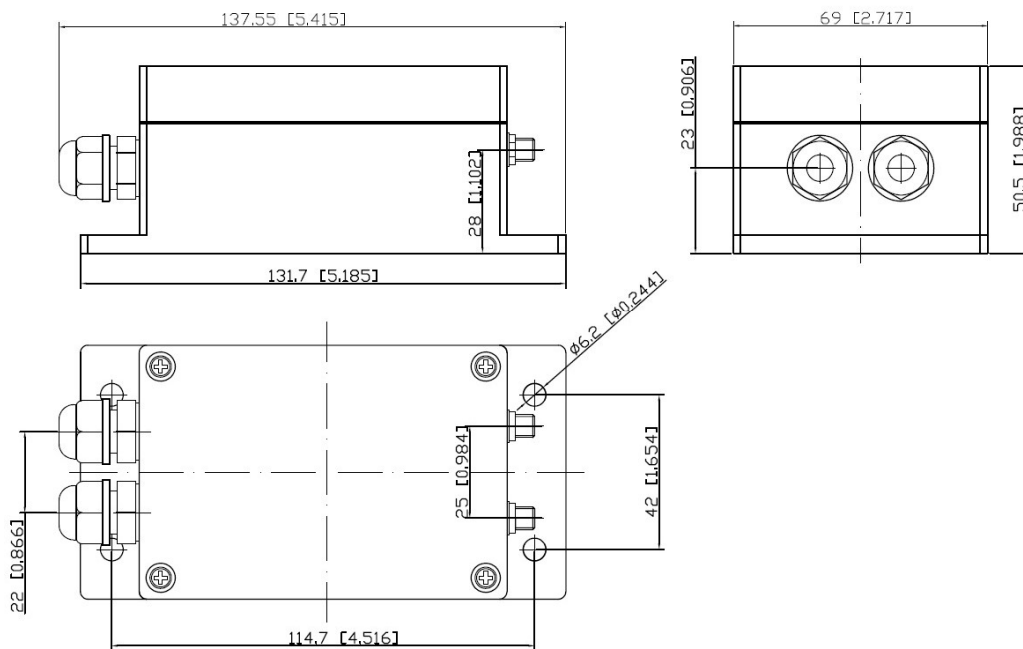

Pic. 6. qBox AFC Enclosure Kit (Two SMAs) dimensions

qBox AFC Enclosure Kit parts

Each qBox AFC Enclosure Kit has got several parts built in.

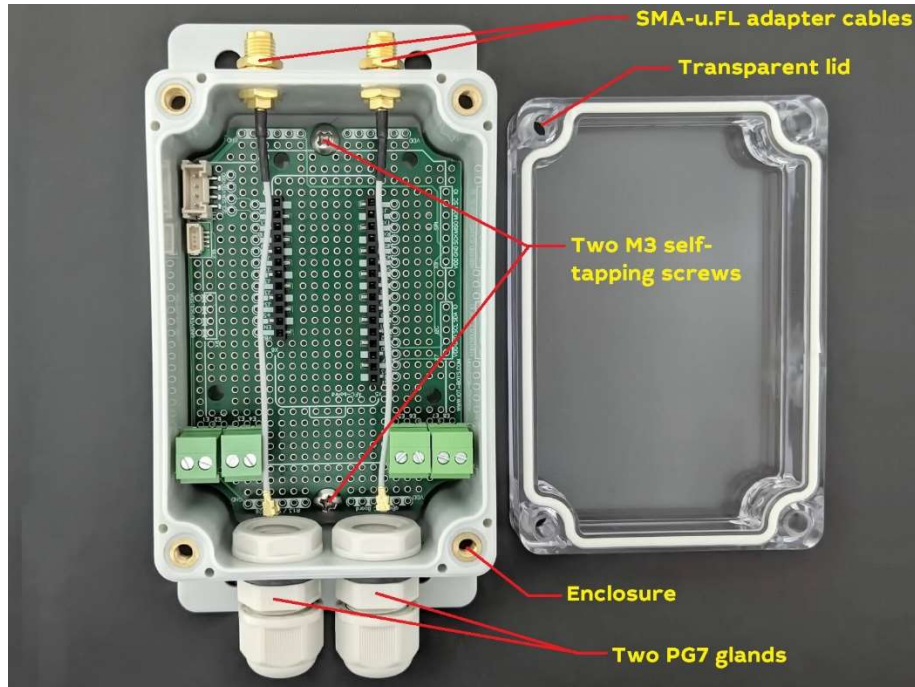

Pic.7. qBox AFC Enclosure Kit parts

External DC voltage from power adapter or solar system could be brought by cable through the one gland inner and another gland gives opportunity to connect external sensors or actuators.

Up to two (depending on kit type) GSM / LTE / WiFi / LoRa / etc. external antennas could be connected to wireless board u.FL PCB connector via SMA to IPEX (u.FL) adapter cables glued into enclosure wall.

Two M3 self-tapping screws securely attach the PCB to the enclosure. Same time board could be easily removed.

Enclosure has enough room to keep with or without stacking header one IOT controller board like Adafruit Feather Compatible (AFC), power supply (DC/DC), OLED display and sensor modules using plain grid proto holes.



Pic.8. qBox AMC Enclosure Kit with Arduino MKR Compatible (AMC) board installed

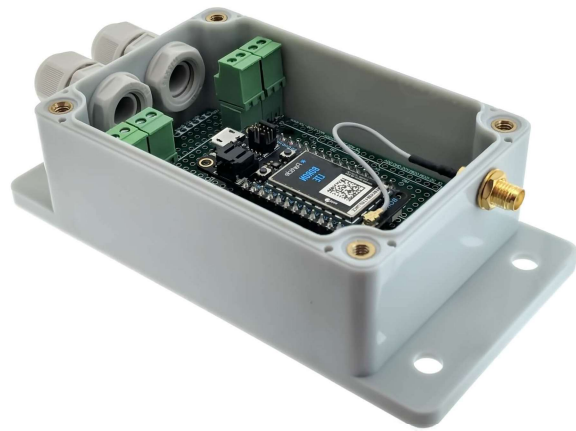

Pic.9. qBox AFC Enclosure Kit with Adafruit Feather Compatible (AFC) board installed

Each board has got four pluggable 3,5mm terminal blocks, one Grove, one 4-pin JST and two low profile pass-through 0,1" SMT AFC interface compatible connectors installed. Several DIP 0.1" I2C and SPI interface connectors could be populated. Two separate power traces for VDD and GND along short PCB sides allow bring the power to sensor boards.

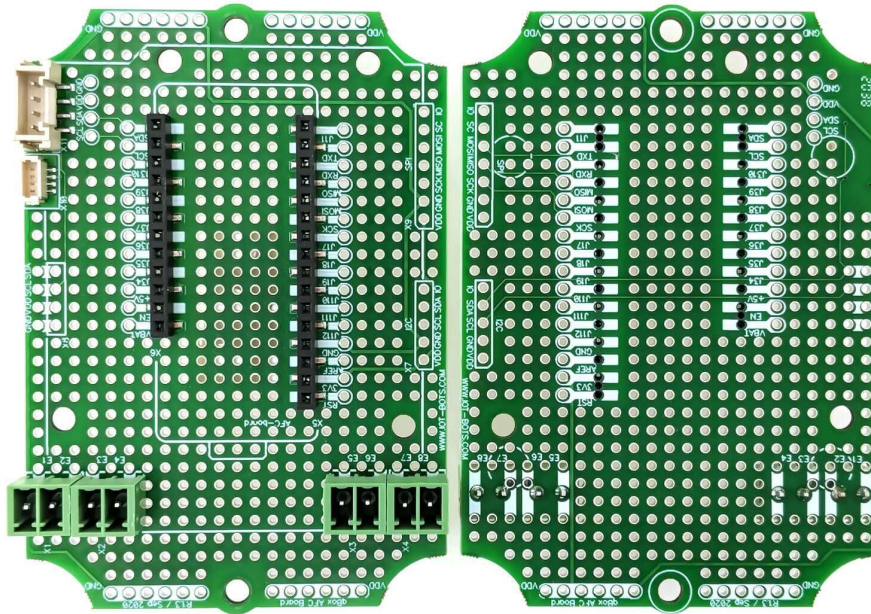

Pic.10. qBox AFC Enclosure Kit PCB common view (Front and Back)

Each AFC connector pin has got a trace with DIP contacts that wires from other modules could be easily soldering.

Connector list:

- X1: External power connection through pluggable 3,5mm terminal block;
- X2...X4: External Input / Output sensor / actuator connections through pluggable 3,5mm terminal blocks;
- X5, X6: IOT board connectors (low profile 0,1" pass through SMT receptacle);
- X7: I2C sensors connector placement (0,1" DIP) with pins: VDD, GND, SCL, SDA, IO;
- X8: OLED I2C connector placement (0,1" DIP) with pins: VDD, GND, SCL, SDA;
- X9: SPI sensors connector placement (0,1" DIP) with pins: VDD, GND, SCK, MISO, MOSI, CS, IO;
- X10: 4 pins JST I2C&Power connector with pins: VDD, GND, SCL, SDA;
- X11: 4 pins Grove compatible I2C&Power connector (2,0 mm SMT) with pins: VDD, GND, SCL, SDA.

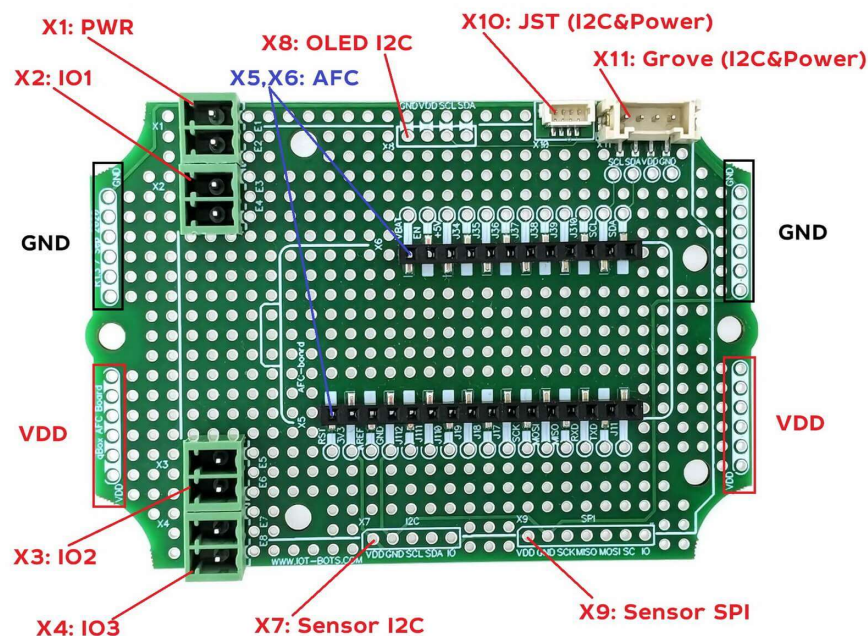

Pic.11. qBox AFC PCB Connectors

There are VDD, GND and I2C connections between appropriate connectors pins and CPU board, so no needs to make these connections separately, just plug a CPU board and I2C sensors to Grove or JST connectors and get solution working. Two separate power traces for VDD and GND along short PCB sides allow bring the power to sensor boards.

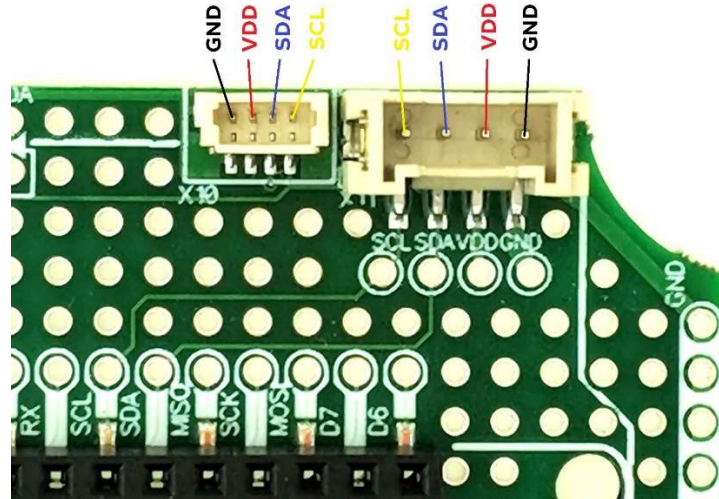

Pic.12. qBox AFC JST and Grove connectors pinout

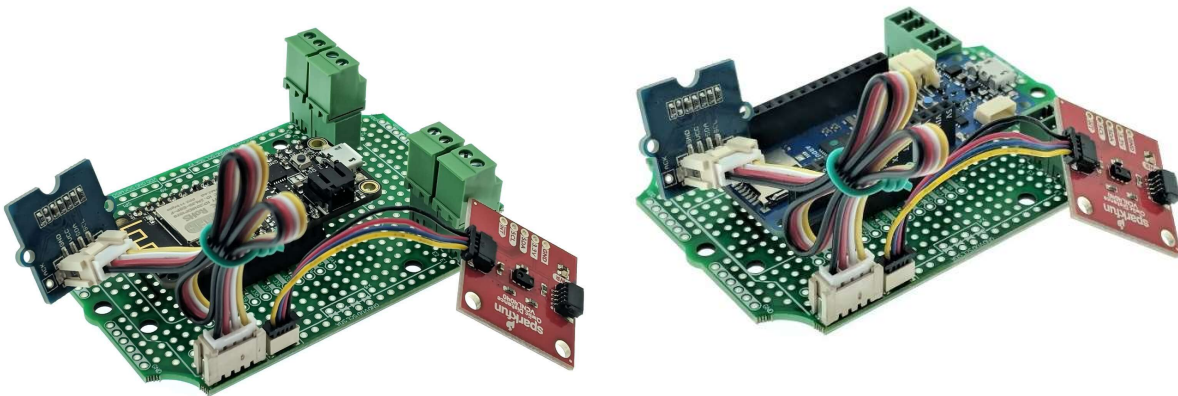

Pic.13. Grove and JST sensors board connection examples

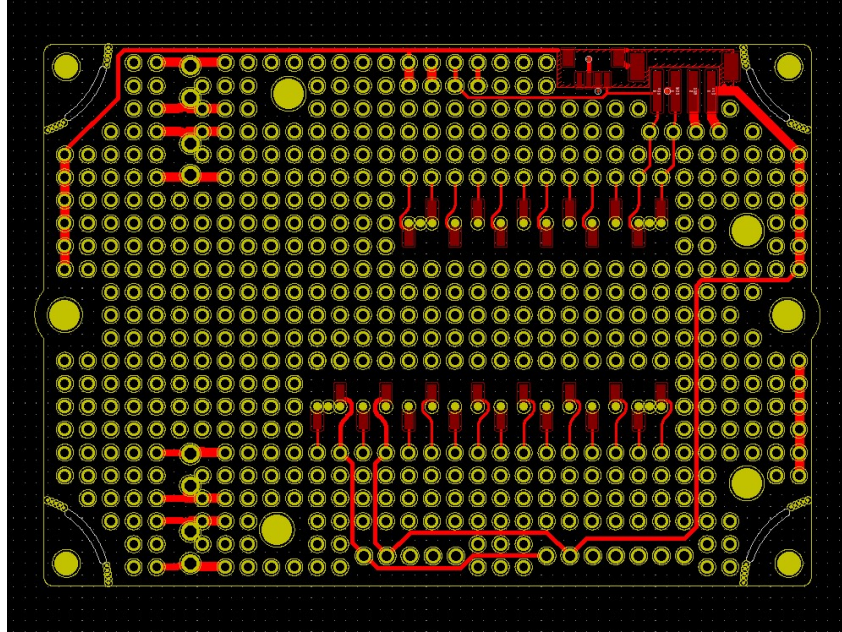

Pic.14. AFC PCB Front Copper traces

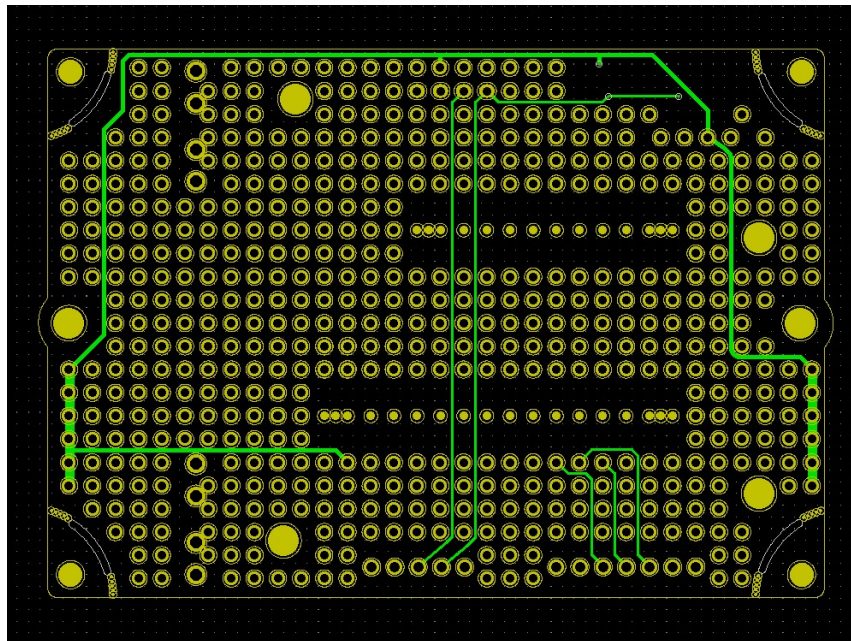

Pic.15. AFC PCB Back Copper traces

IOT board connector pins have power and main interfaces names printed out on PCB. The rest of the pins have conditional names as Jxx.

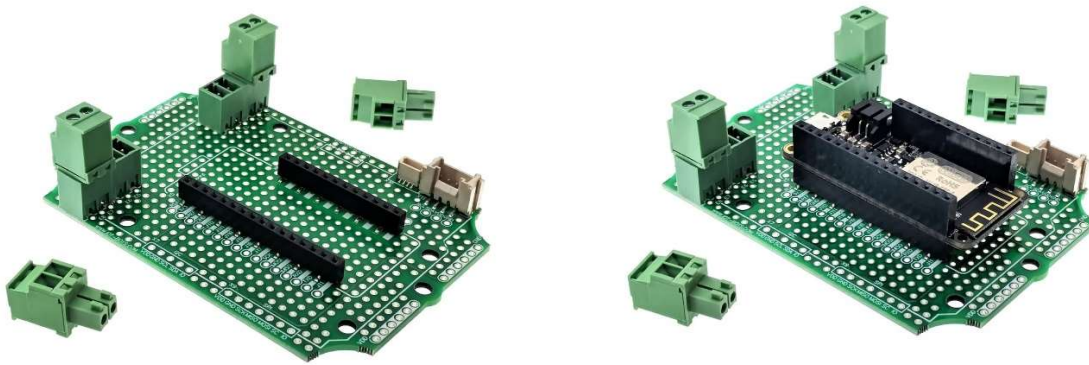

Pic.16. qBox AFC Enclosure Kit PCB

Low profile 0,1" pass through SMT connectors allow to carry Controller board as closer as possible to Kit PCB, saving space above that board to place additional components, like battery, OLED or sensors.

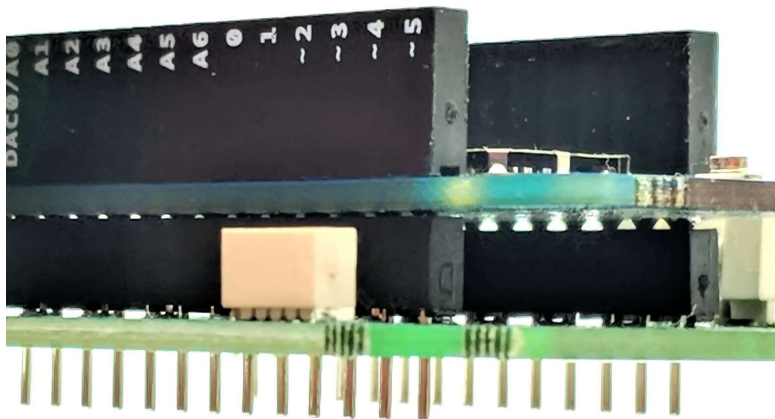

Pic.17. Low profile 0,1" pass through SMT connectors

Transparent lid allows to see internal parts, electronics, LEDs and even display and is able to hold LiPol battery or battery holder to be applied to the internal surface.



Pic. 18. 2xAAA battery holder applied to a transparent lid (assembled view)

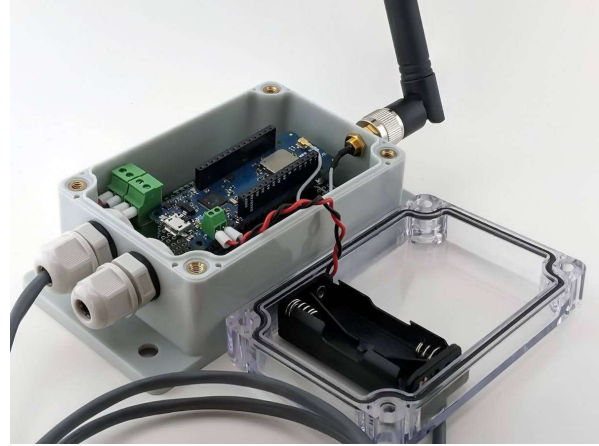

Pic. 19. 2xAAA battery holder applied to a transparent lid (inside view)

Specification

Housing Material: ABS

Water and Dust Proof: IP65

Enclosure Outer Size: 5.42"x2.72"x1.99" (L*W*H)

Enclosure Inner Size: 3.69"x2.42"x1.7" (L*W*H)

Gland model: PG7

Cables with diameters: 0.12-0.25"

PCB size: 3.42"x2.37"

SMA u.FL adapter cables : up to 2

SMA u.FL adapter cable length : 3.15"

qBox AFC Enclosure Kit content

- IP65 waterproof enclosure with two PG7 glands installed and up to two SMA u.FL adapter cables glued (depending on kit type);
- High quality prototyping double sided PCB mounted with two M3 self-tapping screws and connectors installed:

- Adafruit Feather Compatible board female headers set (low profile pass-through 0,1" pitch 1x12 and 1x16 pins connectors);
- Four 3,5mm 2 pins terminal blocks;
- Grove 2mm connector;
- 4-pin JST I2C&Power connector;
- Four 3,5mm 2 pins terminal plugs;
- Packaging bag and shipping box.

Project ideas

Using qBox AFC Enclosure Kits the variety of IOT DIY and POC projects could be done, like LoRa-based soil moisture monitoring project, home WiFi garage door opener, NB-IOT beehive monitoring system, GSM GPS asset tracking solution and many others.



Pic. 20. Adafruit Feather compatible LTE controller POC



Pic. 21. WiFi ESP32 Light Sensor No SMA project



Pic. 22. LTE GPS BG96 tracker with RS485 port (LLS sensor)



Pic. 23. Beehive LoRa monitoring system

Abbreviations

NoNo	Abbreviation	Explanation
1	AFC	Adafruit Feather Compatible
2	AMC	Arduino MKR Compatible

Trademark notice

All referenced brands, product names, service names, and trademarks are the property of their respective owners.

Ordering info

NoNo	Item	SKU
1	qBox AFC DIY IOT Enclosure Kit (No SMA)	IBT-QBX- AFC -0
2	qBox AFC DIY IOT Enclosure Kit (One SMA)	IBT-QBX- AFC -1
3	qBox AFC DIY IOT Enclosure Kit (Two SMAs)	IBT-QBX- AFC -2