

SNT-D20

Aliases (UDLSNTOD200000)

KEMET, SNT, DC Line Filters, Common Mode, 10 uH

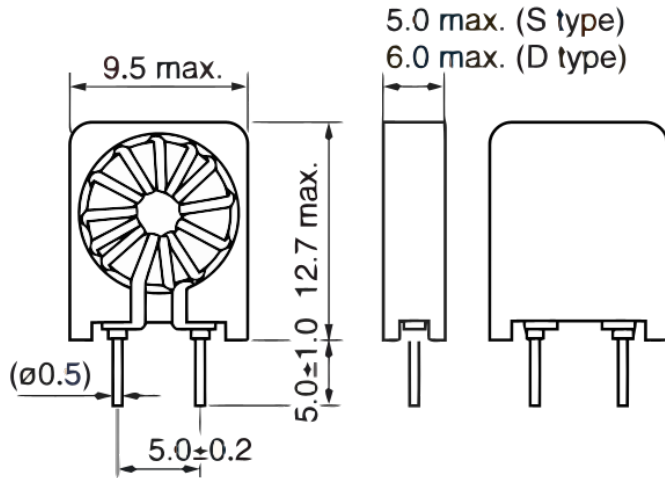

Click [here](#) for the 3D model.

General Information

Series	SNT
Style	Through-Hole
RoHS	Yes

Specifications

Inductance	10 uH
Temperature Range	-20/+60°C
DC Resistance	45 mOhms

Dimensions

L	9.5mm MAX
W	6mm MAX
T	6mm MAX
H	12.7mm MAX
LL	5mm +/-1mm
S	5mm +/-0.2mm

Packaging Specifications

Packaging	Bulk
Packaging Quantity	100
Component Weight	1.2 g

Statements of suitability for certain applications are based on our knowledge of typical operating conditions for such applications, but are not intended to constitute - and we specifically disclaim - any warranty concerning suitability for a specific customer application or use. This information is intended for use only by customers who have the requisite experience and capability to determine the correct products for their application. Any technical advice inferred from this information or otherwise provided by us with reference to the use of our products is given gratis, and we assume no obligation or liability for the advice given or results obtained.