

TA9410E – 25W CW, 50V, 20 - 3000MHz GaN Power Transistor

1.0 Features

- Small signal gain @ 1000MHz: 20dB
- Gain at P3dB @ 1000MHz: 17dB
- P3dB @ 1000MHz: 44dBm
- PAE @ P3dB @ 1000MHz: 57%
- 50V Typical operation
- Operating frequency: 20MHz to 3.0GHz

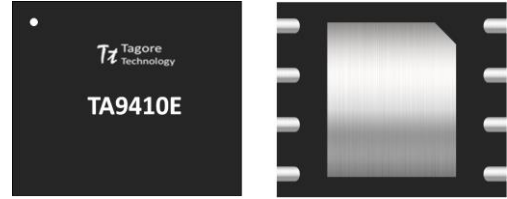

Figure 1.1 Device Image
(8 Pin 6x5x0.8mm QFN Package)

2.0 Applications

- Private mobile radio handsets
- Public safety radios
- Cellular infrastructure
- Military radios



**RoHS/REACH/Halogen Free
Compliance**

3.0 Description

The TA9410E is a broadband GaN power transistor capable of delivering 25W CW from 20MHz to 3.0GHz frequency band. The input and output can be matched for best power and efficiency for the desired band.

The TA9410E is packaged in a compact, low cost Quad Flat No lead (QFN) 5x6x0.8mm, 8 leads plastic package.

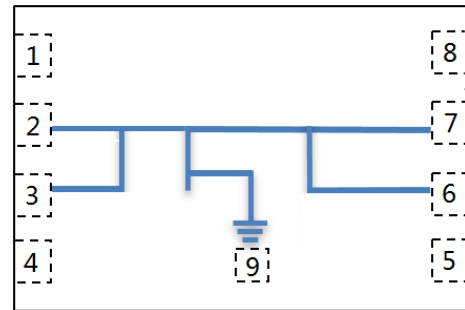

Figure 3.1 Function Block Diagram
(Top View)

4.0 Ordering Information

Table 4.1 Ordering Information

Base Part Number	Package Type	Form	Qty	Reel Diameter	Reel Width	Orderable Part Number
TA9410E	8 Pin 5x6x0.8mm QFN	Tape and Reel	1000	13" (330mm)	18mm	TA9410EMTRPBF
Tuned Evaluation Board, 20 - 525MHz						TA9410E-EVB-A
Tuned Evaluation Board, 20 - 1000MHz						TA9410E-EVB-B

5.0 Pin Description

Table 5.1 Pin Definition

Pin Number	Pin Name	Description
1, 4, 5, 8	NC	No internal connection, Can be grounded
2, 3	V _{GG} & RF _{IN}	Gate voltage and RF input
6, 7	V _{DD} & RF _{OUT}	Drain voltage and RF output
9 ^[1]	Paddle/Slug	Ground

Note: [1] The backside ground slug of the device must be grounded directly to the ground plane through multiple vias to ensure proper operation. Adequate heatsinking required.

6.0 Absolute Maximum Ratings

Table 6.1 Absolute Maximum Ratings @T_A=+25°C Unless Otherwise Specified

Parameter	Symbol	Value	Unit
Electrical Ratings			
Breakdown voltage	V _{DS}	+150	V
Gate voltage	V _{GS}	-10 to +2.0	V
Drain current	I _{DS}	3.0	A
Gate current	I _{GS}	5.2	mA
Power dissipation CW	P _{diss}	28	W
RF input power CW, 20-1000MHz	RF _{IN}	29	dBm
Storage Temperature Range	T _{st}	-55 to +150	°C
Operating Temperature Range	T _{op}	-40 to +85	°C
Maximum Junction Temperature	T _J	+225	°C
Thermal Ratings			
Thermal Resistance (junction-to-case) – Bottom side	R _{θJC}	5.0	°C/W
Soldering Temperature	T _{SOLD}	260	°C
ESD Ratings			
Human Body Model (HBM)	Level 1A	250 to <500	V
Charged Device Model (CDM)	Level C1	250 to <500	V
Moisture Rating			
Moisture Sensitivity Level	MSL	1	-

Attention:

Maximum ratings are absolute ratings. Exposure to absolute maximum rating conditions for extended periods may affect device reliability. Exceeding one or a combination of the absolute maximum ratings may cause permanent and irreversible damage to the device and/or to surrounding circuit.

7.0 RF Electrical Specifications

Table 7.1 Electrical Specifications @ $T_A=+25^{\circ}\text{C}$ Unless Otherwise Specified;

Parameter	Condition	Minimum	Typical	Maximum	Unit
Small Signal Gain	1000MHz		20		dB
Large Signal Gain	$P_{OUT} = 44\text{dBm}$, 1000MHz		17		dB
P3dB	1000MHz		44		dBm
Power Added Efficiency (PAE)	$P_{OUT} = 44\text{dBm}$		57		%
Drain Voltage			50		V
Ruggedness	All phase, $P_{OUT} = 44\text{dBm}$, 1000MHz	VSWR 10:1			

Note: Data taken from 20 - 1000MHz broadband reference design (EVB), $V_D=+50\text{V}$; $I_{DQ}=50\text{mA}$, CW

8.0 Recommended Operating Conditions

Table 8.1 Recommended Operating Conditions

Parameter	Symbol	Minimum	Typical	Maximum	Unit
Drain Voltage	V_{DD}		+50		V
Gate Voltage	V_{GG}	-3.3	-2.75	-2.1	V
Drain Bias Current	I_{DQ}		50		mA
Drain Current	I_{DS} , $P_{out} = 44\text{dBm}$, 1000MHz		880		mA
Power Dissipation CW ^[1]	P_{diss} , $P_{out} = 44\text{dBm}$, 1000MHz		20	25	W
Operating Temperature Range		-40	+25	+85	$^{\circ}\text{C}$

Note: [1] @ $T_C = +85^{\circ}\text{C}$

9.0 Typical Characteristics

9.1 20 - 1000MHz EVB (V_{dd} = 50V, I_{dq} = 50mA, CW)

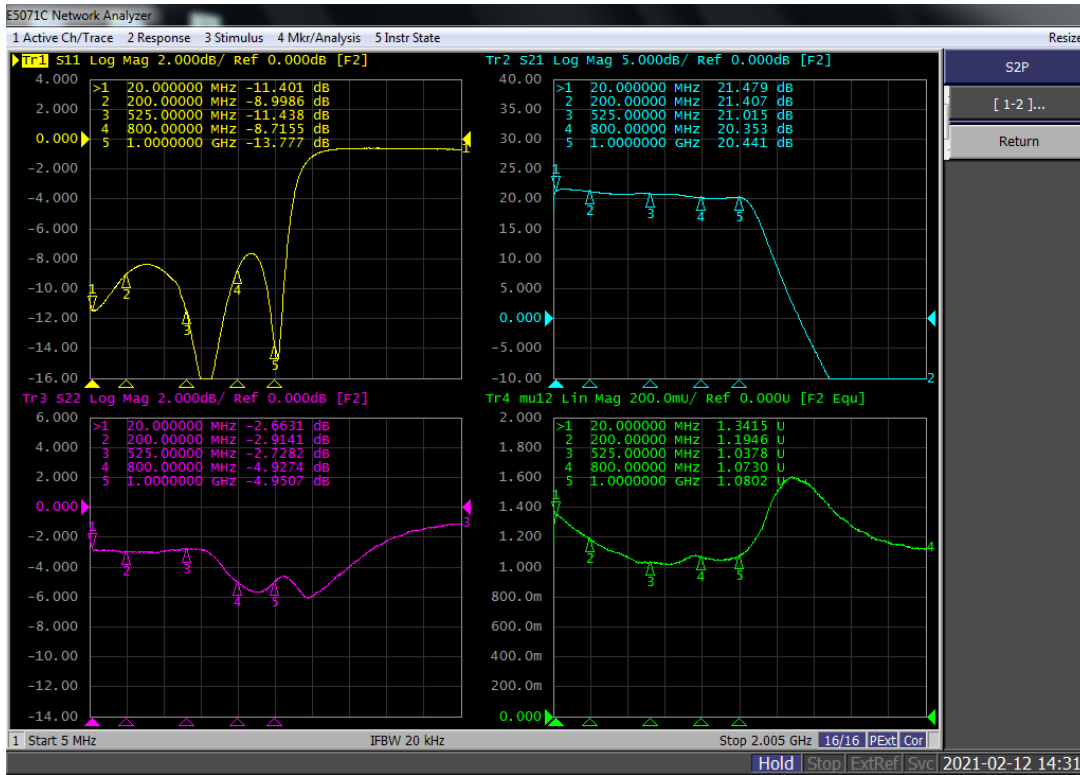

Figure 9.1 Small Signal SParameters (T_A=+25°C)

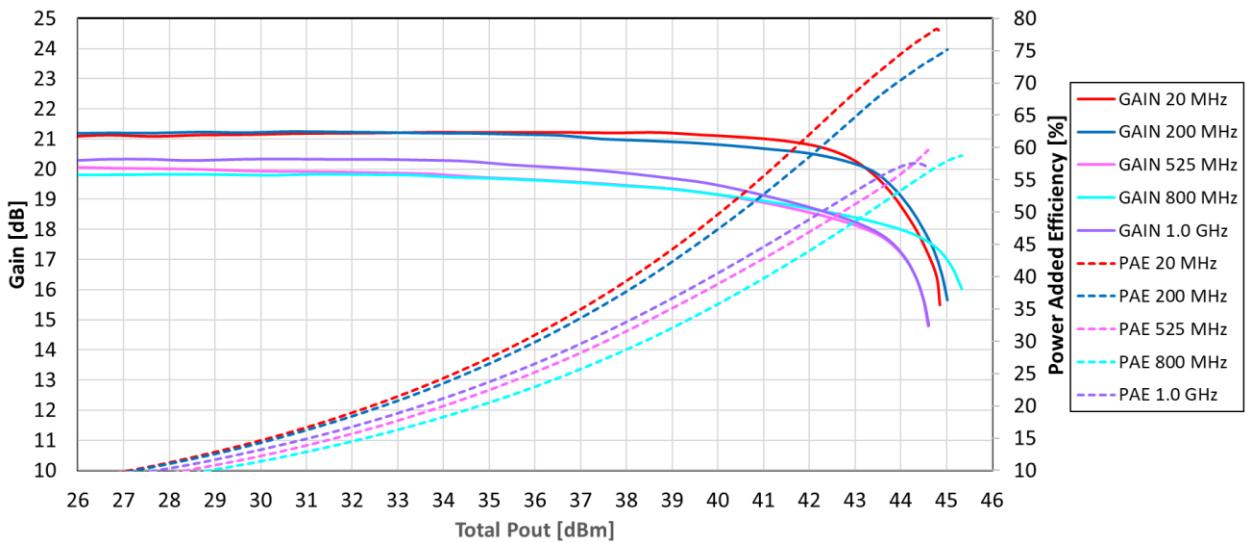

Figure 9.2 Gain and PAE vs P_{OUT} (T_A=+25°C)

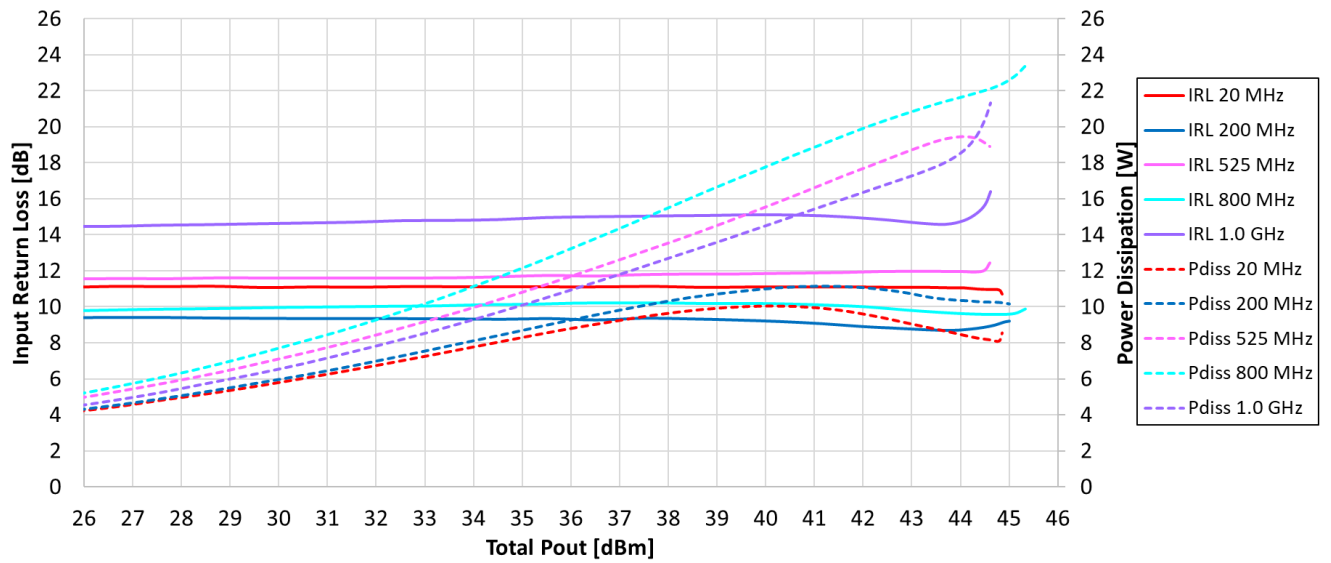

Figure 9.2 IRL and Pdiss vs P_{OUT} (T_A=+25°C)

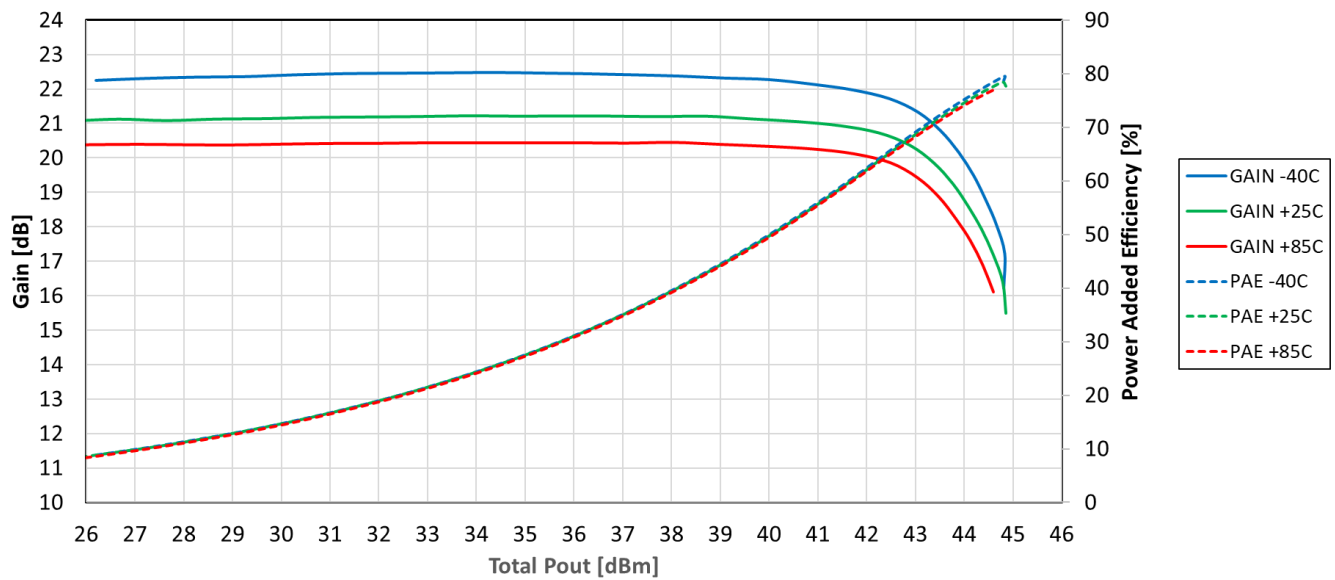

Figure 9.3 Gain and PAE vs P_{OUT} over temperature at 20MHz

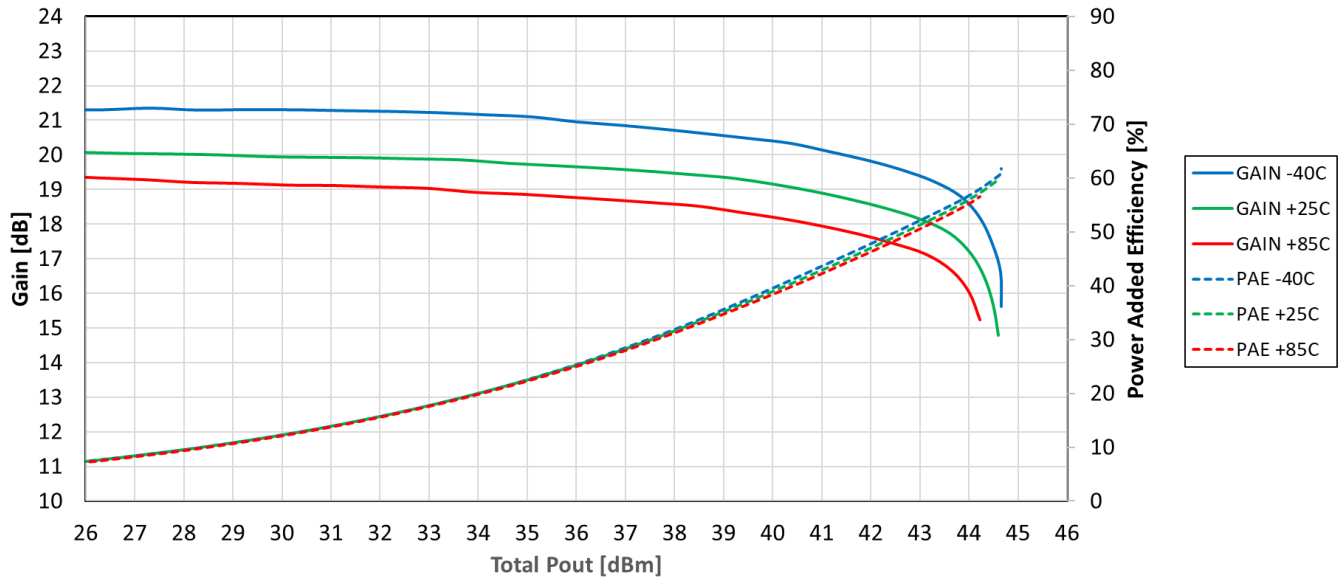

Figure 9.4 Gain and PAE vs P_{OUT} over temperature at 525MHz

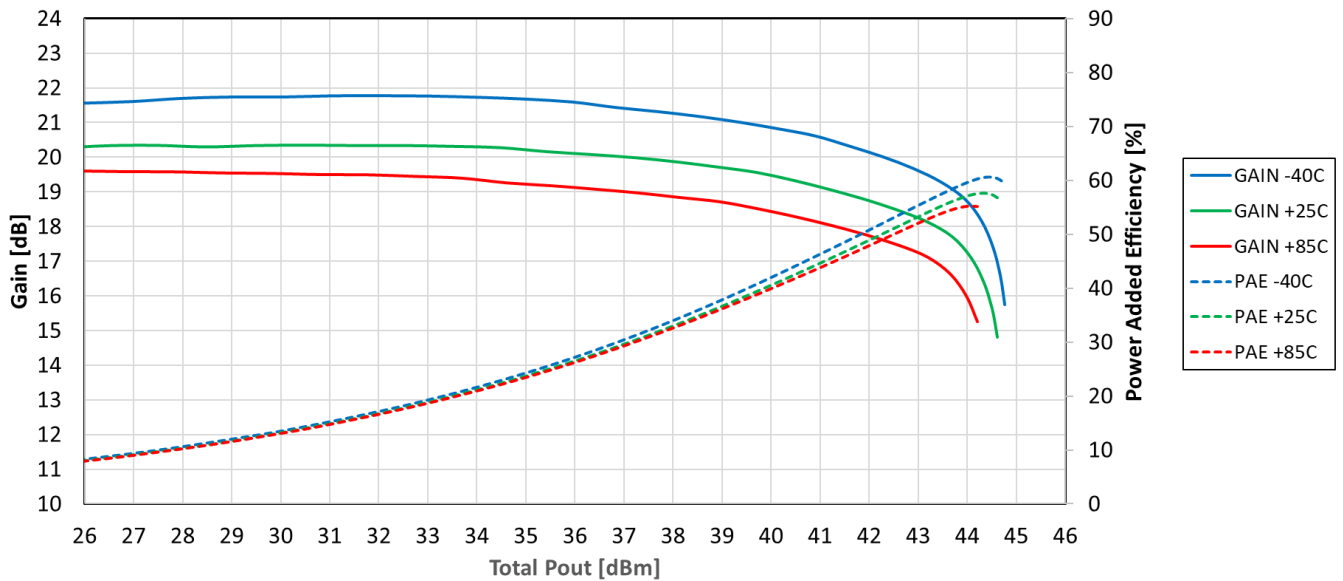

Figure 9.5 Gain and PAE vs P_{OUT} over temperature at 1000MHz

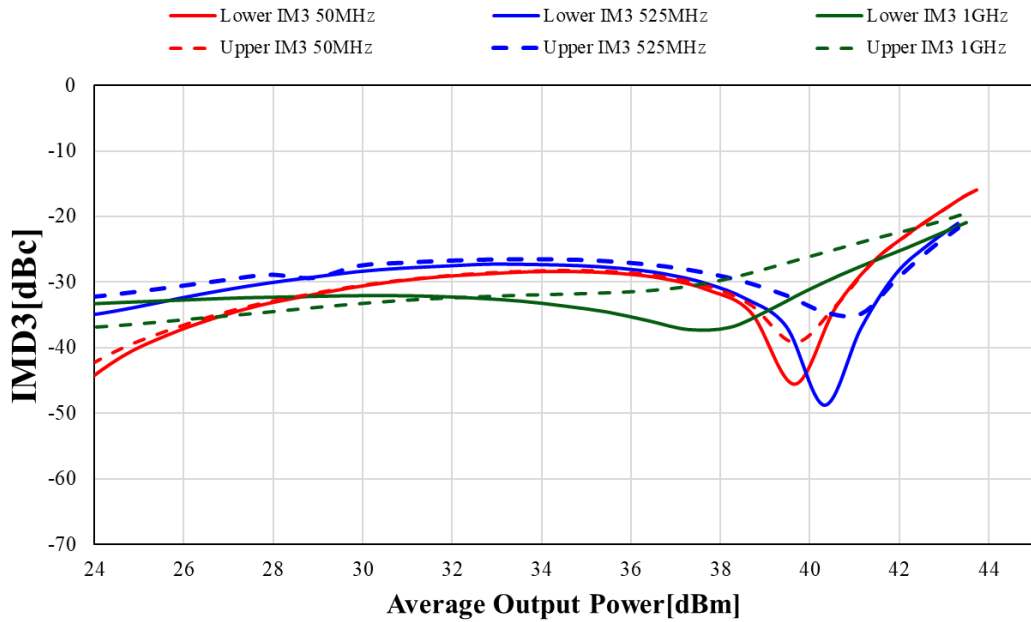

Figure 9.6 IMD3 vs P_{OUT} (V_{dd}=50V, I_{dq} = 50mA, 1MHz tone spacing)

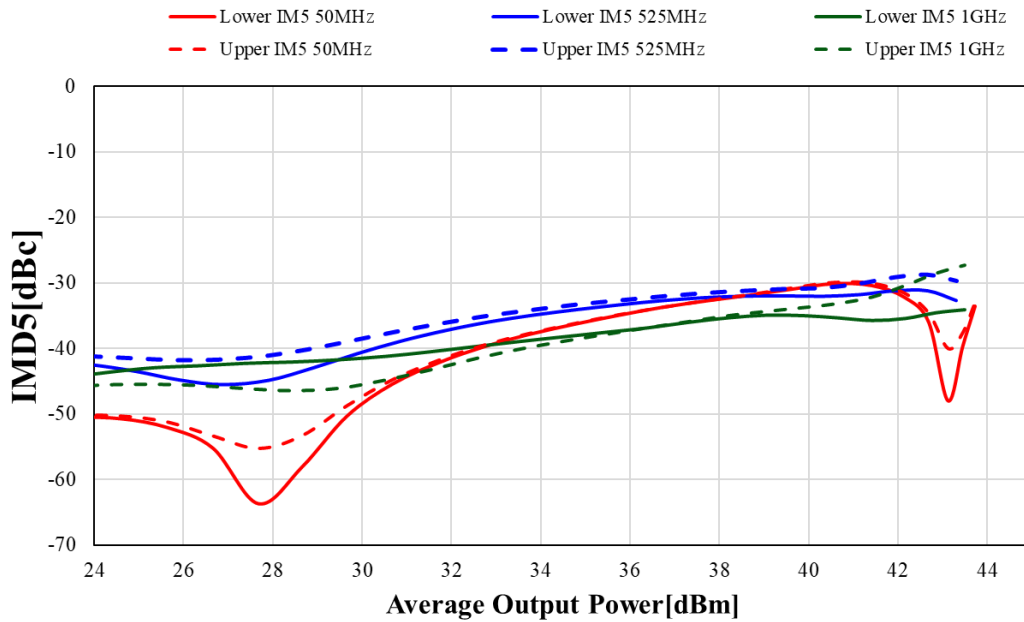

Figure 9.7 IMD5 vs P_{OUT} (V_{dd}=50V, I_{dq} = 50mA, 1MHz tone spacing)

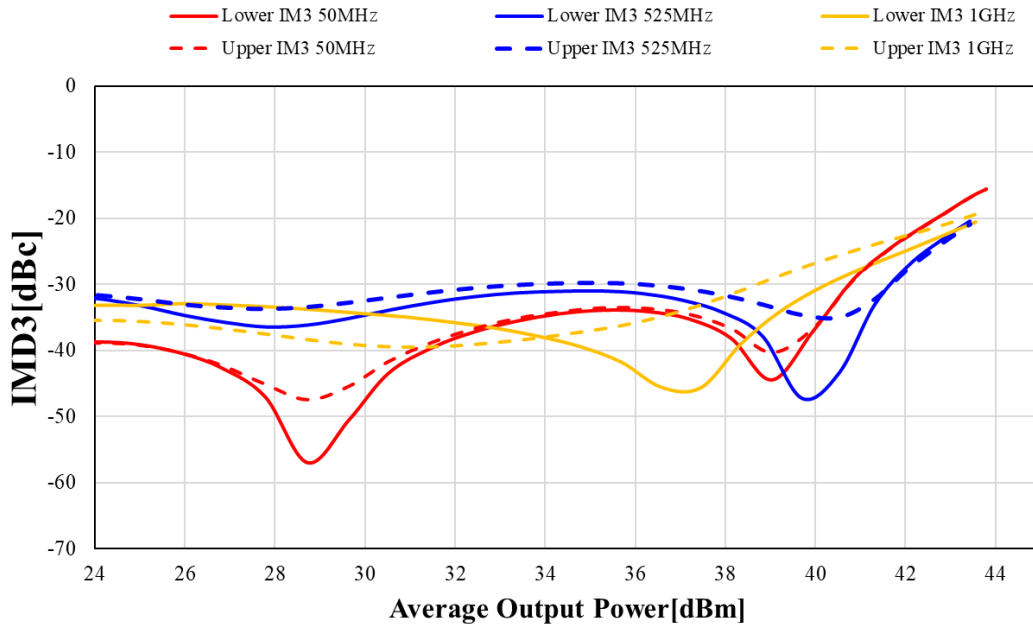

Figure 9.8 IMD3 vs P_{OUT} (V_{dd}=50V, I_{dq} = 75mA, 1MHz tone spacing)

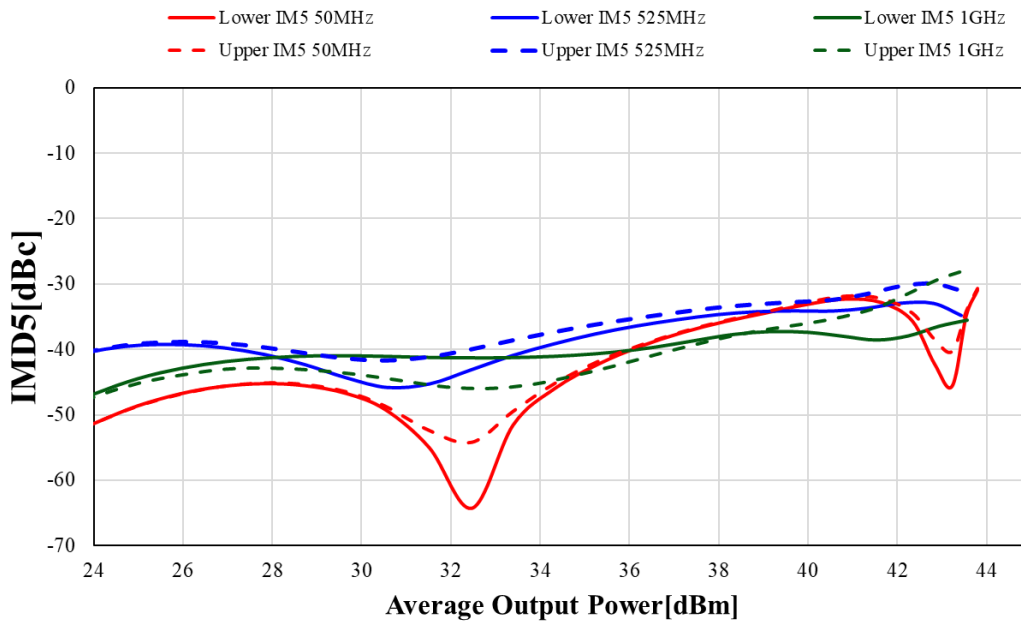

Figure 9.10 IMD5 vs P_{OUT} (V_{dd}=50V, I_{dq} = 75mA, 1MHz tone spacing)

9.2 20 – 525MHz EVB (Vdd = 50V, Idq = 50mA, CW)

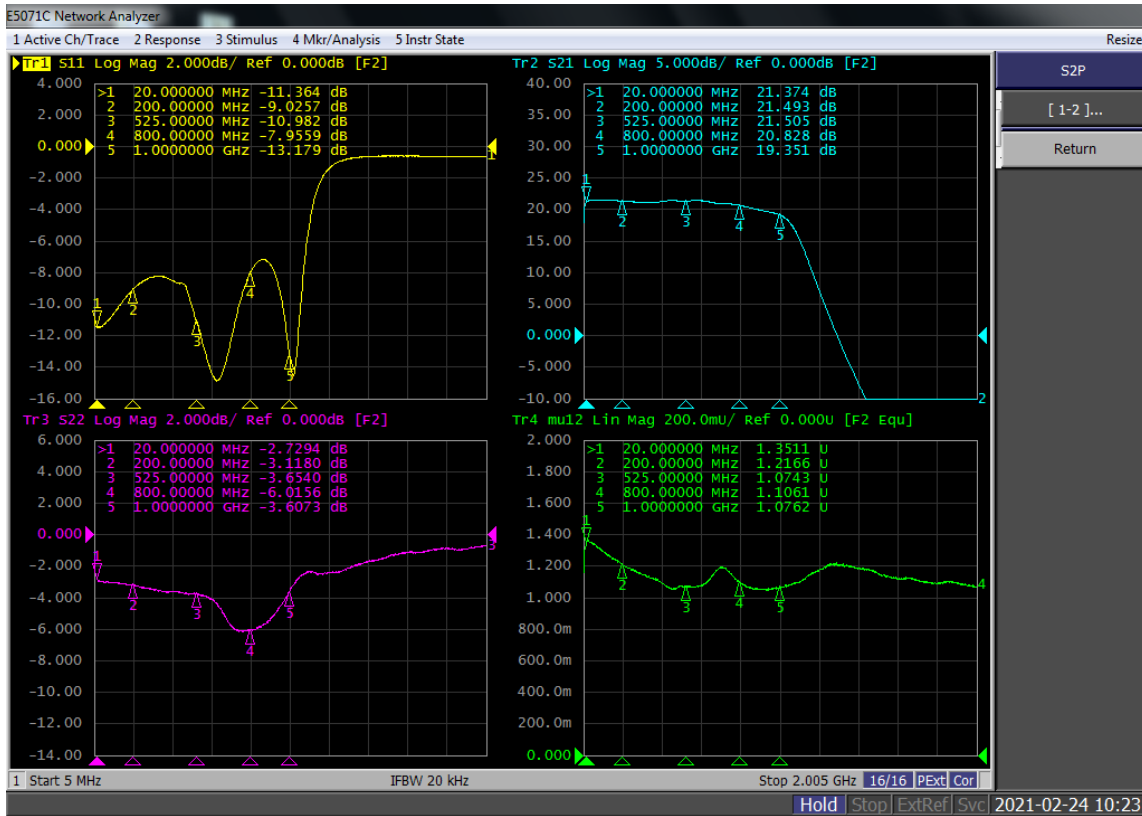

Figure 9.11 Small Signal SParameters (T_A=+25°C)

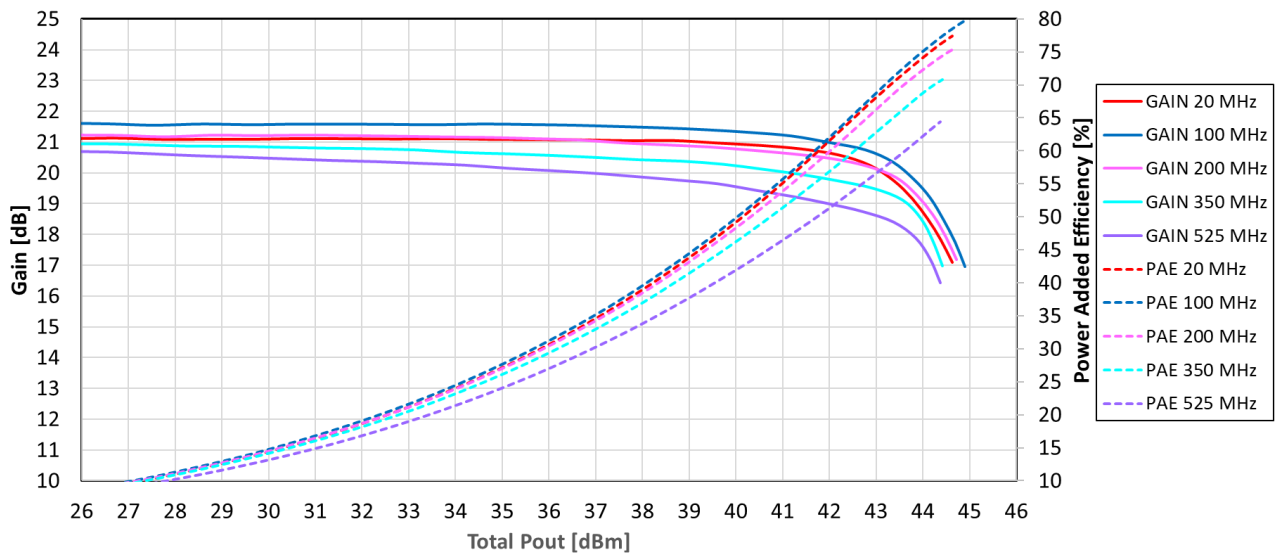

Figure 9.12 Gain and PAE vs P_{OUT} (T_A=+25°C)

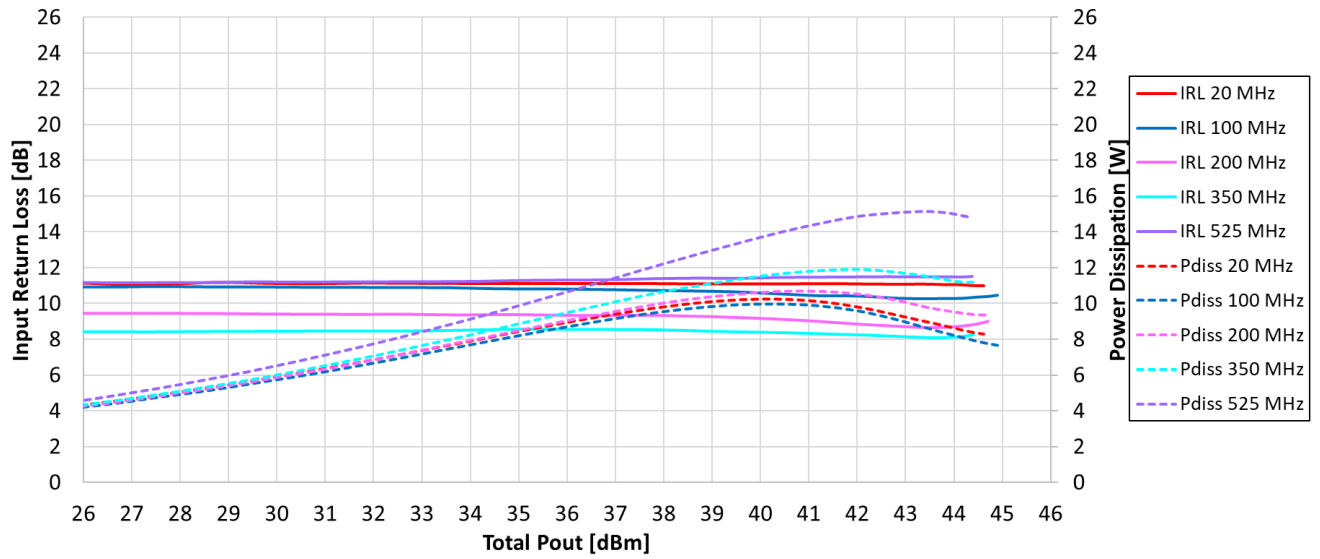

Figure 9.13 IRL and Pdiss vs P_{OUT} (T_A=+25°C)

10.0 Bias and Sequencing

Table 10.1 Bias and Sequencing

Turn ON Device	Turn OFF Device
<ol style="list-style-type: none"> 1. Set V_G to -5V 2. Set V_D to +50V 3. Adjust V_G to reach required I_{DQ} current 4. Apply RF power 	<ol style="list-style-type: none"> 1. Turn RF power off 2. Turn off V_D 3. Turn off V_G

11.0 Evaluation Boards

11.1 20 - 1000MHz EVB

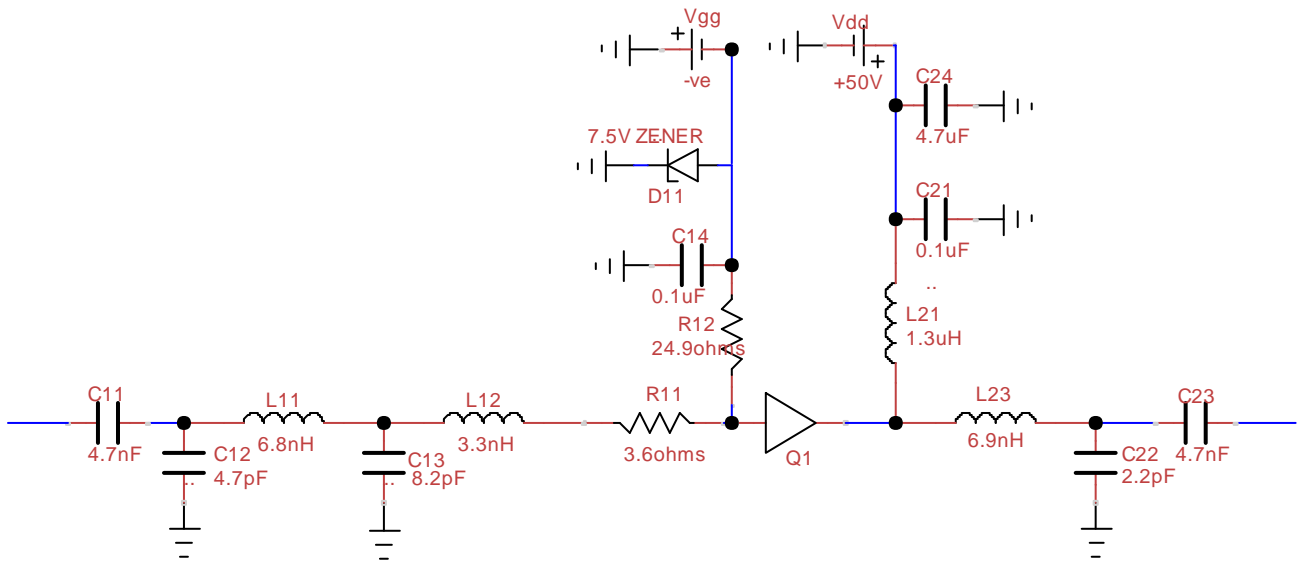
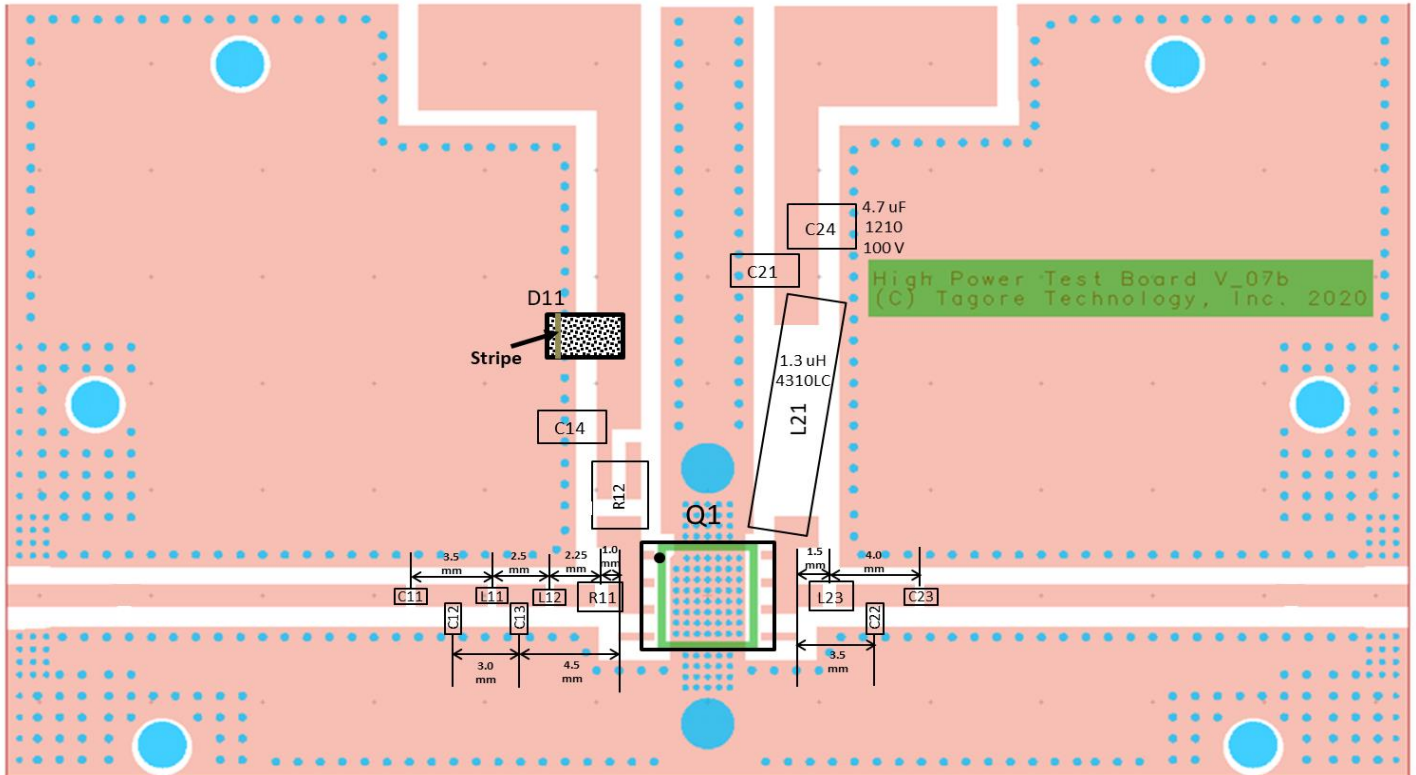

Figure 11.1 Schematic of the 20 - 1000MHz EVB



Note : Pins 4 and 5 can be grounded

Figure 11.2 Board Layout of the 20 - 1000MHz EVB

Table 11.1 BOM of the 20 - 1000MHz EVB

Component ID	Value	Manufacturer	Recommended Part Number
C11, C23	4.7nF, 100V	Murata	GCD188R72A472KA01
C12	4.7pF	ATC	600S4R7BT250XT
L11	6.8nH	Coilcraft	0603HP-6N8XJLC
L12	3.3nH	Coilcraft	0603HP-3N3XJLC
C13	8.2pF	ATC	600S8R2CT250XT
C14, C21	0.1uF, 100V	Murata	GRM31C5C2A104JA01
L21	1.3uH	Coilcraft	4310LC-132KEC
C24	4.7uf, 100V	Murata	GCM32DC72A475KE02
L23	6.9nH	Coilcraft	0807SQ-6N9JLC
C22	2.2pF	ATC	600S2R2BT250XT
R11	3.6Ω, 0.5W	Panasonic	ERJ-P06J3R6V
R12	24.9Ω, 0.75W	Vishay	CRCW121024R9FKEAHP
D11	7.5 V Zener	On Semiconductor	SZMMSZ5236BT 1G
Q1		Tagore Technology	TA9410E
PCB	Rogers RO4350B, 20 mils, 2 oz copper		

11.2 20 - 525MHz EVB

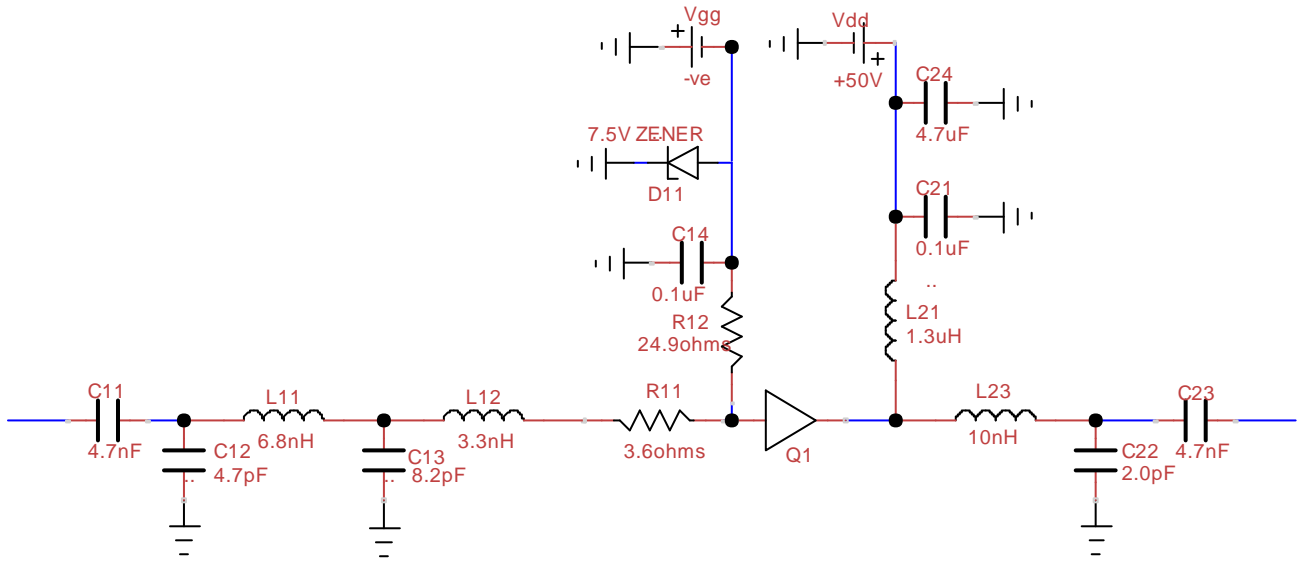
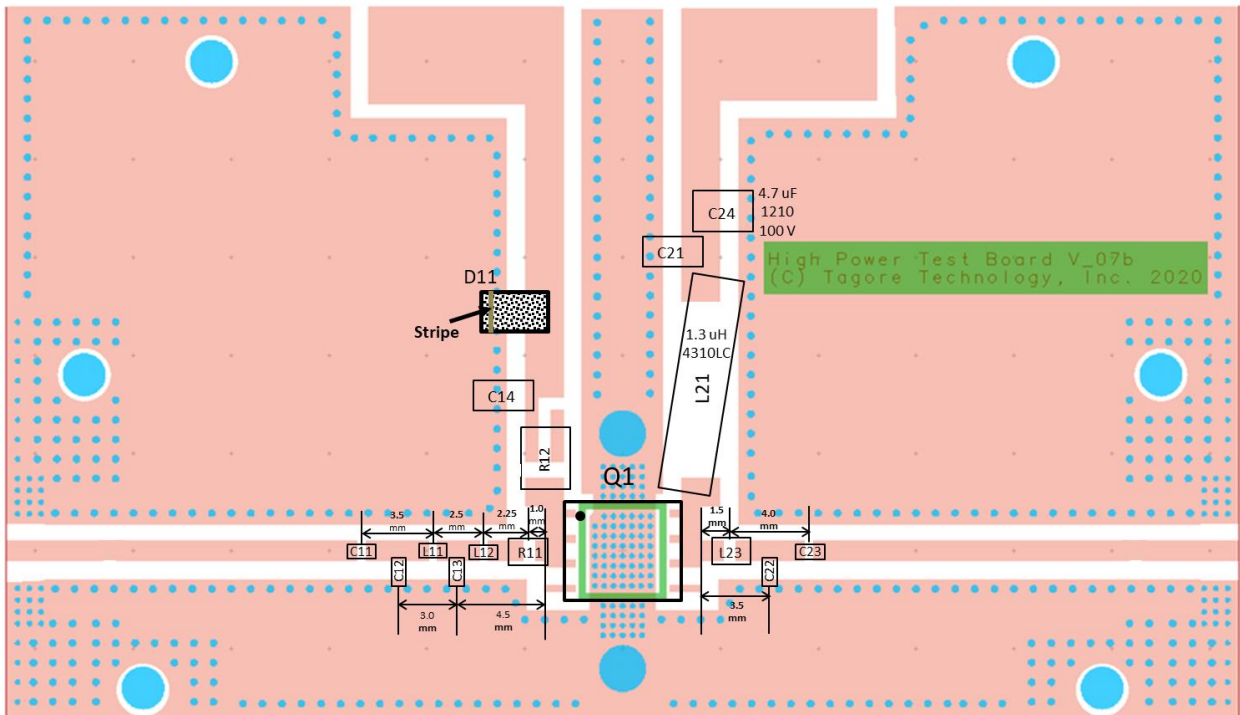

Figure 11.3 Schematic of the 20 - 525MHz EVB



Note : Pins 4 and 5 can be grounded

Figure 11.4 Board Layout of the 20 - 525MHz EVB

Table 11.2 BOM of the 20 - 525MHz EVB

Component ID	Value	Manufacturer	Recommended Part Number
C11, C23	4.7nF, 100V	Murata	GCD188R72A472KA01
C12	4.7pF	ATC	600S4R7BT250XT
L11	6.8nH	Coilcraft	0603HP-6N8XJLC
L12	3.3nH	Coilcraft	0603HP-3N3XJLC
C13	8.2pF	ATC	600S8R2CT250XT
C14, C21	0.1uF, 100V	Murata	GRM31C5C2A104JA01
L21	1.3uH	Coilcraft	4310LC-132KEC
C24	4.7uf, 100V	Murata	GCM32DC72A475KE02
L23	10nH	Coilcraft	0807SQ-10NJLC
C22	2.0pF	ATC	600S2R0BT250XT
R11	3.6Ω, 0.5W	Panasonic	ERJ-P06J3R6V
R12	24.9Ω, 0.75W	Vishay	CRCW121024R9FKEAHP
D11	7.5 V Zener	On Semiconductor	SZMMSZ5236BT 1G
Q1		Tagore Technology	TA9410E
PCB	Rogers RO4350B, 20 mils, 2 oz copper		

12.0 Device Package Information

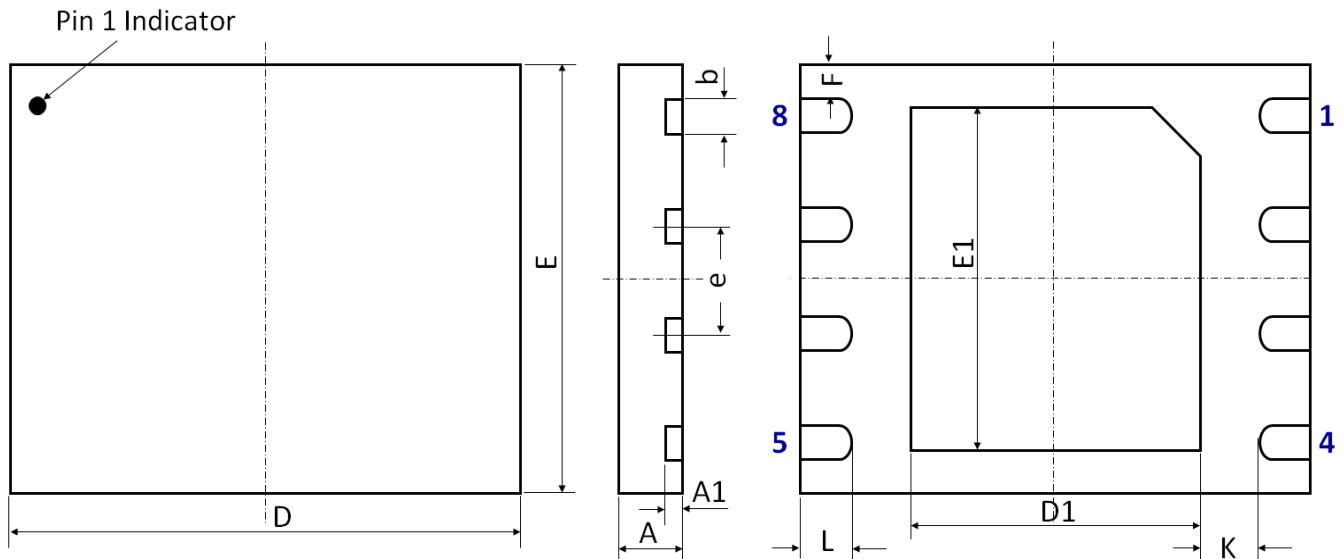

Figure 12.1 Device Package Drawing
(All dimensions are in mm)

Table 12.1 Device Package Dimensions

Dimension (mm)	Value (mm)	Tolerance (mm)	Dimension (mm)	Value (mm)	Tolerance (mm)
A	0.80	±0.05	E	5.00 BSC	±0.05
A1	0.203	±0.02	E1	4.00	±0.05
b	0.40	+0.05/-0.07	F	0.395	±0.05
D	6.00 BSC	±0.05	L	0.60	±0.05
D1	3.40	±0.05	K	0.70	±0.05
e	1.27 BSC	±0.05			

Note: Lead finish: Pure Sn without underlayer; Thickness: 7.5µm ~ 20µm (Typical 10µm ~ 12µm)

Attention:

Please refer to application notes [TN-001](#) and [TN-002](#) at <http://www.tagoretech.com> for PCB and soldering related guidelines.

13.0 PCB Land Design

Guidelines:

- [1] 2-layer PCB is recommended.
- [2] Via diameter is recommended to be 0.3mm to prevent solder wicking inside the vias
- [3] Thermal vias shall only be placed on the center pad
- [4] The maximum via number for the center pad is $7(X) \times 8(Y) = 56$

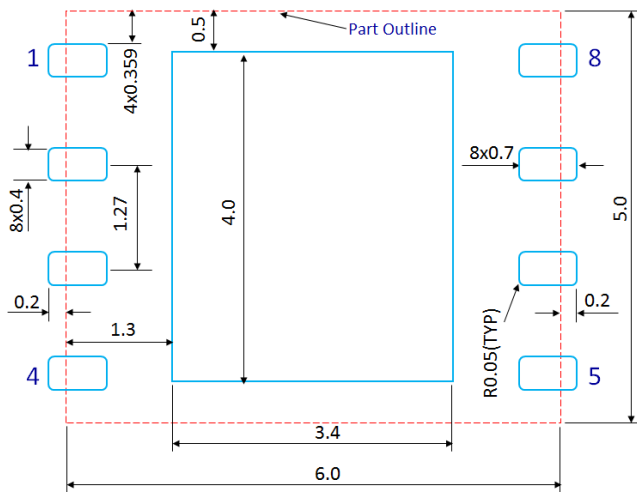

Figure 13.1 PCB Land Pattern
(Dimensions are in mm)

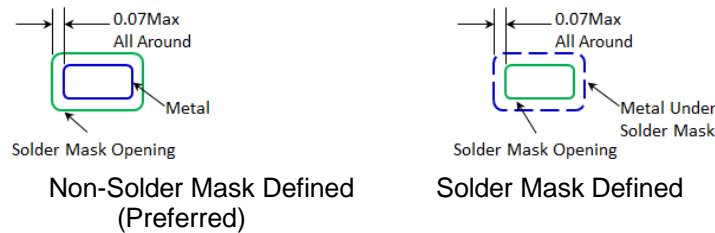

Figure 13.2 Solder Mask Pattern
(Dimensions are in mm)

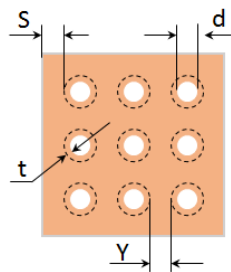

Figure 13.3 Thermal Via Pattern
(Recommended Values: $S \geq 0.15\text{mm}$; $Y \geq 0.20\text{mm}$; $d = 0.3\text{mm}$; Plating Thickness $t = 25\mu\text{m}$ or $50\mu\text{m}$)

14.0 PCB Stencil Design

Guidelines:

[1] Laser-cut, stainless steel stencil is recommended with electro-polished trapezoidal walls to improve the paste release.

[2] Stencil thickness is recommended to be 125µm.

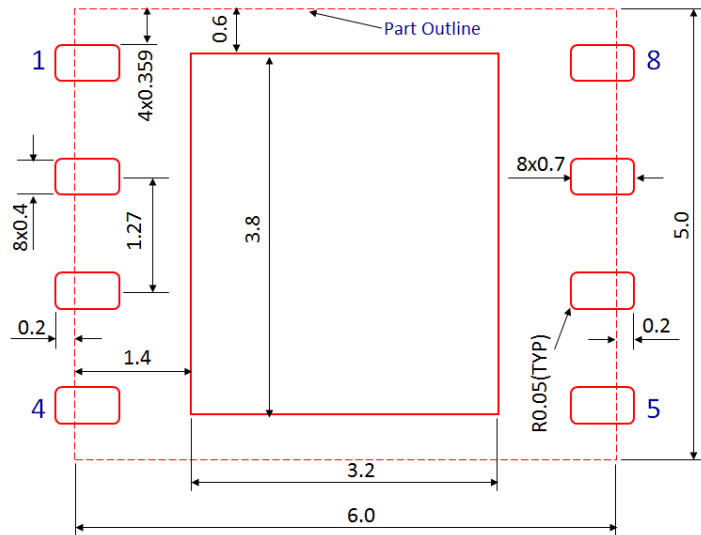

Figure 14.1 Stencil Openings
(Dimensions are in mm)

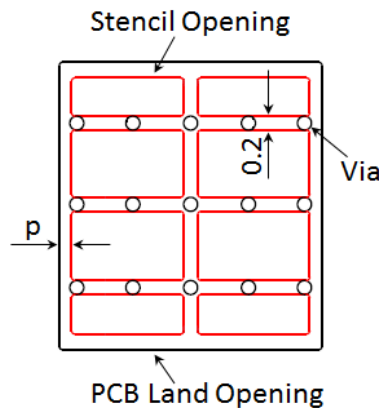

Figure 14.2 Stencil Openings Shall not Cover Via Areas If Possible
(Dimensions are in mm)

15.0 Tape and Reel Information

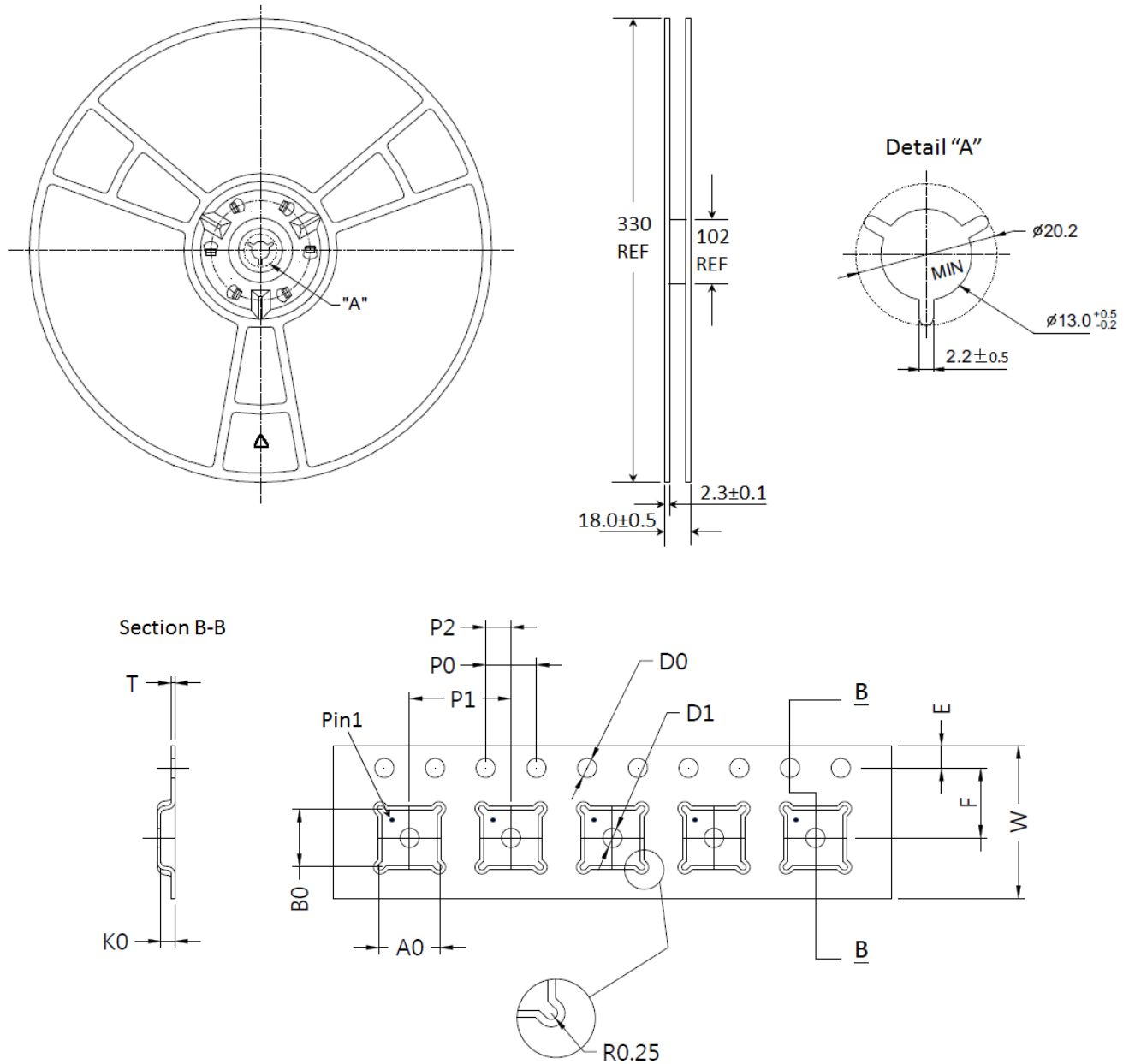

Figure 15.1 Tape and Reel Drawing

Table 15.1 Tape and Reel Dimensions

Dimension (mm)	Value (mm)	Tolerance (mm)	Dimension (mm)	Value (mm)	Tolerance (mm)
A0	6.35	±0.10	K0	1.10	±0.10
B0	5.35	±0.10	P0	4.00	±0.10
D0	1.50	+0.10/-0.00	P1	8.00	±0.10
D1	1.50	+0.10/-0.00	P2	2.00	±0.05
E	1.75	±0.10	T	0.30	±0.05
F	5.50	±0.05	W	12.00	±0.30

Edition Revision 1.0 - 2021-03-18

Published by

Tagore Technology Inc.
5 East College Drive, Suite 200
Arlington Heights, IL 60004, USA

©2020 All Rights Reserved

Legal Disclaimer

The information provided in this document shall in no event be regarded as a guarantee of conditions or characteristics. Tagore Technology assumes no responsibility for the consequences of the use of this information, nor for any infringement of patents or of other rights of third parties which may result from the use of this information. No license is granted by implication or otherwise under any patent or patent rights of Tagore Technology. The specifications mentioned in this document are subject to change without notice.

Information

For further information on technology, delivery terms and conditions and prices, please contact Tagore Technology: support@tagoretech.com.