

PFH05W Evaluation Board Instruction Manual for PFH500F AC-DC Power Modules

BEFORE USING THE POWER SUPPLY UNIT

Be sure to read and understand this instruction manual thoroughly before using this product. Pay attention to all cautions and warnings before using this product. Incorrect usage could lead to an electrical shock, damage to the unit or a fire hazard.

DANGER

Never use this product in locations where flammable gas or ignitable substances are present. There are potential risks of igniting these substances caused by arcing.

WARNING

- Do not touch this product or its internal components while circuit is live, or shortly after shut down. There may be high voltage or high temperature present and you may receive an electric shock or burn.
- While this product is operating, keep your hands and face away from it as you may be injured by an unexpected situation.
- Do not make unauthorized changes to this product, otherwise you may receive an electric shock. It will also void the product warranty.
- Do not drop or insert anything into the product. It might lead to a failure, fire or electric shock.
- Do not use this product if abnormal conditions such as emission of smoke and/or abnormal smell, etc... are present. It might lead to fire and/or electric shock. In such cases, please contact TDK-Lambda. Do not attempt to repair by yourself, as it is dangerous for the user.
- Do not operate these products in the presence of condensation. It might lead to fire or electric shock.

CAUTION

- This power supply is designed and manufactured for use within an end product such that it is accessible only to trained SERVICE ENGINEERS.
- Confirm that the connections to input/output terminals, and signal terminals are correct as specified in this instruction manual before turning on the power.
- Input voltage, Output current, Output power, ambient temperature, case temperature, and ambient humidity should be kept within the specifications, otherwise the product may be damaged.
- Do not operate or store this product in an environment where condensation can occur. Waterproof treatment or special storage and handling is necessary.
- The equipment has been evaluated for use in a Pollution Degree 2 environment.
- Do not use this product in environment with a strong electromagnetic field, corrosive gas or conductive substances.
- For applications, which require very high reliability, such as nuclear related equipment, medical equipment, traffic control equipment, etc., it is necessary to provide a fail-safe mechanism in the end equipment.
- Do not inject abnormal voltages into the output terminals or signal terminals of this product. The injection of reverse voltage or over voltage exceeding nominal output voltage into these terminals can damage the internal components of the product.
- Never operate the product under over-current or short circuit conditions. Failure or other damage may occur.
- The output voltage of this power supply unit is considered to be a hazardous energy level (The voltage is 2V or more and the electric power is 240W or more). It must not be made accessible to users. Protection must be provided for Service Engineers against indirect contact with the output terminals and/or to prevent tools being dropped across them. While working on this product, the AC input power must be switched off, and the input, output, +VBus, and -VBus terminal voltages should be at a safe level.
- The application circuits and their parameters are for reference only. Be sure to verify effectiveness of these circuits and their parameters before finalizing the circuit design.
- Use a Fast-Blow external fuse to each module to ensure safe operation and compliance with the safety standards to which it is approved. The recommended input fuse rating within the instructions is as follows: 10A, 250V fast acting fuse. The breaking capacity and voltage rating of this fuse may be subject to the end use application.

⚠ CAUTION

- This information in this document is subject to change without prior notice. Please refer to the latest version of the data sheet, etc., for the most up-to date specifications of the product.
- No part of this document may be copied or reproduced in any form without prior written consent TDK-Lambda.



PFH Evaluation Kit with PFH05W Evaluation Test Board

Reference Documents:

- 1.) [PFH Instruction Manual](#)
- 2.) [PFH PMBus Specification](#) Customer Release
- 3.) PFH500F-## Evaluation Report (## - denotes output voltage of PFH500F AC-DC module: "28" = 28 Vdc)
- 4.) PFH [GUI](#) Interface

Table of Contents

BEFORE USING THE POWER SUPPLY UNIT	1
1.0 Ordering Information.....	4
1.1 Evaluation Kit Description.....	4
2.0 Getting Started.....	5
2.1 Test Equipment.....	5
2.2 Test Setup.....	6
2.3 Test Points.....	8
2.4 PMBus and Remote On/Off Functions.....	9
2.5 Setting the PMBus Address.....	10
2.6 Turning PFH Module On/Off.....	11
3.0 Electrical Schematic Drawing.....	12
4.0 Bill of Material.....	13
5.0 Board Files.....	14

1.0 Ordering Information

Series	Rated Output Voltage		Option Code		Evaluation Kit		# of Modules
PFH05W	##	-	1*0	-	EVK	-	S1
	12V 28V 48V		100 – Non Droop 1D0 – Droop Mode for Current Share				Single

1.1 Evaluation Kit Description

Evaluation Kit Part Number	PFH500F Module Installed	Rated Input	Rated Output Voltage (Vdc)	Rated Output Current (A)	Droop Mode **
PFH05W12-100-EVK-S1	PFH500F-12-100-R	85-265 Vac 50/60 Hz	12	42.0	No
PFH05W12-1D0-EVK-S1	PFH500F-12-1D0-R		12	42.0	Yes
PFH05W28-100-EVK-S1	PFH500F-28-100-R		28	18.0	No
PFH05W28-1D0-EVK-S1	PFH500F-28-1D0-R		28	18.0	Yes
PFH05W48-100-EVK-S1	PFH500F-48-100-R		48	10.5	No
PFH05W48-1D0-EVK-S1	PFH500F-48-1D0-R		48	10.5	Yes

* Consult sales for Evaluation Kits that offer 400Hz input line frequency operation.

** For simplified paralleling to support higher power or redundant applications, use Droop Mode.

2.0 Getting Started

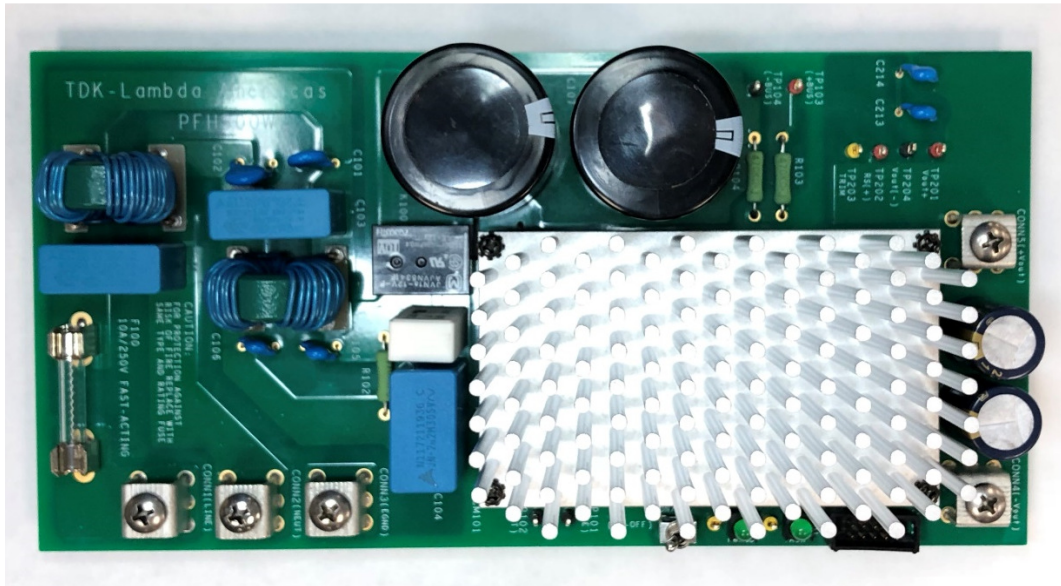

PFH05W##-100-EVK-S1 & PFH05W##-1D0-EVK-S1 Evaluation Boards

NOTE: ## - Denotes output voltage of PFH modules (e.g. “28” for 28Vdc)

2.1 Test Equipment

- 1.) **AC Voltage Source:** Capable of single-phase output, AC voltage range $85 V_{AC} - 265 V_{AC}$, 47 Hz - 63 Hz, adjustable. AC Source should be adequately sized to support the PFH module's operation.
- 2.) **DC Multimeter:** Capable of 0V to 500V input range.
- 3.) **Output Load:** DC load capable of $60 V_{DC}$ or greater, DC Load current up to 42A or greater (12V/42A, 28V/18A, or 48V/10.5A), and 500 W or greater, with display such as load current and load power.
- 4.) **Fan:** Some airflow is required to be directed across the mounted heatsink of the PFH module.

2.2 Test Setup

- 1.) Electrical Input Connections:
- | | |
|---------------|--|
| CONN1: | LINE , Input Line Connection |
| CONN2: | NEUT , Input Neutral Connection |
| CONN3: | EGND , Earth Ground Connection |

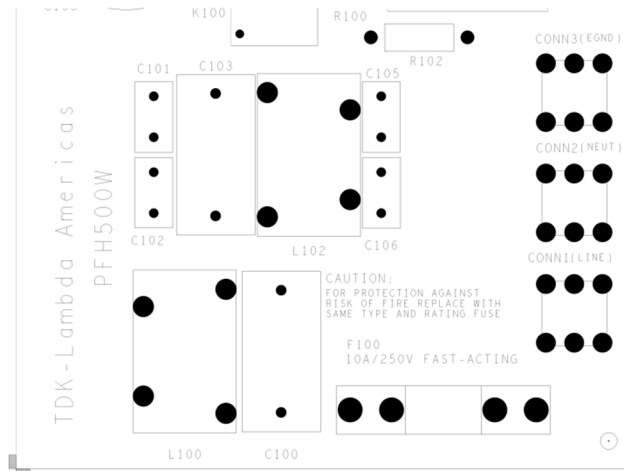

NOTE: Refer to the PFH Datasheet for specific module’s AC Input Current requirement when sizing wire gauge and cable length.

- 2.) Electrical Output Connection:
- | | |
|--------------|--|
| CONN5 | +Vout , Output Load Connections
(Red Cable) |
| CONN4 | -Vout , Output Load Return Connections
(Black Cable) |

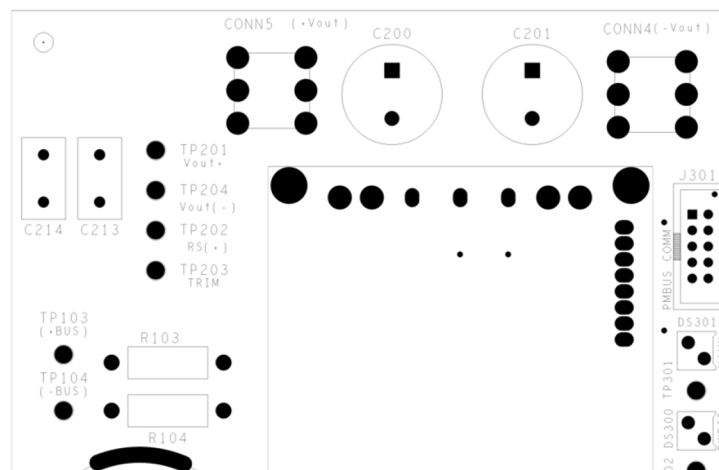

⚠ WARNING

Make sure ALL input and output cables are de-energized before making electrical connections to the Evaluation Test Board

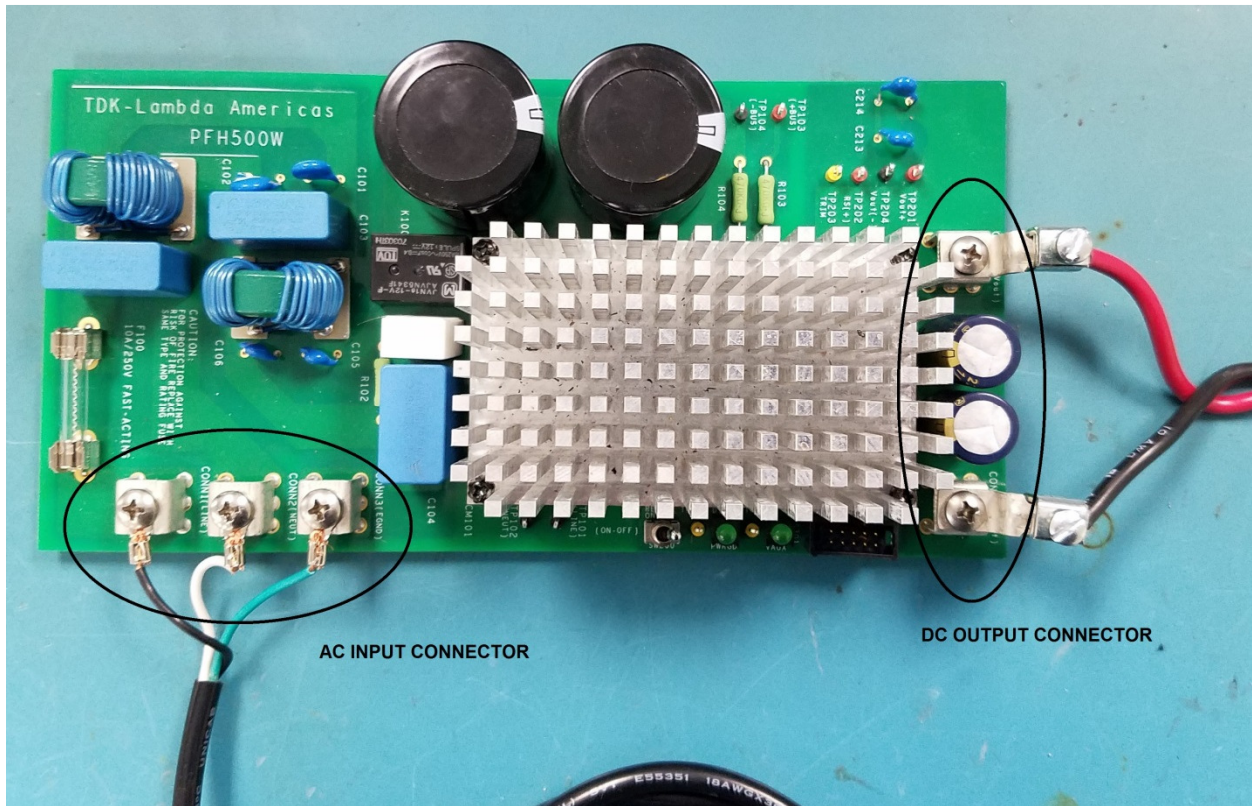

AC INPUT CONNECTOR

DC OUTPUT CONNECTOR

2.3 Test Points

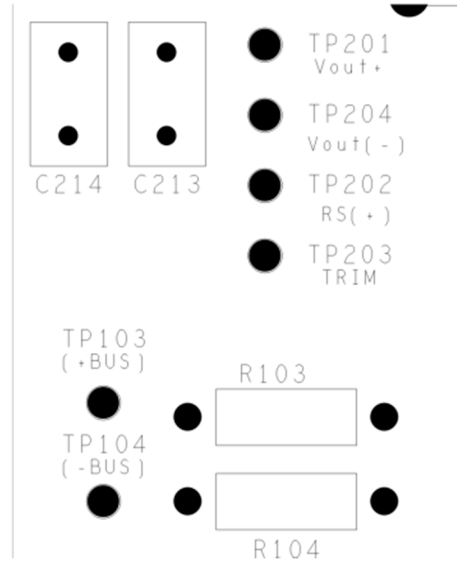

- | | | |
|----------------------------|-------|---|
| 1.) Secondary Test Points: | TP201 | Vout+ , Monitor Output Voltage |
| | TP204 | Vout(-) , Monitor Output Voltage return |
| | TP202 | RS(+) , Output Remote Sense (+) connection |
| | TP203 | TRIM , Trim Test connection |

⚠ WARNING HAZARDOUS VOLTAGE

- | | | |
|--------------------------|-------|-------------------------------------|
| 2.) Primary Test Points: | TP103 | +BUS , Monitor 400Vdc |
| | TP104 | -BUS , Monitor 400Vdc return |

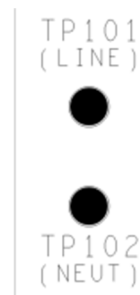

- | | |
|-------|--|
| TP101 | LINE , Monitor AC Line Input |
| TP102 | NEUT , Monitor AC Neutral Input |

2.4 PMBus and Remote On/Off Functions

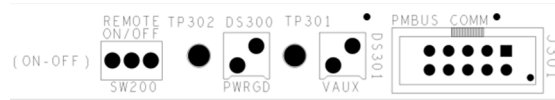

1.) PMBus Connections (J301)

Pin #:	Description:
1	Not Used
2	Not Used
3	Not Used
4	Not Used
5	USB 3.3Vdc ¹
6	SGND
7	Not Used
8	PMBus Alert
9	PMBus Clock
10	PMBus Data

NOTE:

1. 3.3Vdc is supplies by the interface module

To communicate with the PFH module via PMBus, use the Texas Instruments Interface Adapter EVM (P/N#: USB-TO-GPIO). This adapter is available through normal distribution channels.

⚠ WARNING When AC voltage is applied to the Evaluation Test Board the 450V bulk capacitors ARE energized at ALL time

- | | | | | | |
|-------------------------------|---|-------|---------------------------|-------|---------------------------|
| 2.) Remote On/Off (SW200) | SW200 , Will either turn the module On or put it into Standby | | | | |
| 3.) Auxiliary Voltage (DS301) | DS301 , The LED will Turn-On when the 450Vdc bulk capacitors are energized above 70Vdc | | | | |
| 4.) Power Good (DS300) | DS300 , The LED will Turn-On once the module's output has been Turned-On | | | | |
| 5.) Test Points | <table border="0" style="margin-left: 20px;"> <tr> <td style="padding-right: 20px;">TP301</td> <td>Monitor Auxiliary Voltage</td> </tr> <tr> <td>TP302</td> <td>Monitor Power Good Signal</td> </tr> </table> | TP301 | Monitor Auxiliary Voltage | TP302 | Monitor Power Good Signal |
| TP301 | Monitor Auxiliary Voltage | | | | |
| TP302 | Monitor Power Good Signal | | | | |

2.5 Setting the PMBus Address

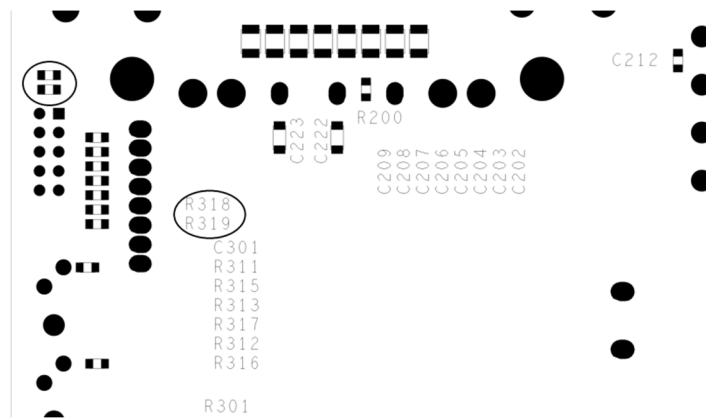

- The PMBus address setting on the Evaluation Test Board comes with the Factory default setting, Address: 0x19 (Hex) (R318 is not populated & R319 is populated with 1.00K)

2.6 Turning PFH Module On/Off

- 1.) Before applying AC voltage to the module make sure,
 - a. The surface under the test fixture is a non-conductive surface
 - b. Securely connect Input and Output cables to the test board
 - c. Securely connect all monitoring devices to test board

⚠ WARNING When AC voltage is applied to the Evaluation Test Board the 450V bulk capacitors ARE energized at ALL time

- 2.) Apply AC input voltage to test fixture
 - a. AC input voltage range 100Vac – 265Vac
 - b. AC input voltage range < 100Vac, output load is de-rated 6.7W/V
 - c. Once AC input voltage is applied, Auxiliary Voltage LED (DS301) will Turn-On
- 3.) Turning On PFH module can be accomplished 1 of 2 ways,
 - i. Remote On/Off
 - ii. PMBus
 - a. The method chosen to turn On PFH has to be the **SAME** method to turn Off PFH
 - i. Example: If Remote On/Off turns On PFH, then PMBus cannot turn it Off, only Remote On/Off can turn Off PFH.
 - b. Method 1: Toggle Remote On/Off,
 - I. Remote On/Off switch (SW200) On – Will turn PFH On
 - II. Remote On/Off switch (SW200) Off – Will turn PFH Off.
 - c. Method 2: PMBus,
 - I. Write CMD 0x01, Byte 0x80 – Turns PFH On
 - II. Write CMD 0x01, Byte 0x00 – Turn PFH Off
 - d. Once PFH is turned On, Power Good LED (DS300) will turn On
 - e. When PFH is turned Off, Power Good LED (DS300) will turn Off

3.0 Electrical Schematic Drawing

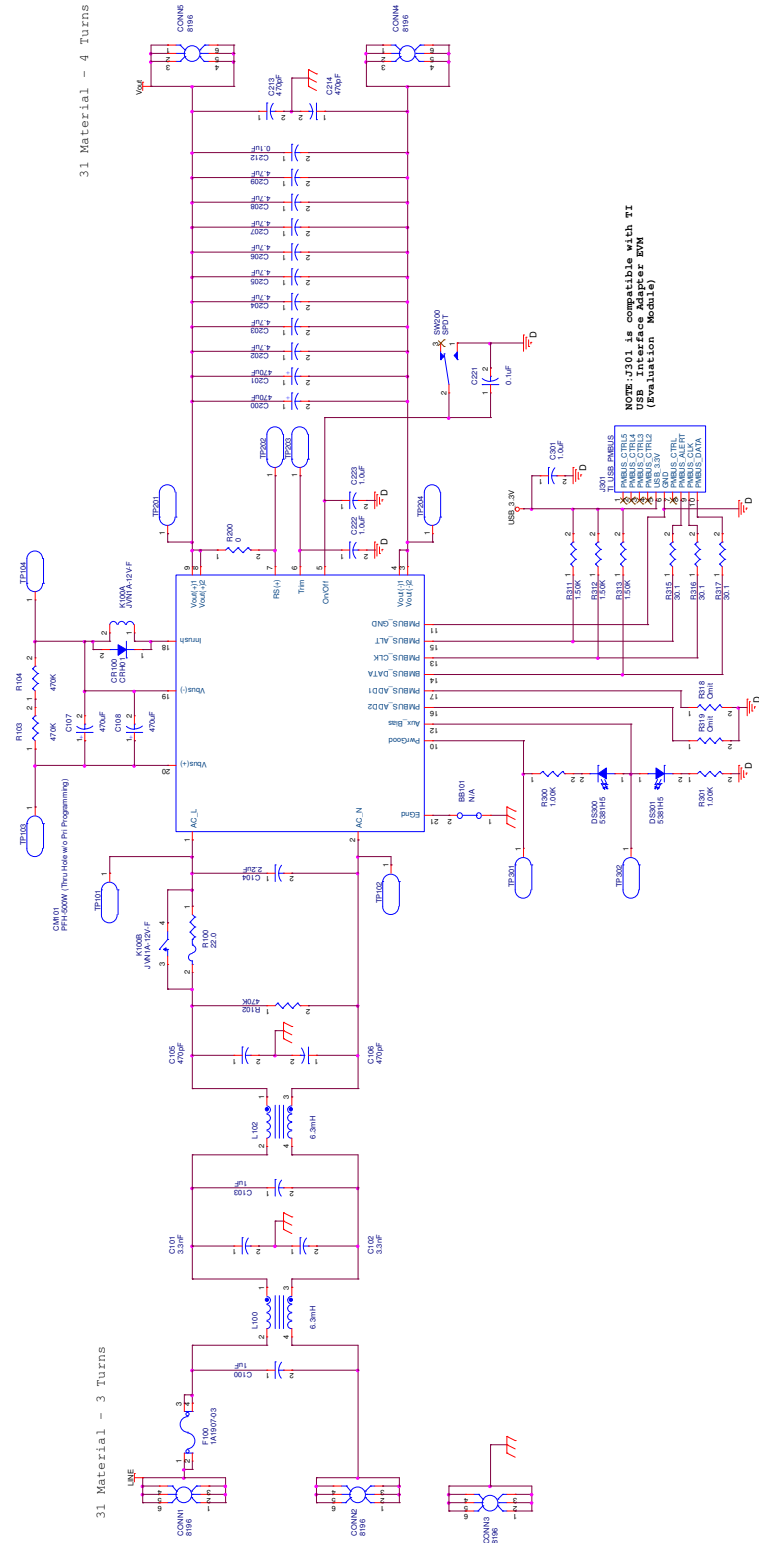

4.0 Bill of Material

Part Reference	Mfr Part Number1	Value	Description	Voltage	Mfr1
BMPR1 BMPR2 BMPR3 BMPR4 BMPR5 BMPR6	SJ-5027 (BLACK)	Rubber Bumper	Bumper, Rubber, 0.63" Dia x 0.31"		3M
C100 C103	B32923C3105M2040	1uF	Film Capacitor,305V, X2 Cap	250V	TDK
C101 C102	CS45-E2GA332M-NKA	3.3nF	Film Capacitor,305V, Y2 Cap	250V	TDK
C104	B32923C3225M1040	2.2uF	Film Capacitor,305V, X2 Cap	250V	TDK
C105 C106 C213 C214	CS45-B2GA471K-NKA	470pF	Film Capacitor,305V, Y2 Cap	250V	TDK
C107 C108	B43508B5477M007	470uF	Electrolytic Capacitor, 450V, 35X40	450V	TDK
C200 ₁ C201 ₁	EEUFC2A471	470uF	Electrolytic Capacitor, 100V, 16X40	100V	Panasonic
C200 ₂ C201 ₂	EEUFC1E152S	1500uF	Electrolytic Capacitor, 25V, 16X40	25V	Panasonic
C202 C203 C204 C205 C206 C207 C208 C209	C3225X7S2A475K200AB	4.7uF	Ceramic Capacitor, 100V, 1210, 4.7uF	100V	TDK
C212 C221	C2012X7R2A104K125AA	0.1uF	Ceramic Capacitor, 100V, 0805	100V	TDK
C222 C223	C3216X7R2A105MT	1.0uF	Ceramic Capacitor, 100V, 1206, 1.0uF	100V	TDK
C301	C2012X7R1E105KT	1.0uF	Ceramic Capacitor, 25V, 0805	25V	TDK
CM101 ₃	PFH500F-##-1*0-R		AC/DC Module, 504W		TDK
CONN1 CONN2 CONN3 CONN4 CONN5		8196	PC Screw Terminal		
CR100	CRH01	CRH01	PN Diode, Single Package, SMT		TOSHIBA
DS300 DS301	5381H5	5381H5	LED, Green, Thru Hole		Chicago Miniature Lamp
F100 F101	1A1907-03	1A1907-03	Fuse, Fuse holder, PWB		BUSSMANN
F102	312010	312010	Fuse, 10A Fuse, Fast-Blow		Littlefuse
J301	N2510-60XX	T1_USB_PMB US	.100" x .100" Four-Wall Header		3m
K100	JVN1A-12V-F	JVN1A-12V-F	RELAY SPST		Panasonic
L100 L102	ARA00499	6.3mH	Com Ind, 6325uH, Thru Hole		TDK-Lambda
PWB100	ZB00511	ZB00511	PWB, (n) oz. Cu, .062"		
R100	A5MC-220J	22.0	Res,22.0,1.6W	250V	UCHIHASHI
R102 R103 R104	SPR2C474J	470K	Res,470K,2.0W	250V	KOA SPEER
R200	RK73Z2ATTE	0	Res,0.2.0A,70C,0805	N/A	KOA SPEER
R300 R301	RK73H2ATTE1001F	1.00K	Res,1.00K,0.125W,100ppm,70C,0805	150V	KOA SPEER
R311 R312 R313	RK73H2ATTE1501F	1.50K	Res,1.50K,0.125W,100ppm,70C,0805	150V	KOA SPEER
R315 R316 R317	RK73H2ATTE30R1F	30.1	Res,30.1,0.125W,100ppm,70C,0805	150V	KOA SPEER
R318	N/A	Omit	Res,Omit,0805	N/A	N/A
R319	RK73H2ATTE1001F	1.00K	Res,1.00K, 0.125W,100ppm,70C,0805	150V	KOA SPEER
SW200	T101SHCQE	SPDT	SPDT two position switch vertical (On None On)		C&K
TP101 TP102 TP104 TP204	5011	5011	Test Point, Black, Thru Hole		Keystone Electronics
TP103 TP201 TP202	5010	5010	Test Point, Red, Thru Hole		Keystone Electronics
TP203 TP301 TP302	5014	5014	Test Point, Yellow, Thru Hole		Keystone Electronics

NOTE:

1. Output capacitors used on PFH05W28-100-EVK-S1 & PFH05W48-100-EVK-S1
2. Output capacitors used on PFH05W12-100-EVK-S1
3. ## - Denotes output voltage of (e.g. "28" for 28Vdc) and * denotes either Droop (1D0) or Non-Droop (100)

5.0 Board Files

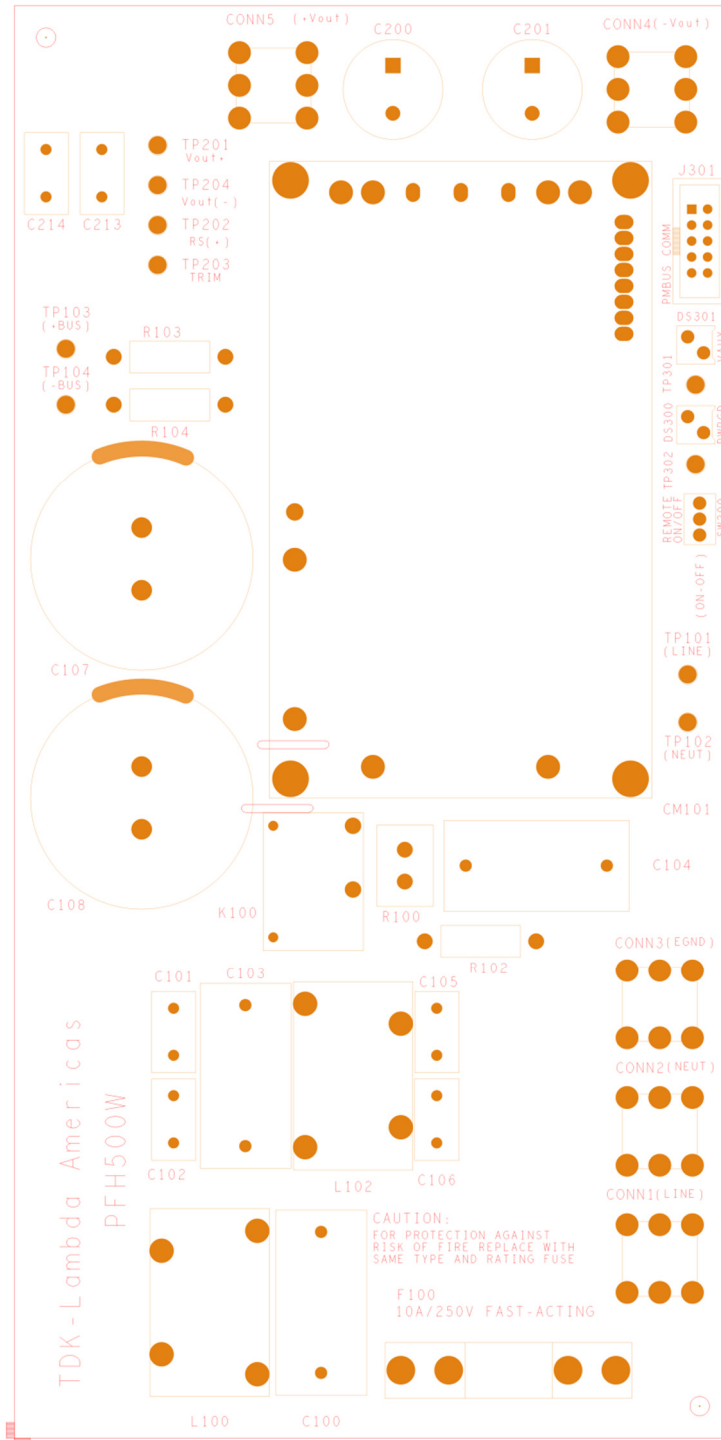

FIGURE 1 Top side Component Placement

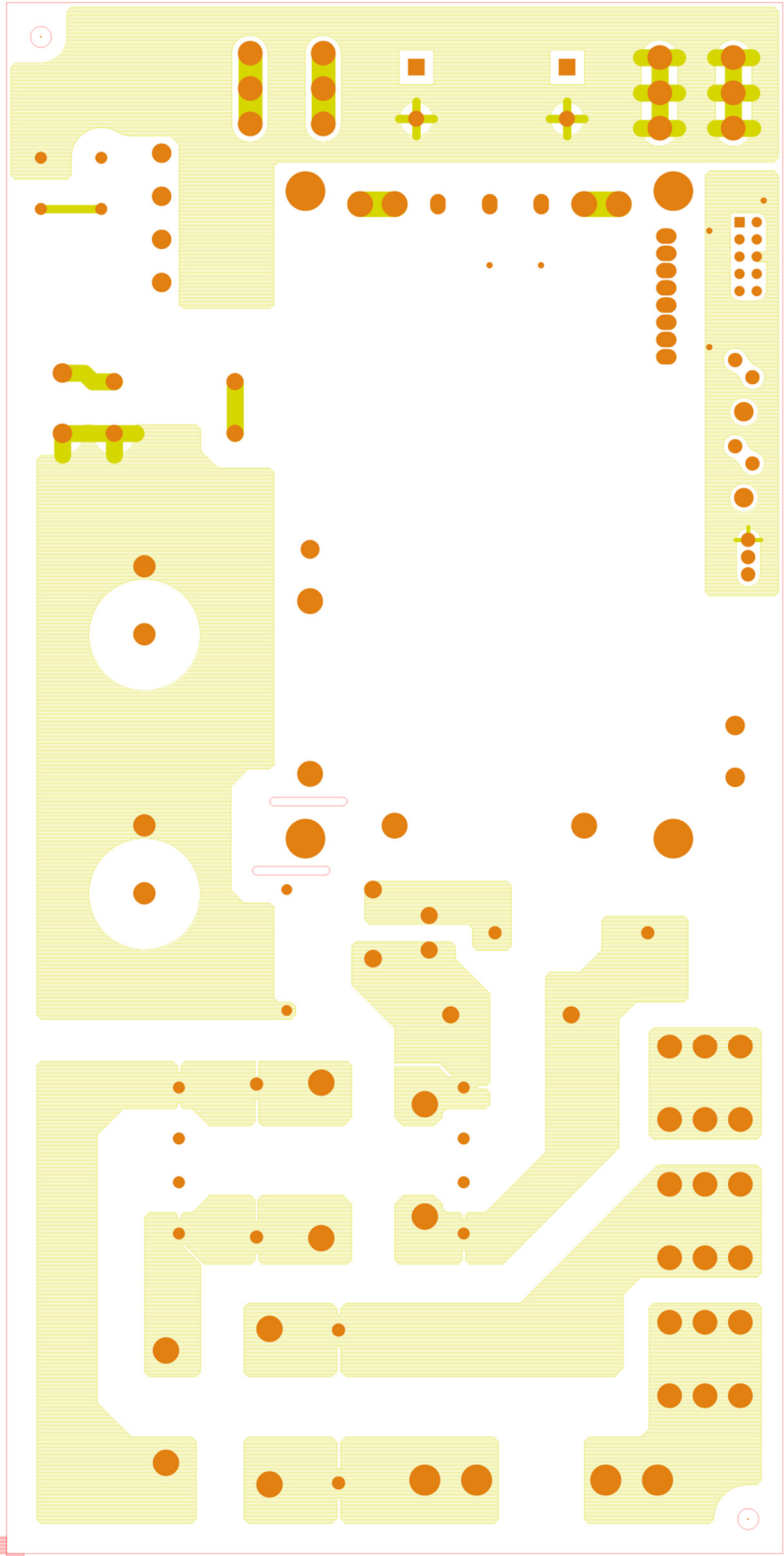

FIGURE 2 Top Layer (Etch 1)

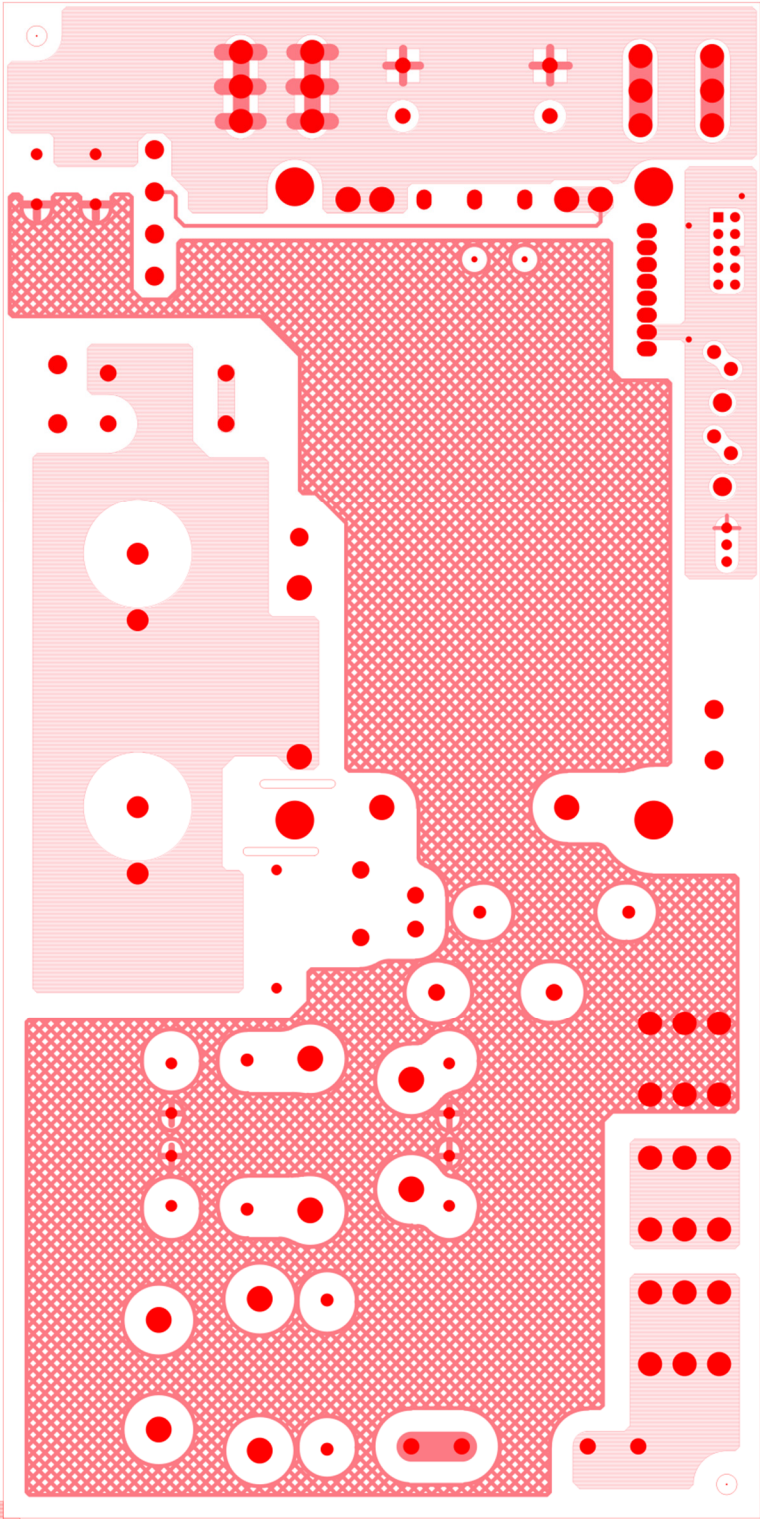

FIGURE 3 Internal Layer (Etch 2)

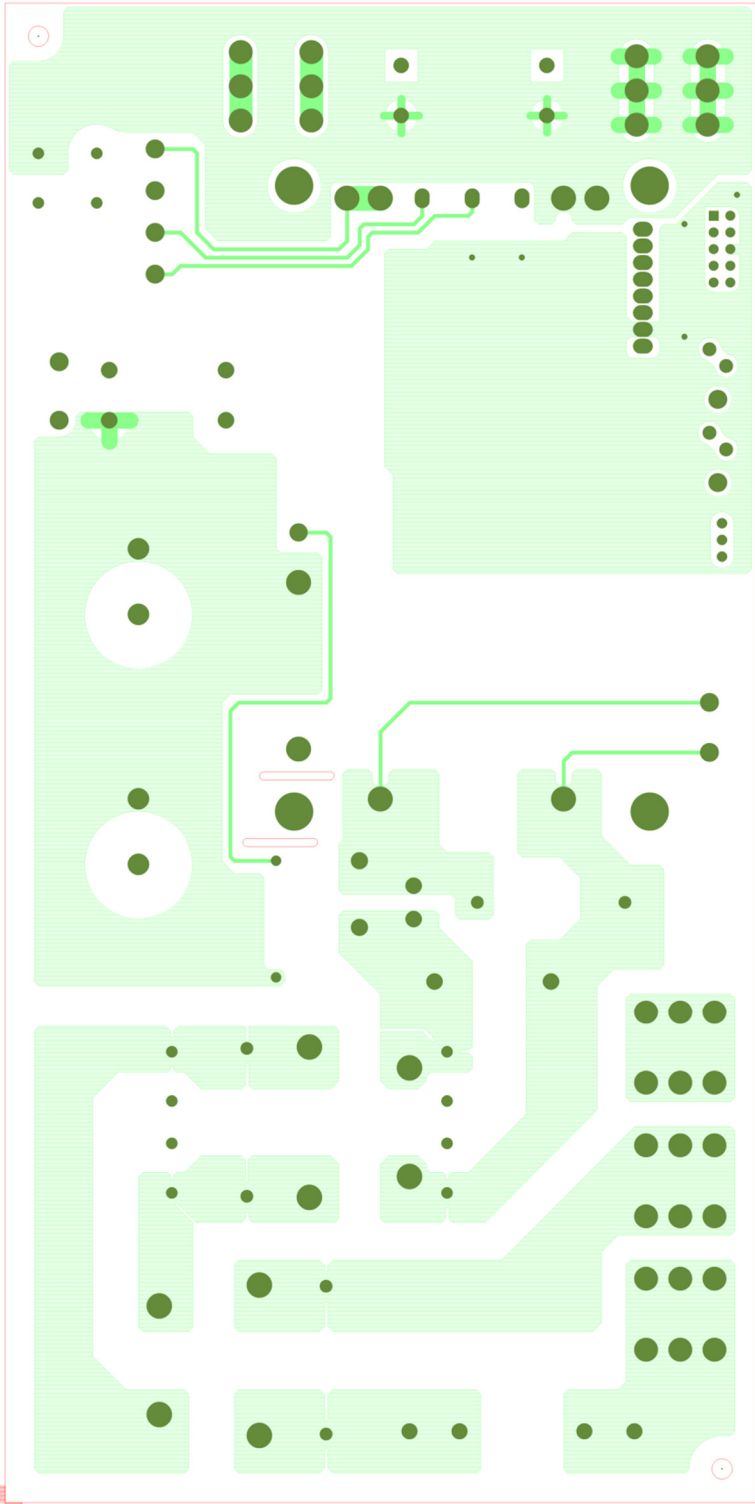

FIGURE 4 Internal Layer (Etch 3)

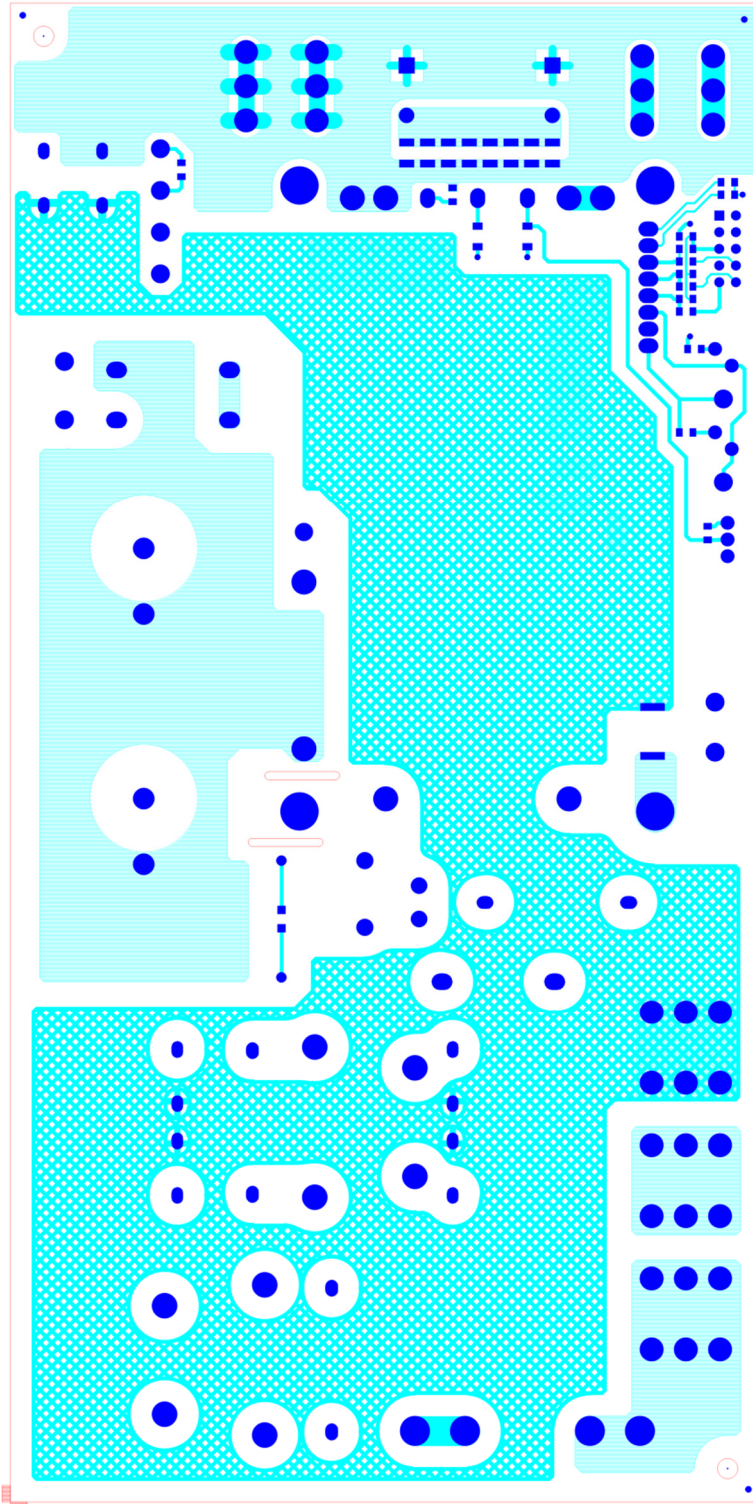

FIGURE 5 Bottom Layer (Etch 4)

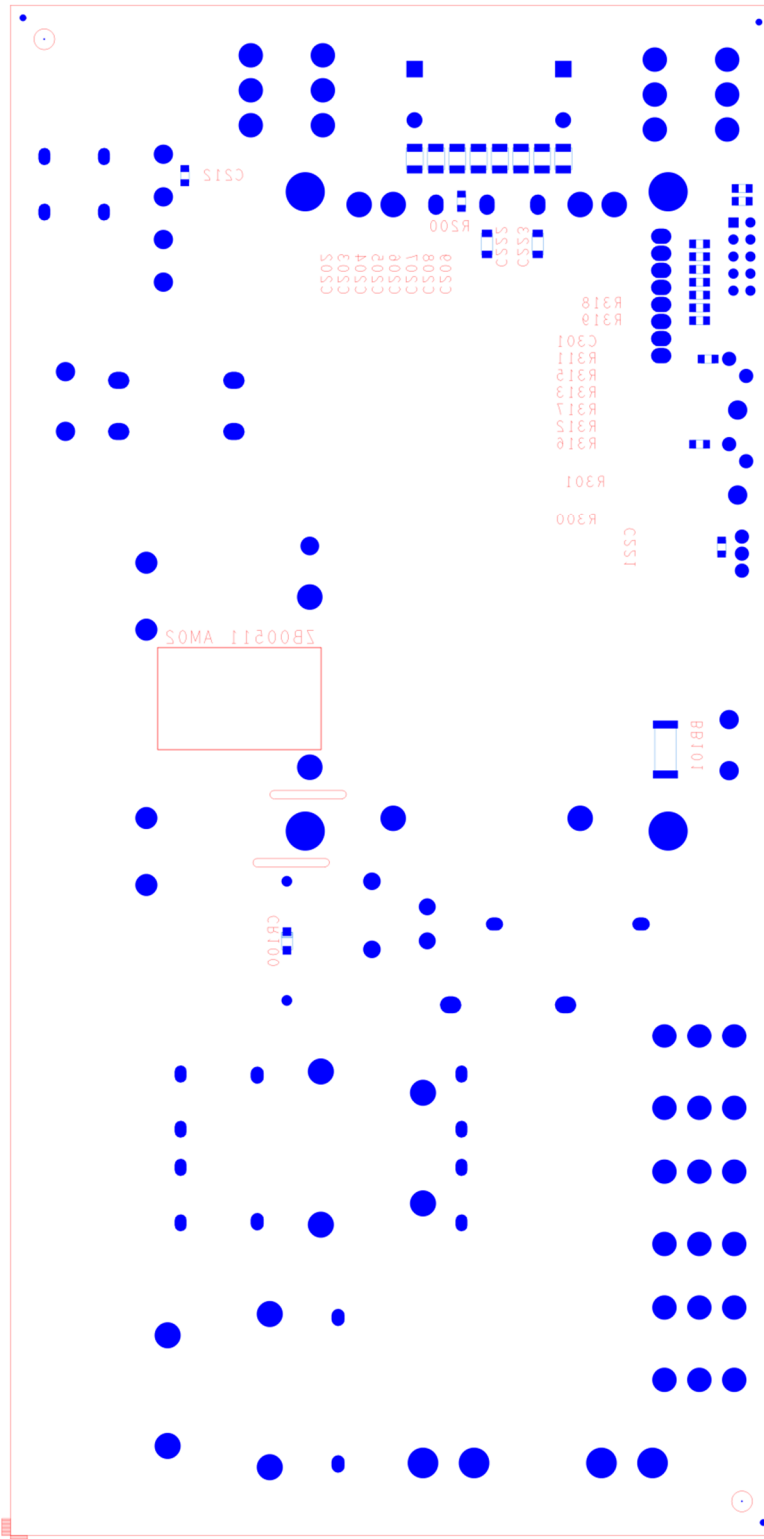

FIGURE 6 Bottom side Component Placement

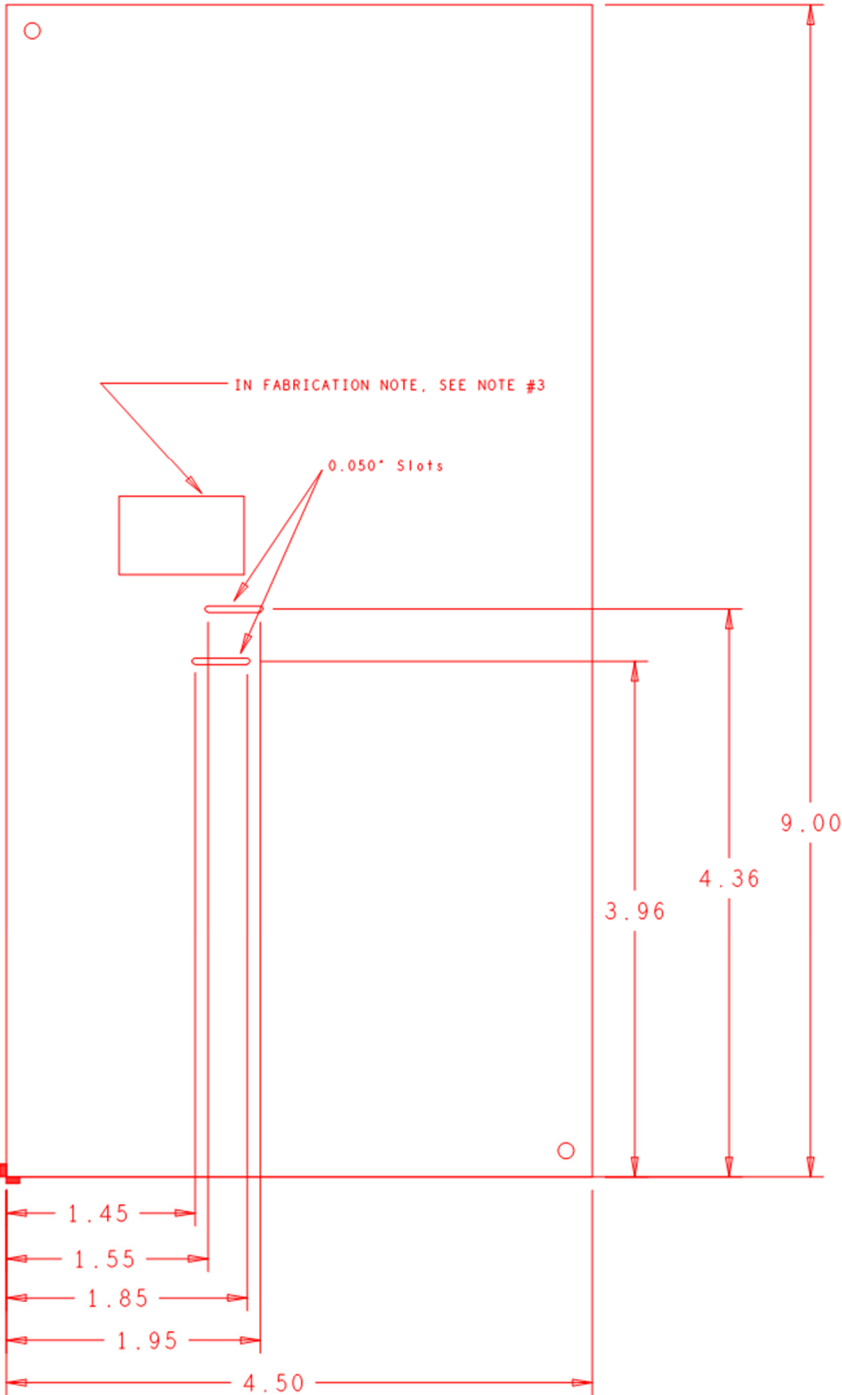

FIGURE 7 Circuit Outline



TDK-Lambda France SAS

Tel: +33 1 60 12 71 65
france@fr.tdk-lambda.com
www.emea.lambda.tdk.com/fr



Italy Sales Office

Tel: +39 02 61 29 38 63
info.italia@it.tdk-lambda.com
www.emea.lambda.tdk.com/it



Netherlands

info@nl.tdk-lambda.com
www.emea.lambda.tdk.com/nl



TDK-Lambda Germany GmbH

Tel: +49 7841 666 0
info.germany@de.tdk-lambda.com
www.emea.lambda.tdk.com/de



Austria Sales Office

Tel: +43 2256 655 84
info@at.tdk-lambda.com
www.emea.lambda.tdk.com/at



Switzerland Sales Office

Tel: +41 44 850 53 53
info@ch.tdk-lambda.com
www.emea.lambda.tdk.com/ch



Nordic Sales Office

Tel: +45 8853 8086
info@dk.tdk-lambda.com
www.emea.lambda.tdk.com/dk

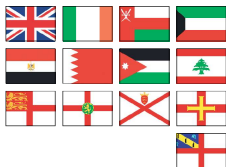

TDK-Lambda UK Ltd.

Tel: +44 (0) 12 71 85 66 66
powersolutions@uk.tdk-lambda.com
www.emea.lambda.tdk.com/uk



TDK-Lambda Ltd.

Tel: +9 723 902 4333
info@tdk-lambda.co.il
www.emea.lambda.tdk.com/il



C.I.S.

Commercial Support:

Tel: +7 (495) 665 2627

Technical Support:

Tel: +7 (812) 658 0463
info@tdk-lambda.ru
www.emea.lambda.tdk.com/ru



TDK-Lambda Americas

Tel: +1 800-LAMBDA-4 or 1-800-526-2324
powersolutions@us.tdk-lambda.com
www.us.lambda.tdk.com



TDK Electronics do Brasil Ltda

Tel: +55 11 3289-9599
sales.br@tdk-electronics.tdk.com
www.tdk-electronics.tdk.com/en



TDK-Lambda Corporation

Tel: +81-3-6778-1113
www.jp.lambda.tdk.com



TDK-Lambda (China) Electronics Co. Ltd.

Tel: +86 21 6485-0777
powersolutions@cn.tdk-lambda.com
www.lambda.tdk.com.cn



TDK-Lambda Singapore Pte Ltd.

Tel: +65 6251 7211
tfs.mkt@sg.tdk-lambda.com
www.sg.lambda.tdk.com



TDK India Private Limited, Power Supply Division

Tel: +91 80 4039-0660
mathew.philip@in.tdk-lambda.com
www.sg.lambda.tdk.com

