

## LM4922 Boomer™ Audio Power Amplifier Series Ground-Referenced, Ultra Low Noise, Fixed Gain, 80mW Stereo Headphone Amplifier

Check for Samples: [LM4922](#)

### FEATURES

- Fixed Logic Levels
- Ground Referenced Outputs
- High PSRR
- Available in Space-Saving DSBGA Package
- Ultra Low Current Shutdown Mode
- Improved Pop and Click Circuitry Eliminates Noises During Turn-On and Turn-Off Transitions
- No Output Coupling Capacitors, Snubber Networks, Bootstrap Capacitors, or Gain-Setting Resistors Required
- Shutdown either channel independently

### APPLICATIONS

- Notebook PCs
- Mobile Phone
- PDAs
- Portable Electronic Devices
- MP3 Players

### KEY SPECIFICATIONS

- Improved PSRR at 217Hz, 70dB (Typ)
- Power Output at  $V_{DD} = 3V$ ,  $R_L = 16\Omega$ , THD  $\leq 1\%$ , 80mW (Typ)
- Shutdown Current, 0.01 $\mu$ A (Typ)
- Internal Fixed Gain, 1.5V/V (Typ)
- Operating Voltage, 1.6V to 4.2V

### DESCRIPTION

The LM4922 is a ground referenced, fixed-gain audio power amplifier capable of delivering 80mW of continuous average power into a 16 $\Omega$  single-ended load with less than 1% THD+N from a 3V power supply.

The LM4922 features a new circuit technology that utilizes a charge pump to generate a negative reference voltage. This allows the outputs to be biased about ground, thereby eliminating output-coupling capacitors typically used with normal single-ended loads.

The LM4922 features an Automatic Standby Mode circuitry (patent pending). In the absence of an input signal, after approximately 12 seconds, the LM4922 goes into low current standby mode. The LM4922 recovers into full power operating mode immediately after a signal is applied to either the left or right input pins. This feature saves power supply current in battery operated applications.

Boomer audio power amplifiers were designed specifically to provide high quality output power with a minimal amount of external components. The LM4922 does not require output coupling capacitors or bootstrap capacitors, and therefore is ideally suited for mobile phone and other low voltage applications where minimal power consumption is a primary requirement.

The LM4922 features a low-power consumption shutdown mode selectable for either channel separately. This is accomplished by driving either the SD\_RC (Shutdown Right Channel) or SD\_LC (Shutdown Left Channel) (or both) pins with logic low, depending on which channel is desired shutdown. Additionally, the LM4922 features an internal thermal shutdown protection mechanism.

The LM4922 contains advanced pop and click circuitry that eliminates noises which would otherwise occur during turn-on and turn-off transitions.

The LM4922 has an internal fixed gain of 1.5V/V.



Please be aware that an important notice concerning availability, standard warranty, and use in critical applications of Texas Instruments semiconductor products and disclaimers thereto appears at the end of this data sheet.

Boomer is a trademark of Texas Instruments.

All other trademarks are the property of their respective owners.



These devices have limited built-in ESD protection. The leads should be shorted together or the device placed in conductive foam during storage or handling to prevent electrostatic damage to the MOS gates.

**Typical Application**

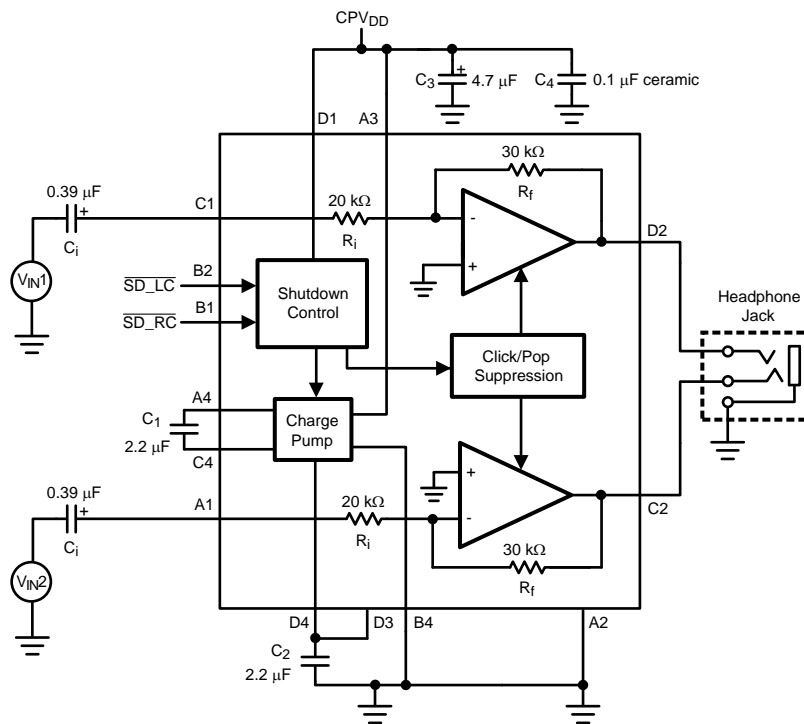

**Figure 1. Typical Audio Amplifier Application Circuit**

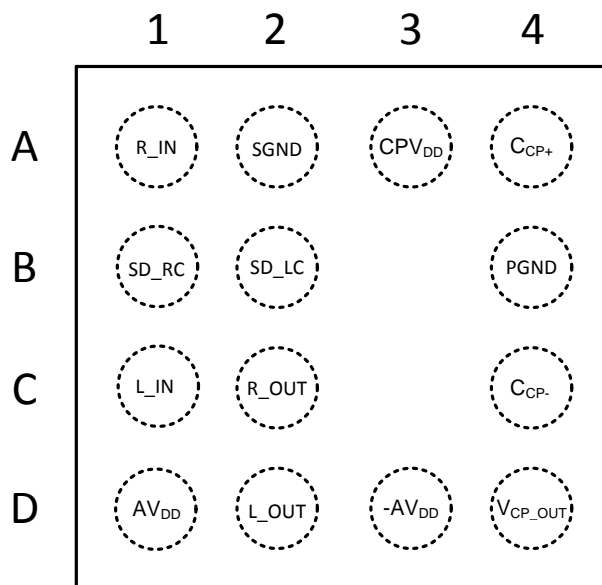

**Figure 2. DSBGA Package Top View**  
See Package Number YZE0014

### PIN DESCRIPTIONS

Pin	Name	Function
A1	R_IN	Right Channel Input
A2	SGND	Signal Ground
A3	CPV <sub>DD</sub>	Charge Pump Power Supply
A4	C <sub>CP+</sub>	Positive Terminal - Charge Pump Flying Capacitor
B1	SD_RC	Active-Low Shutdown, Right Channel
B2	SD_LC	Active-Low Shutdown, Left Channel
B4	PGND	Power Ground
C1	L_IN	Left Channel Input
C2	R_OUT	Right Channel Input
C4	C <sub>CP-</sub>	Negative Terminal - Charge Pump Flying Capacitor
D1	+AV <sub>DD</sub>	Positive Power Supply - Amplifier
D2	L_OUT	Left Channel Output
D3	-AV <sub>DD</sub>	Negative Power Supply - Amplifier
D4	V <sub>CP_OUT</sub>	Charge Pump Power Output

### Absolute Maximum Ratings<sup>(1)(2)</sup>

Supply Voltage	4.5V
Storage Temperature	-65°C to +150°C
Input Voltage	-0.3V to V <sub>DD</sub> + 0.3V
Power Dissipation <sup>(3)</sup>	Internally Limited
ESD Susceptibility <sup>(4)(5)</sup>	2000V
ESD Susceptibility <sup>(6)(5)</sup>	200V
Junction Temperature	150°C
Thermal Resistance	$\theta_{JA}$ (typ) YZE0014 <sup>(7)</sup> 86°C/W

- (1) Absolute Maximum Ratings indicate limits beyond which damage to the device may occur. Operating Ratings indicate conditions for which the device is functional but do not specify performance limits. Electrical Characteristics state DC and AC electrical specifications under particular test conditions that ensure specific performance limits. This assumes that the device is within the Operating Ratings. Specifications are for parameters where no limit is given; however, the typical value is a good indication of device performance.
- (2) If Military/Aerospace specified devices are required, please contact the Texas Instruments Sales Office/Distributors for availability and specifications.
- (3) The maximum power dissipation must be derated at elevated temperatures and is dictated by T<sub>JMAX</sub>,  $\theta_{JA}$ , and the ambient temperature, T<sub>A</sub>. The maximum allowable power dissipation is P<sub>DMAX</sub> = (T<sub>JMAX</sub> - T<sub>A</sub>) /  $\theta_{JA}$  or the number given in Absolute Maximum Ratings, whichever is lower. For the LM4922, see power de-rating currents for more information.
- (4) Human body model, 100pF discharged through a 1.5k $\Omega$  resistor.
- (5) If the product is in shutdown mode and V<sub>DD</sub> exceeds 4.2V (to a max of 4.5V V<sub>DD</sub>), then most of the excess current will flow through the ESD protection circuits. If the source impedance limits the current to a max of 10mA, then the part will be protected. If the part is enabled when V<sub>DD</sub> is above 4.5V, circuit performance will be curtailed or the part may be permanently damaged.
- (6) Machine Model, 220pF - 240pF discharged through all pins.
- (7)  $\theta_{JA}$  value is measured with the device mounted on a PCB with a 3" x 1.5", 1oz copper heatsink.

### Operating Ratings

Temperature Range	T <sub>MIN</sub> ≤ T <sub>A</sub> ≤ T <sub>MAX</sub>	-40°C ≤ T <sub>A</sub> ≤ 85°C
Supply Voltage (V <sub>DD</sub> )		1.6V ≤ V <sub>DD</sub> ≤ 4.2V

## Electrical Characteristics $V_{DD} = 3V^{(1)}$

The following specifications apply for  $V_{DD} = 3V$  and  $16\Omega$  load unless otherwise specified. Limits apply to  $T_A = 25^\circ C$ .

Symbol	Parameter	Conditions	LM4922		Units (Limits)
			Typ <sup>(2)</sup>	Limit <sup>(3)(4)</sup>	
$I_{DD}$	Quiescent Power Supply Current Auto Standby Mode	$V_{IN} = 0V$ , inputs terminated both channels enabled	2.3		mA
	Quiescent Power Supply Current Full Power Mode	$V_{IN} = 0V$ , inputs terminated both channels enabled	7	10	mA (max)
		$V_{IN} = 0V$ , inputs terminated one channel enabled	5		mA
$I_{SD}$	Shutdown Current	$V_{SD\_LC} = V_{SD\_RC} = GND$	0.1	1.8	$\mu A$ (max)
$V_{OS}$	Output Offset Voltage	$R_L = 32\Omega$ , $V_{IN} = 0V$	0.7	5	mV (max)
$A_V$	Voltage Gain		-1.5		V/V
$\Delta A_V$	Gain Match		1		%
$R_{IN}$	Input Resistance		20	15 25	k $\Omega$ (min) k $\Omega$ (max)
$P_O$	Output Power	THD+N = 1% (max); f = 1kHz, $R_L = 16\Omega$ , one channel	80		mW
		THD+N = 1% (max); f = 1kHz, $R_L = 32\Omega$ , one channel	65		mW
		THD+N = 1% (max); f = 1kHz, $R_L = 16\Omega$ , (two channels in phase)	43	38	mW (min)
		THD+N = 1% (max); f = 1kHz, $R_L = 32\Omega$ , (two channels in phase)	50	45	mW (min)
THD+N	Total Harmonic Distortion + Noise	$P_O = 60mW$ , f = 1kHz, $R_L = 16\Omega$ single channel	0.04		%
		$P_O = 50mW$ , f = 1kHz, $R_L = 32\Omega$ single channel	0.03		
PSRR	Power Supply Rejection Ratio Full Power Mode	$V_{RIPPLE} = 200mVp-p$ , Input Referred			dB
		f = 217Hz	70		
		f = 1kHz	65		
		f = 20kHz	50		
SNR	Signal-to-Noise Ratio	$R_L = 32\Omega$ , $P_{OUT} = 20mW$ , (A-weighted) f = 1kHz, BW = 20Hz to 22kHz	100		dB
$V_{IH}$	Shutdown Input Voltage High	$V_{DD} = 1.8V$ to $4.2V$		1.2	V (min)
$V_{IL}$	Shutdown Input Voltage Low	$V_{DD} = 1.8V$ to $4.2V$		0.45	V (max)
$T_{WU}$	Wake Up Time From Auto- Standby		5		$\mu s$
$X_{TALK}$	Crosstalk	$R_L = 16\Omega$ , $P_O = 1.6mW$ , f = 1kHz	60		dB
$Z_{OUT}$	Output Impedance	$V_{SD-LC} = V_{SD-RC} = GND$ Input Terminated Input not terminated	50 $\infty$	30	k $\Omega$
$Z_{OUT}$	Output Impedance	$V_{SD-LC} = V_{SD-RC} = GND$ $-500mV \leq V_{OUT} \leq +500mV^{(5)}$	8	2	k $\Omega$ (min)
$I_L$	Input Leakage		$\pm 0.1$		nA
$V_{IN\_THRESH}$	Input Voltage Threshold		2.8		mVp

- (1) All voltages are measured with respect to the GND pin unless otherwise specified.
- (2) Typicals are measured at  $25^\circ C$  and represent the parametric norm.
- (3) Limits are specified to AOQL (Average Outgoing Quality Level).
- (4) Datasheet min/max specification limits are specified by design, test, or statistical analysis.
- (5)  $V_{OUT}$  refers to signal applied to the LM4922 outputs.

## External Components Description

(See [Figure 1](#))

Components		Functional Description
1.	$C_i$	Input coupling capacitor which blocks the DC voltage at the amplifier's input terminals. Also creates a high-pass filter with $R_i$ at $f_C = 1/(2\pi R_i C_i)$ . Refer to the section <b>Proper Selection of External Components</b> , for an explanation of how to determine the value of $C_i$ .
2.	$C_1$	Flying capacitor. Low ESR ceramic capacitor ( $\leq 100\text{m}\Omega$ )
3.	$C_2$	Output capacitor. Low ESR ceramic capacitor ( $\leq 100\text{m}\Omega$ )
4.	$C_3$	Tantalum capacitor. Supply bypass capacitor which provides power supply filtering. Refer to the Power Supply Bypassing section for information concerning proper placement and selection of the supply bypass capacitor.
5.	$C_4$	Ceramic capacitor. Supply bypass capacitor which provides power supply filtering. Refer to the Power Supply Bypassing section for information concerning proper placement and selection of the supply bypass capacitor.

## Typical Performance Characteristics

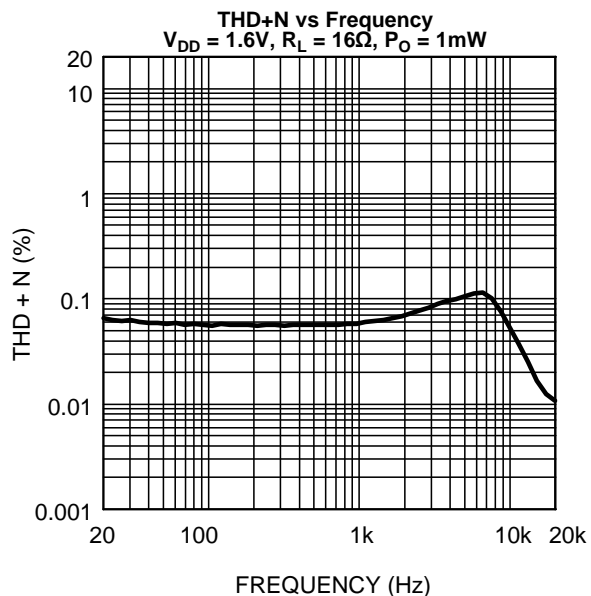

Figure 3.

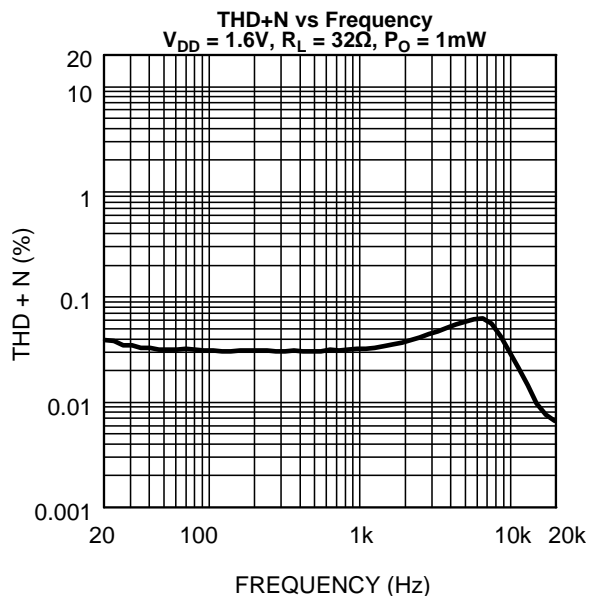

Figure 4.

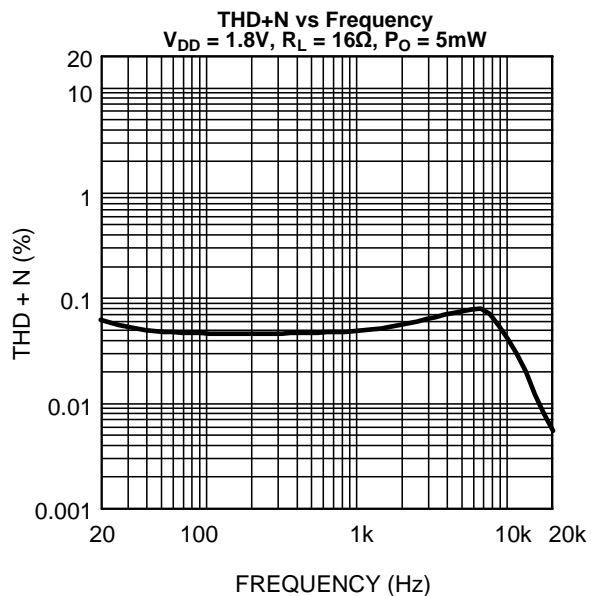

Figure 5.

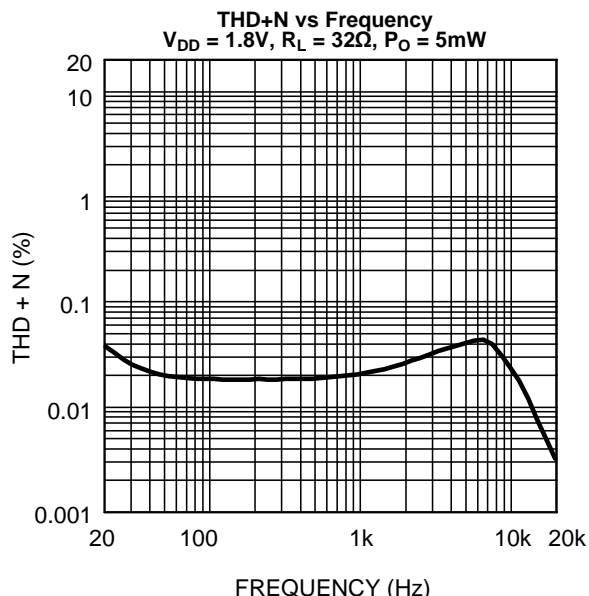

Figure 6.

**Typical Performance Characteristics (continued)**

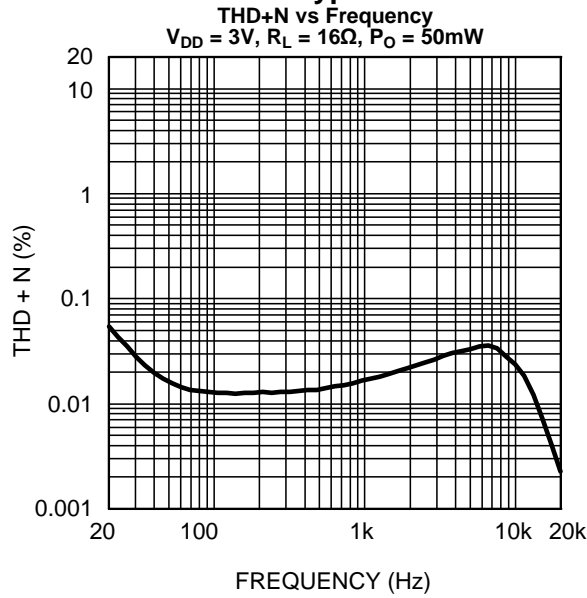

Figure 7.

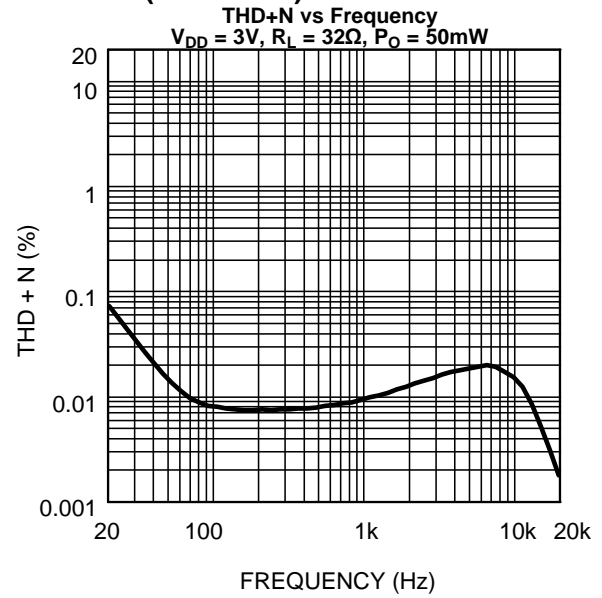

Figure 8.

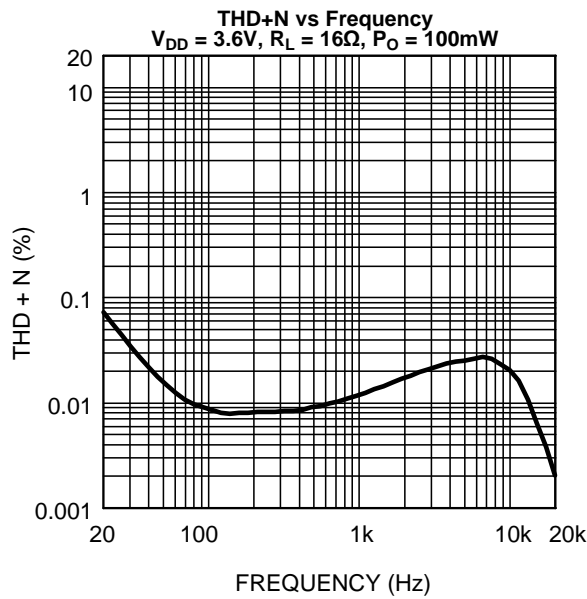

Figure 9.

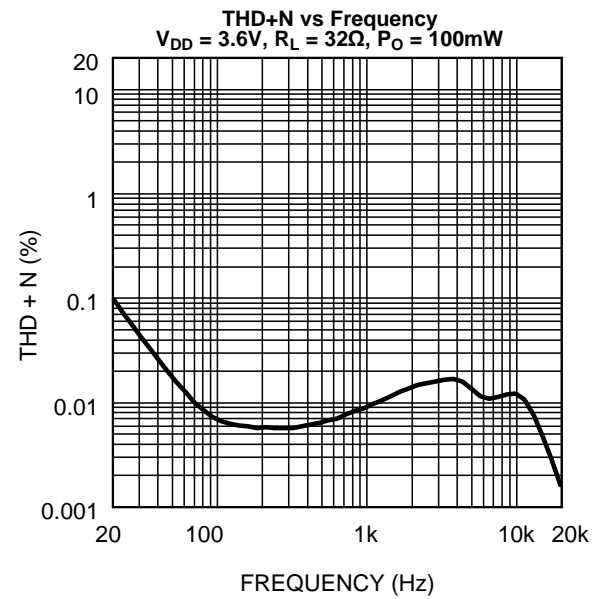

Figure 10.

### Typical Performance Characteristics (continued)

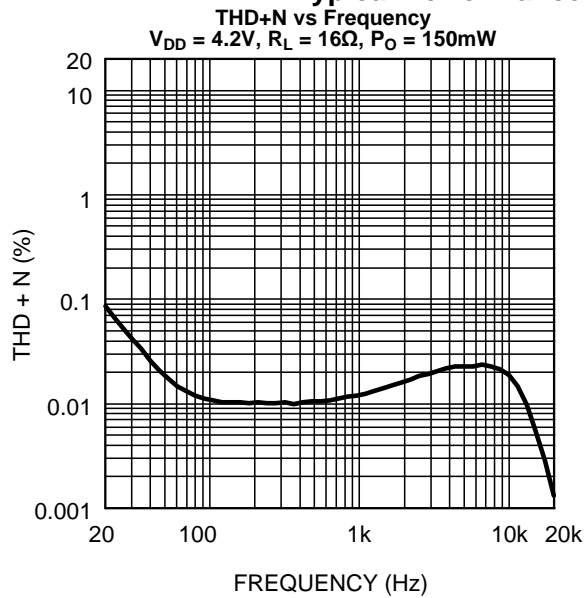

Figure 11.

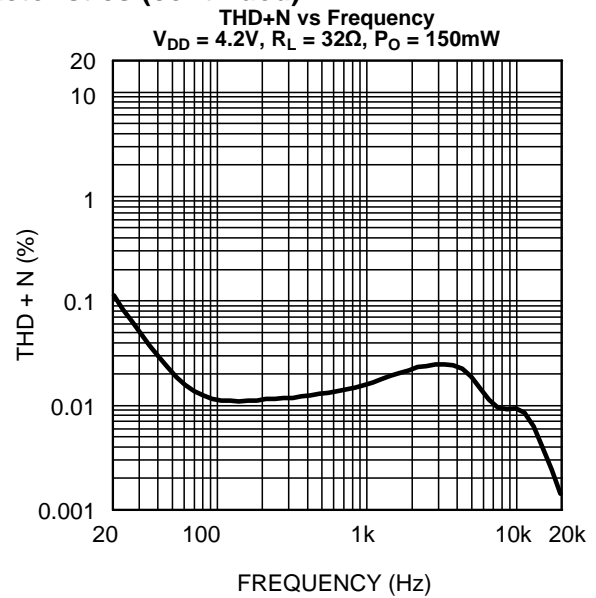

Figure 12.

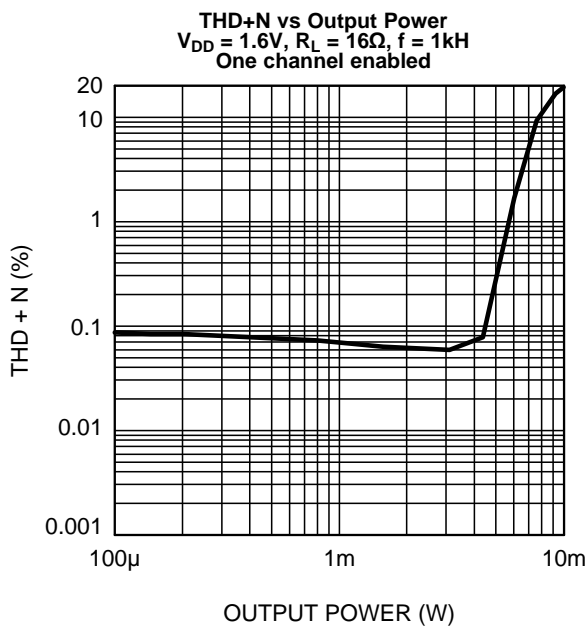

Figure 13.

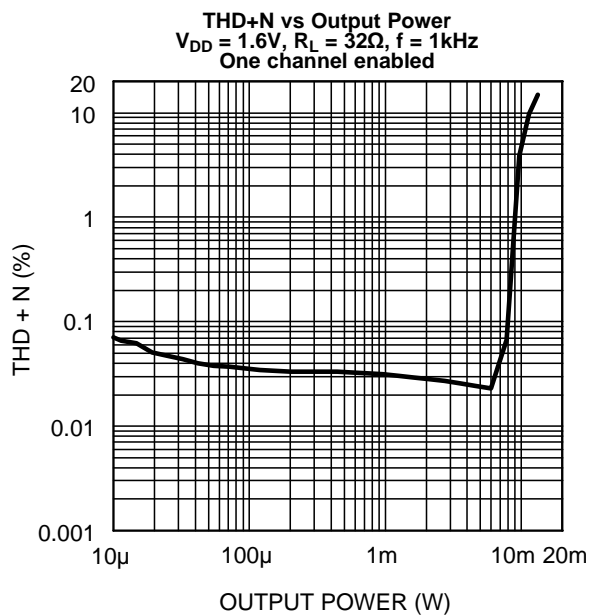

Figure 14.



Typical Performance Characteristics (continued)

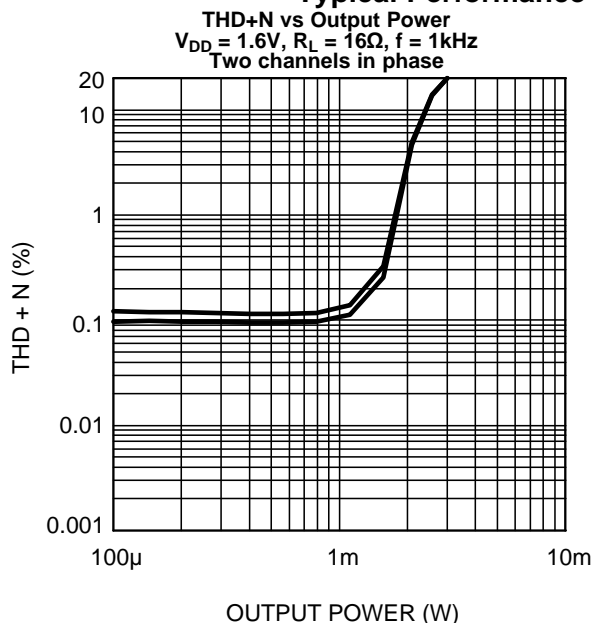

Figure 15.

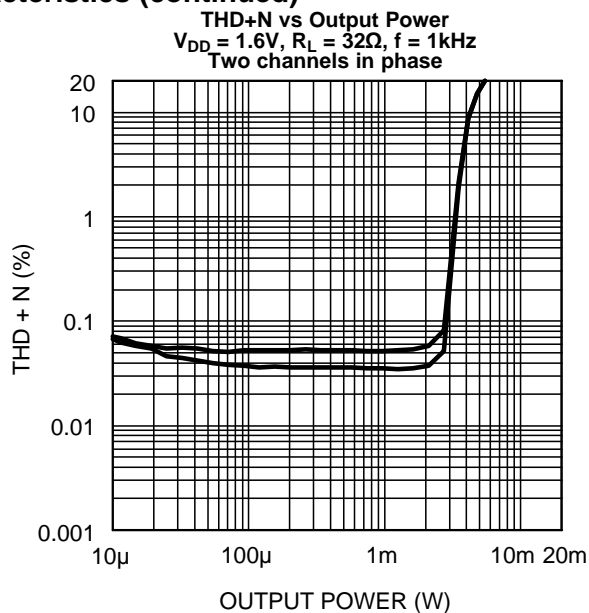

Figure 16.

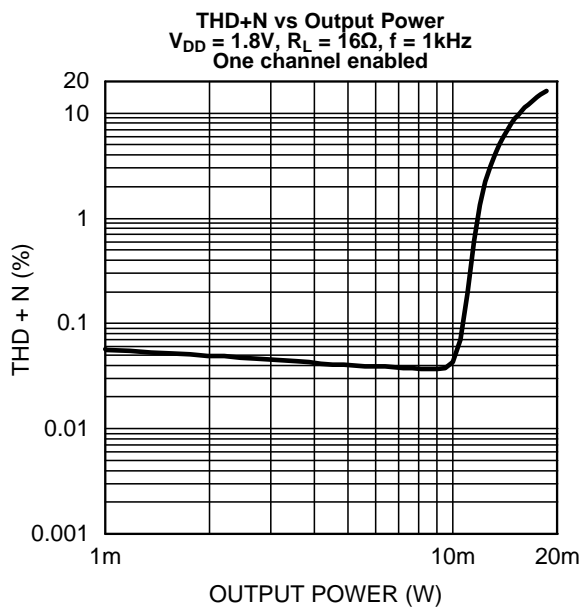

Figure 17.

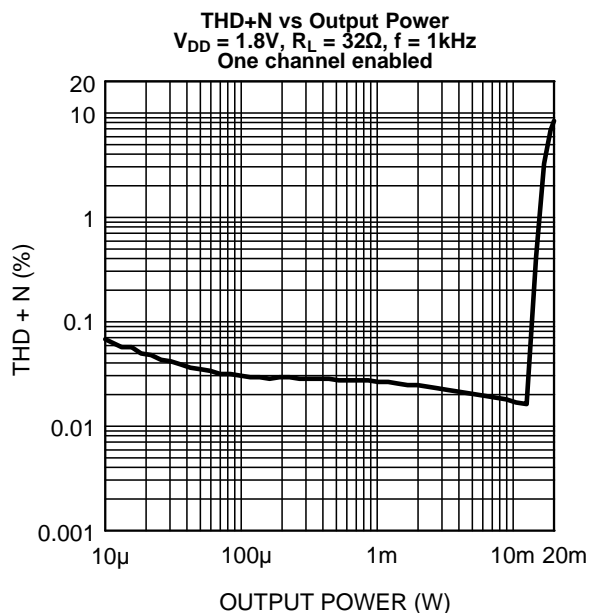

Figure 18.

### Typical Performance Characteristics (continued)

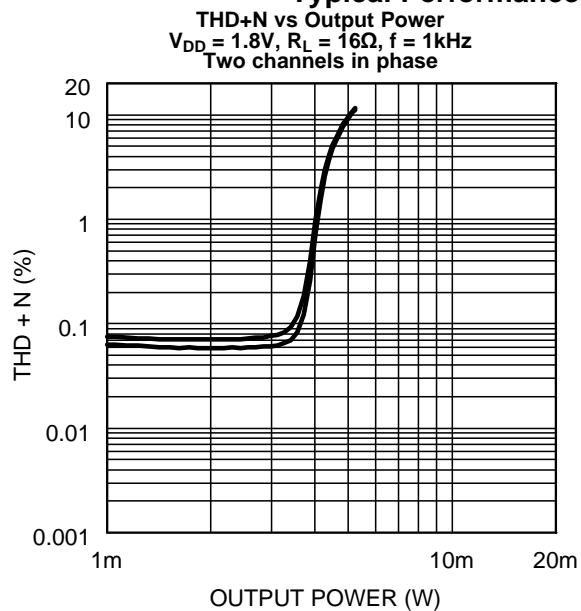

Figure 19.

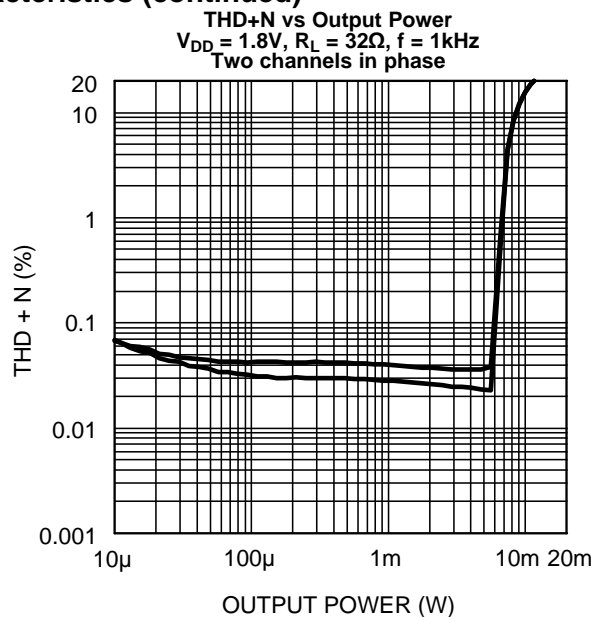

Figure 20.

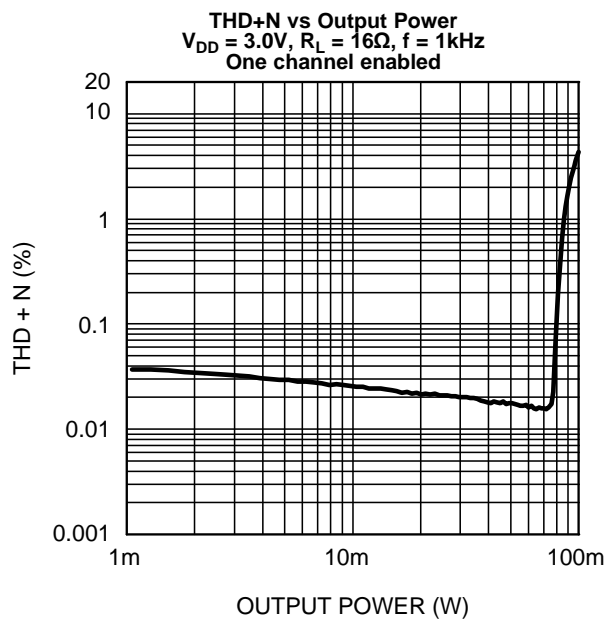

Figure 21.

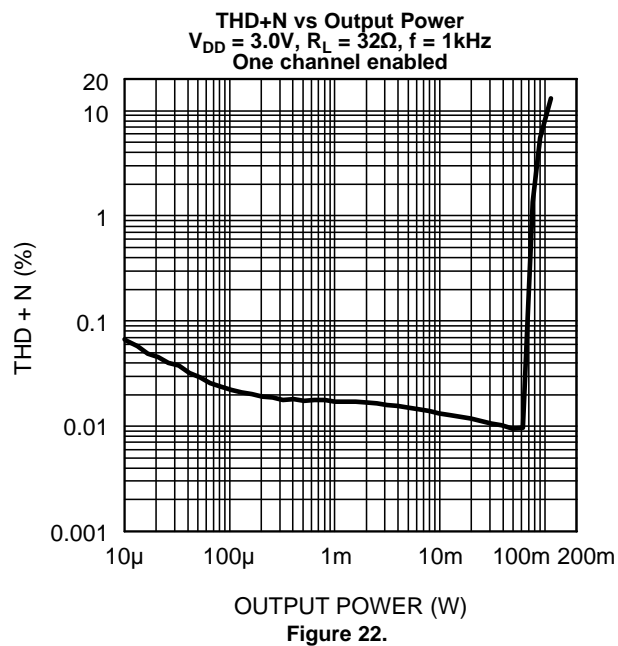

Figure 22.

**Typical Performance Characteristics (continued)**

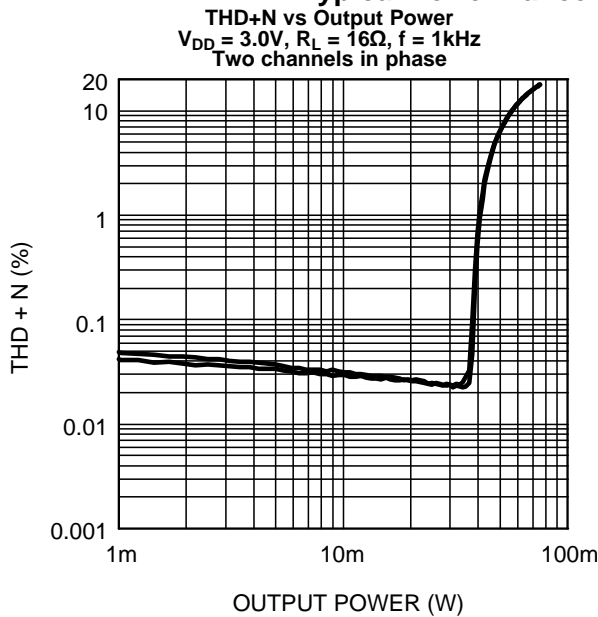

Figure 23.

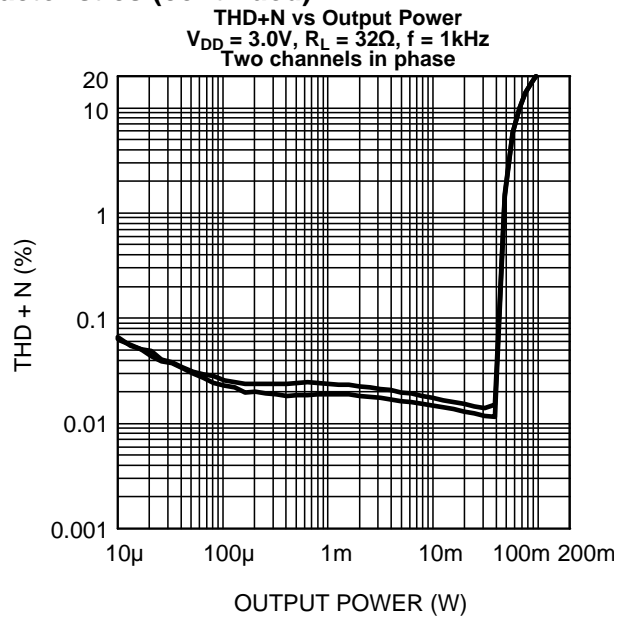

Figure 24.

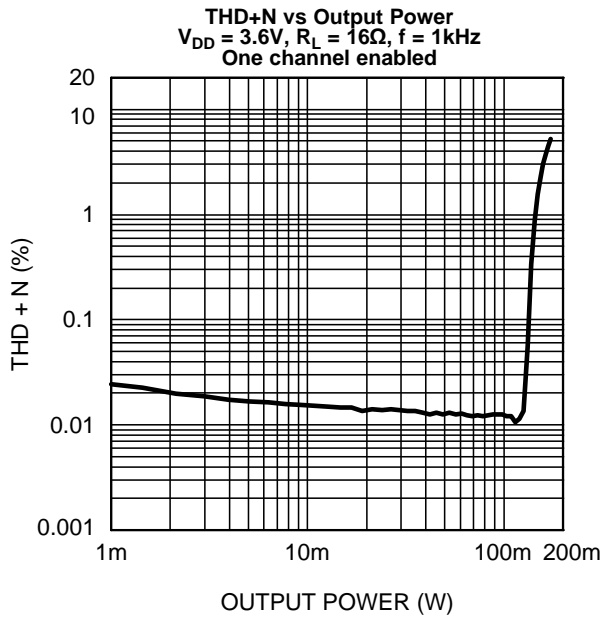

Figure 25.

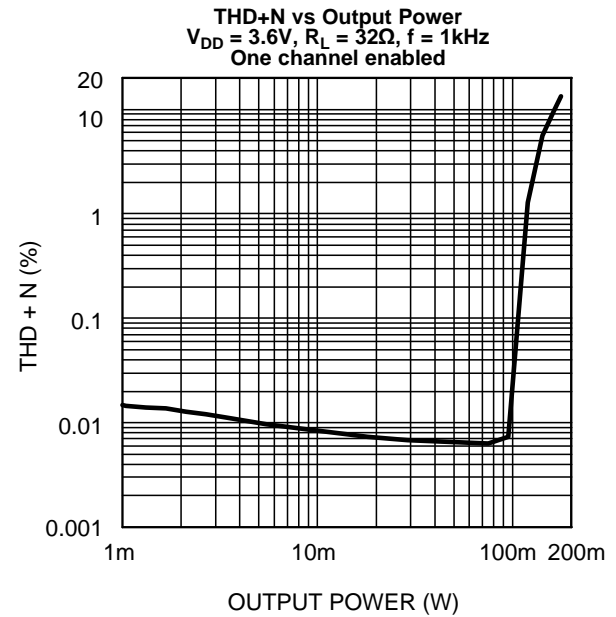

Figure 26.

### Typical Performance Characteristics (continued)

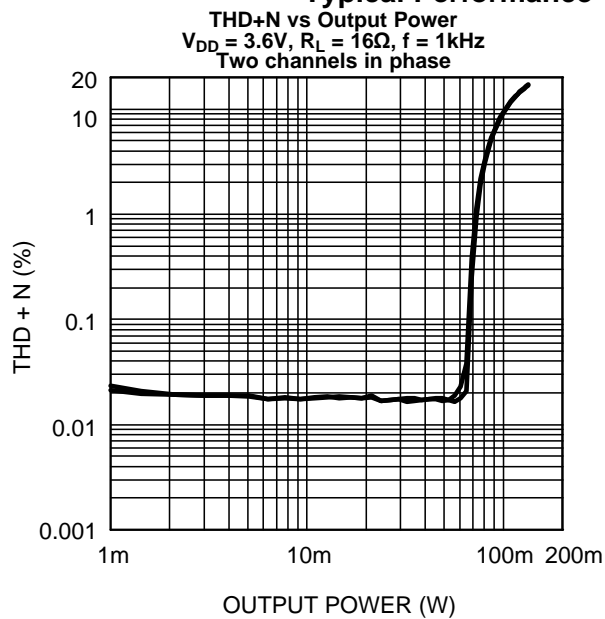

Figure 27.

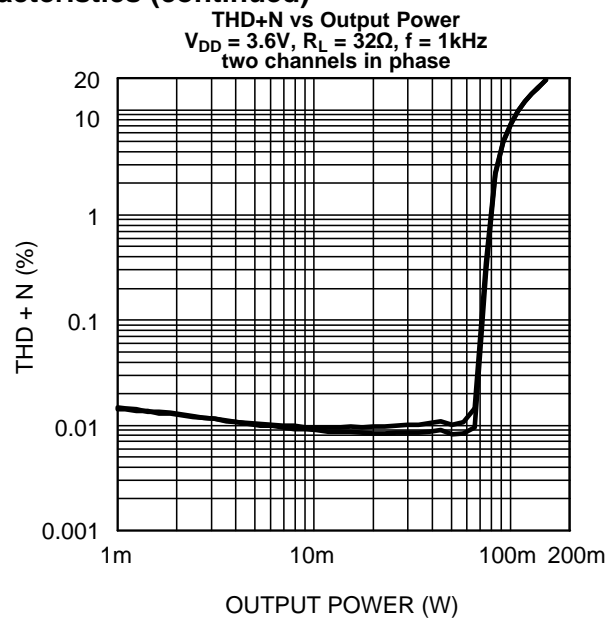

Figure 28.

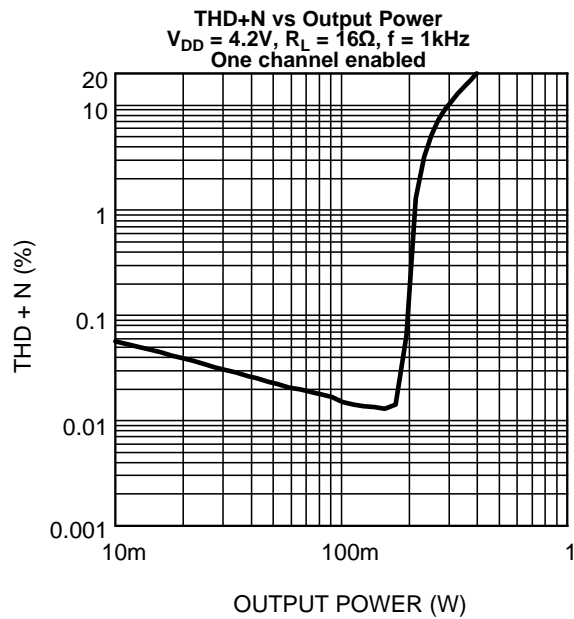

Figure 29.

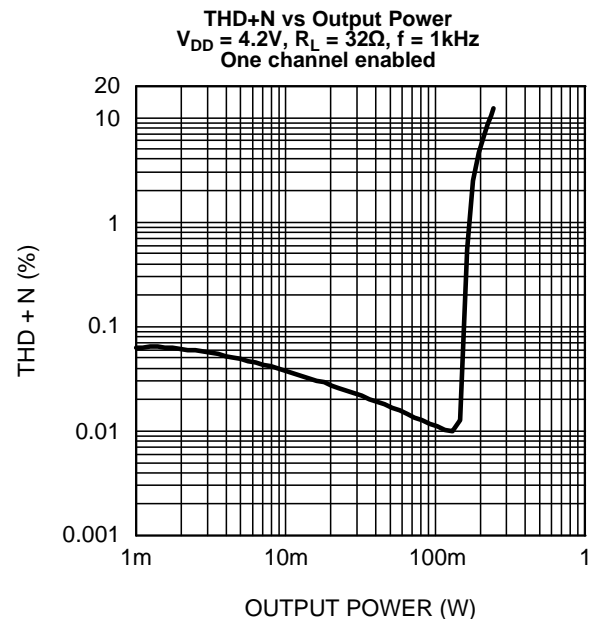

Figure 30.

Typical Performance Characteristics (continued)

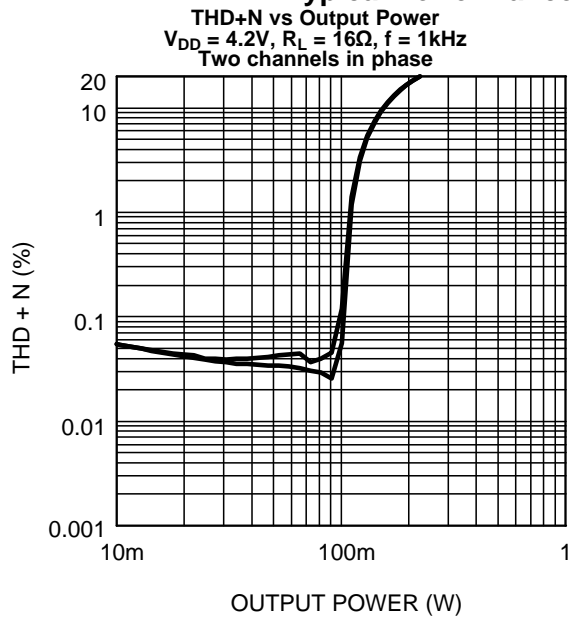

Figure 31.

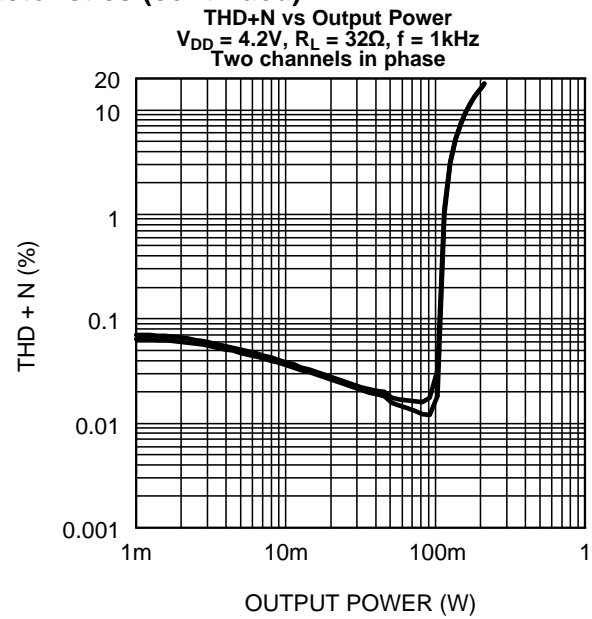

Figure 32.

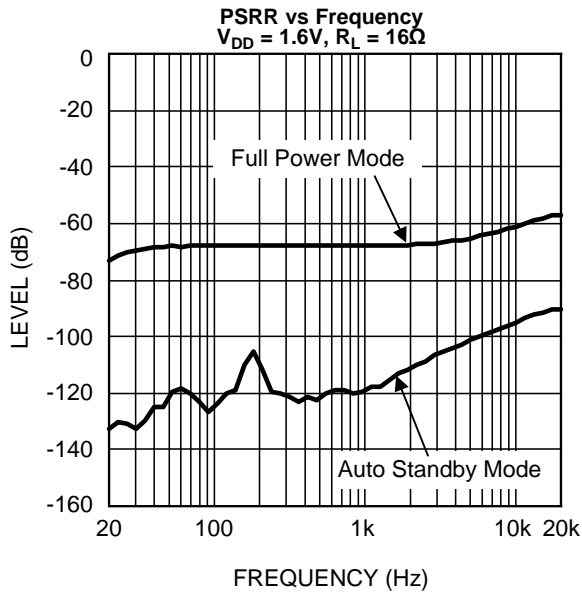

Figure 33.

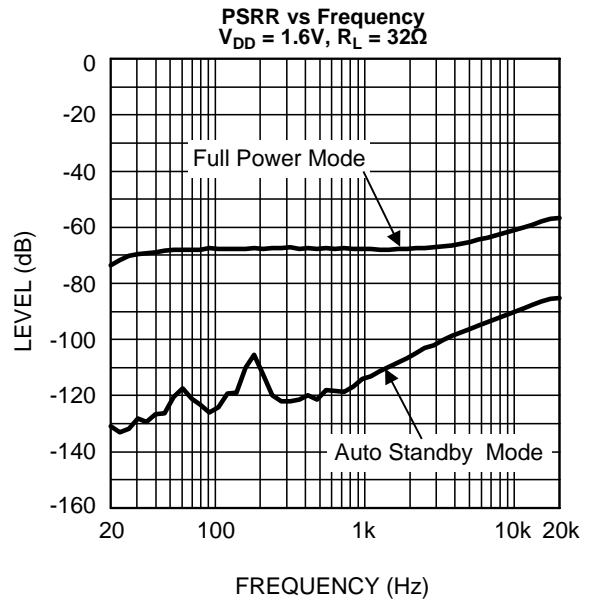

Figure 34.

### Typical Performance Characteristics (continued)

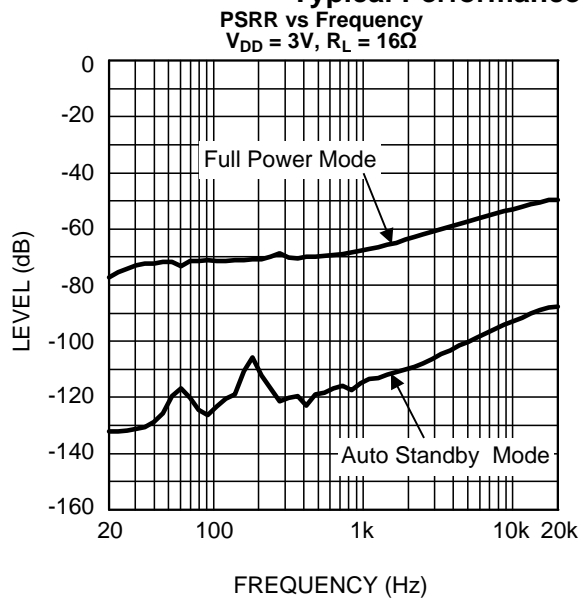

Figure 35.

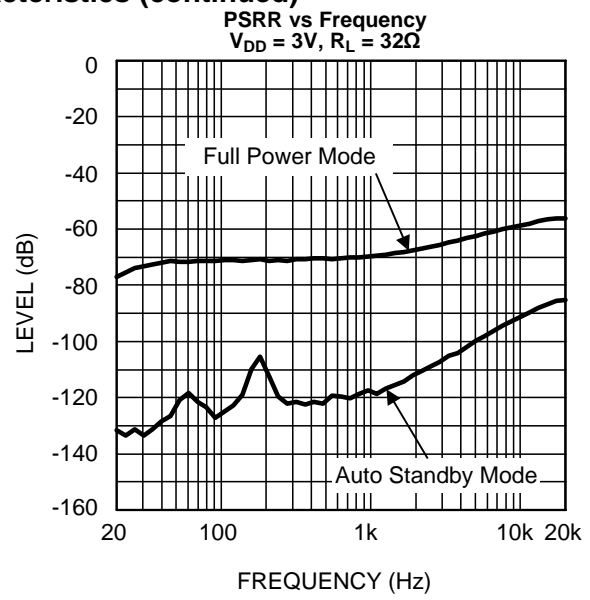

Figure 36.

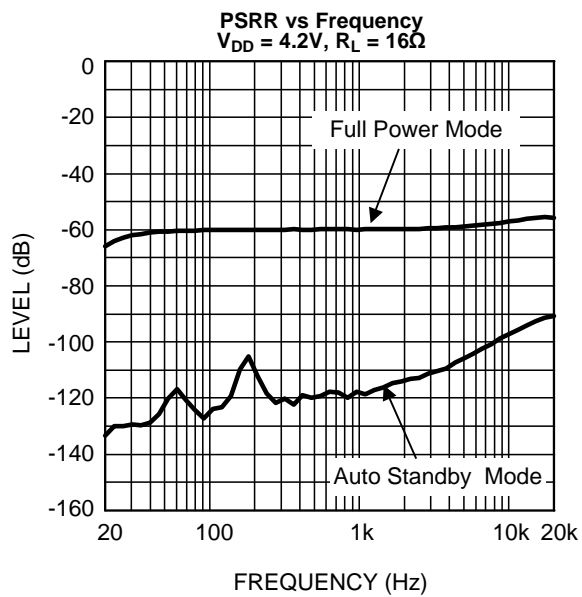

Figure 37.

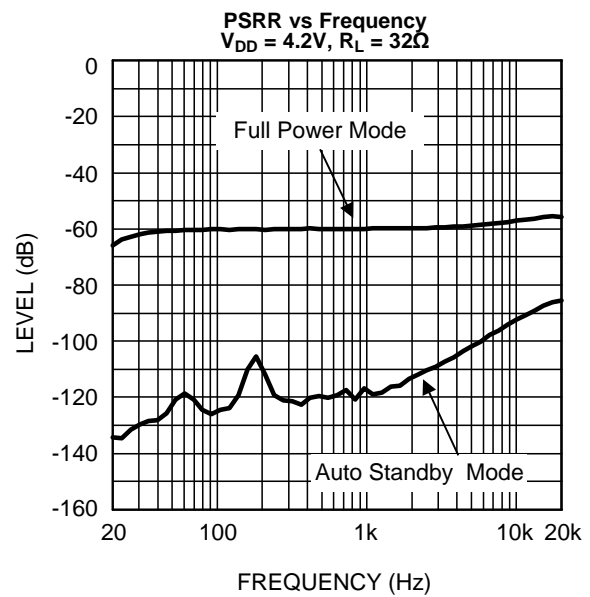

Figure 38.

**Typical Performance Characteristics (continued)**

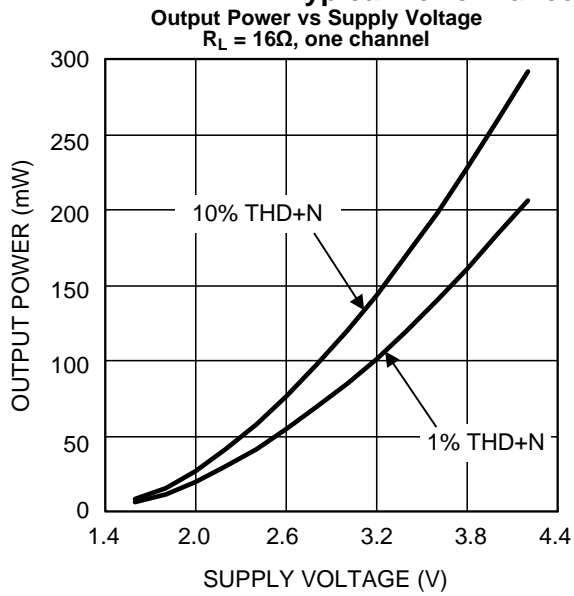

Figure 39.

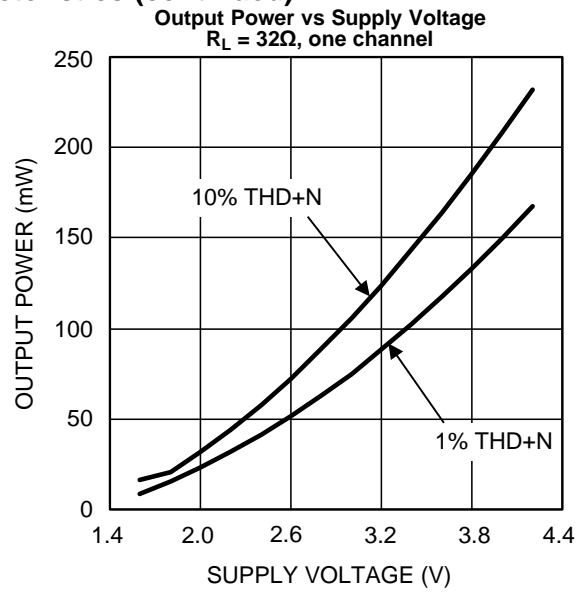

Figure 40.

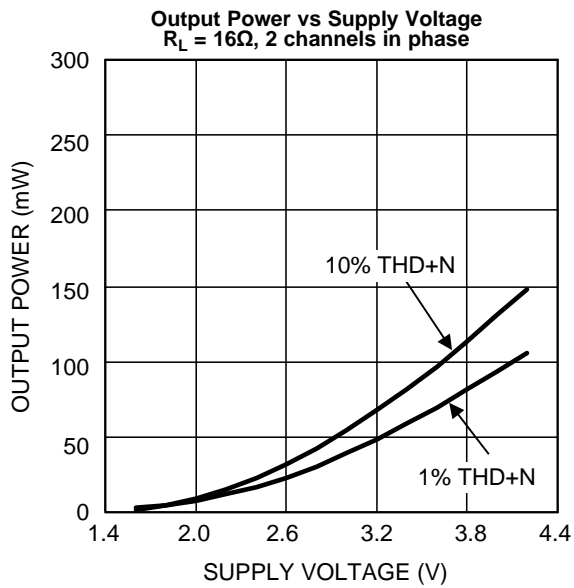

Figure 41.

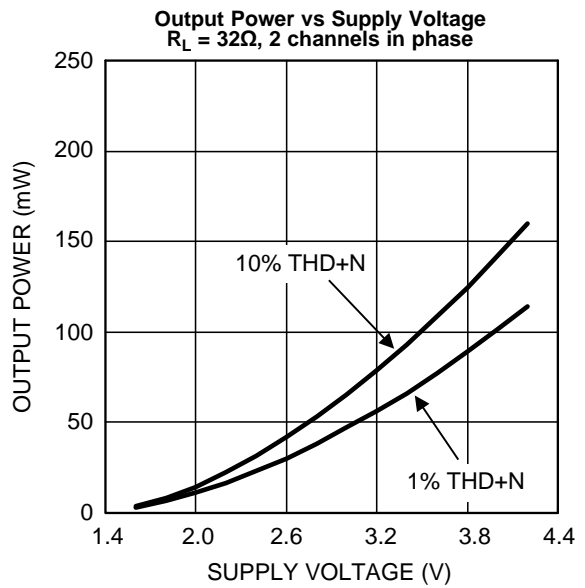

Figure 42.

### Typical Performance Characteristics (continued)

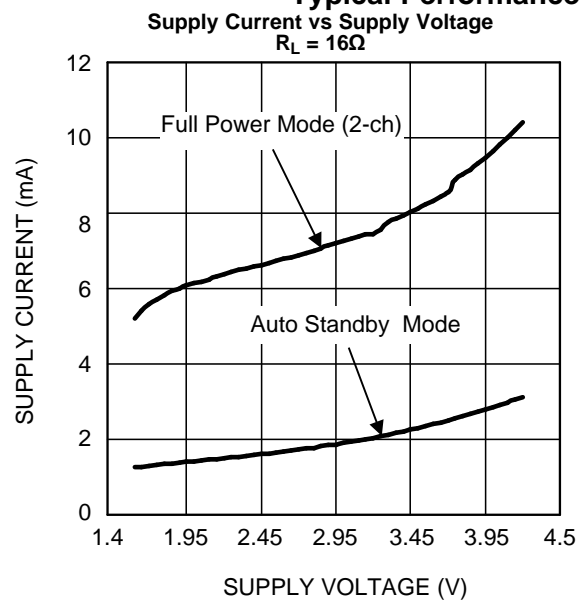

Figure 43.

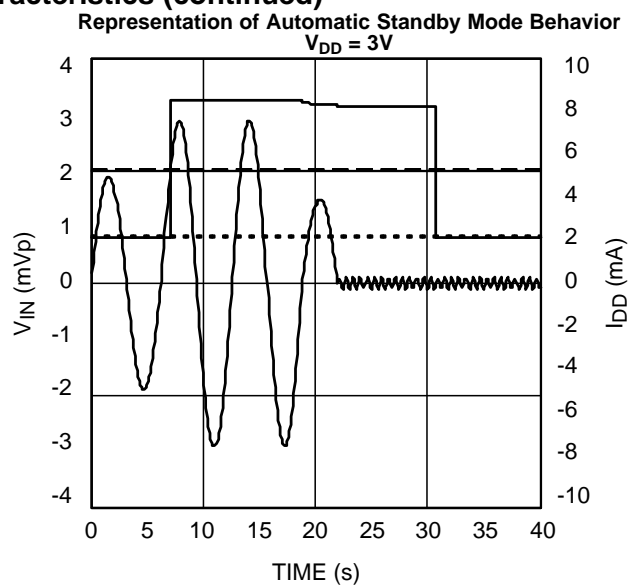

Figure 44.



## APPLICATION INFORMATION

### SUPPLY VOLTAGE SEQUENCING

It is a good general practice to first apply the supply voltage to a CMOS device before any other signal or supply on other pins. This is also true for the LM4922 audio amplifier which is a CMOS device.

Before applying any signal to the inputs or shutdown pins of the LM4922, it is important to apply a supply voltage to the  $V_{DD}$  pins. After the device has been powered, signals may be applied to the shutdown pins (see MICRO POWER SHUTDOWN) and input pins.

### ELIMINATING THE OUTPUT COUPLING CAPACITOR

The LM4922 features a low noise inverting charge pump that generates an internal negative supply voltage. This allows the outputs of the LM4922 to be biased about GND instead of a nominal DC voltage, like traditional headphone amplifiers. Because there is no DC component, the large DC blocking capacitors (typically 220 $\mu$ F) are not necessary. The coupling capacitors are replaced by two, small ceramic charge pump capacitors, saving board space and cost.

Eliminating the output coupling capacitors also improves low frequency response. In traditional headphone amplifiers, the headphone impedance and the output capacitor form a high pass filter that not only blocks the DC component of the output, but also attenuates low frequencies, impacting the bass response. Because the LM4922 does not require the output coupling capacitors, the low frequency response of the device is not degraded by external components.

In addition to eliminating the output coupling capacitors, the ground referenced output nearly doubles the available dynamic range of the LM4922 when compared to a traditional headphone amplifier operating from the same supply voltage.

### OUTPUT TRANSIENT ('CLICK AND POPS') ELIMINATED

The LM4922 contains advanced circuitry that virtually eliminates output transients ('clicks and pops'). This circuitry prevents all traces of transients when the supply voltage is first applied or when the part resumes operation after coming out of shutdown mode.

### AMPLIFIER CONFIGURATION EXPLANATION

As shown in [Figure 1](#), the LM4922 has two internal operational amplifiers. The two amplifiers have internally configured gain, the closed loop gain is set by selecting the ratio of  $R_f$  to  $R_i$ . Consequently, the gain for each channel of the IC is

$$A_v = -(R_f / R_i) = 1.5 \text{ V/V}$$

where

- $R_f = 30\text{k}\Omega$
  - $R_i = 20\text{k}\Omega$
- (1)

Since this is an output ground-referenced amplifier, by driving the headphone through  $R_{OUT}$  (Pin C2) and  $L_{OUT}$  (Pin D2), the LM4922 does not require output coupling capacitors. The typical single-ended amplifier configuration requires large, expensive output capacitors.

### POWER DISSIPATION

Power dissipation is a major concern when using any power amplifier and must be thoroughly understood to ensure a successful design. [Equation 2](#) states the maximum power dissipation point for a single-ended amplifier operating at a given supply voltage and driving a specified output load.

$$P_{DMAX} = (V_{DD})^2 / (2\pi^2 R_L) \quad (2)$$

Since the LM4922 has two operational amplifiers in one package, the maximum internal power dissipation point is twice that of the number which results from [Equation 2](#). Even with large internal power dissipation, the LM4922 does not require heat sinking over a large range of ambient temperatures. From [Equation 2](#), assuming a 3V power supply and a 16 $\Omega$  load, the maximum power dissipation point is 28mW per amplifier. Thus the maximum package dissipation point is 56mW. The maximum power dissipation point obtained must not be greater than the power dissipation that results from [Equation 3](#):

$$P_{DMAX} = (T_{JMAX} - T_A) / (\theta_{JA}) \quad (3)$$

For the DSBGA package,  $\theta_{JA} = 105^\circ\text{C/W}$ .  $T_{JMAX} = 150^\circ\text{C}$  for the LM4922. Depending on the ambient temperature,  $T_A$ , of the system surroundings, Equation 3 can be used to find the maximum internal power dissipation supported by the IC packaging. If the result of Equation 2 is greater than that of Equation 3, then either the supply voltage must be decreased, the load impedance increased or  $T_A$  reduced. For the typical application of a 3V power supply, with a  $16\Omega$  load, the maximum ambient temperature possible without violating the maximum junction temperature is approximately  $144^\circ\text{C}$  provided that device operation is around the maximum power dissipation point. Power dissipation is a function of output power and thus, if typical operation is not around the maximum power dissipation point, the ambient temperature may be increased accordingly.

## POWER SUPPLY BYPASSING

As with any power amplifier, proper supply bypassing is critical for low noise performance and high power supply rejection. Applications that employ a 3V power supply typically use a  $4.7\mu\text{F}$  capacitor in parallel with a  $0.1\mu\text{F}$  ceramic filter capacitor to stabilize the power supply's output, reduce noise on the supply line, and improve the supply's transient response. Keep the length of leads and traces that connect capacitors between the LM4922's power supply pin and ground as short as possible.

## AUTOMATIC STANDBY MODE

The LM4922 features Automatic Standby Mode circuitry (patent pending). In the absence of an input signal, after approximately 12 seconds, the LM4922 goes into low current standby mode. The LM4922 recovers into full power operating mode immediately after a signal, which is greater than the input threshold voltage, is applied to either the left or right input pins. The input threshold voltage is not a static value, as the supply voltage increases, the input threshold voltage decreases. This feature reduces power supply current consumption in battery operated applications. Please see also the graph entitled Representation of Automatic Standby Mode Behavior in the Typical Performance Characteristics section.

To ensure correct operation of Automatic Standby Mode, proper layout techniques should be implemented. Separating PGND and SGND can help reduce noise entering the LM4922 in noisy environments. Auto Standby mode works best when output impedance of the audio source driving LM4922 is equal or less than 50 Ohms. While Automatic Standby Mode reduces power consumption very effectively during silent periods, maximum power saving is achieved by putting the device into shutdown when it is not in use.

## MICRO POWER SHUTDOWN

The voltage applied to the  $\overline{\text{SD\_LC}}$  (shutdown left channel) pin and the  $\overline{\text{SD\_RC}}$  (shutdown right channel) pin controls the LM4922's shutdown function. When active, the LM4922's micropower shutdown feature turns off the amplifiers' bias circuitry, reducing the supply current. The trigger point is 0.45V for a logic-low level, and 1.2V for logic-high level. The low  $0.01\mu\text{A}$  (typ) shutdown current is achieved by applying a voltage that is as near as ground a possible to the  $\overline{\text{SD\_LC}}/\overline{\text{SD\_RC}}$  pins. A voltage that is higher than ground may increase the shutdown current.

There are a few ways to control the micro-power shutdown. These include using a single-pole, single-throw switch, a microprocessor, or a microcontroller. When using a switch, connect an external  $100\text{k}\Omega$  pull-up resistor between the  $\overline{\text{SD\_LC}}/\overline{\text{SD\_RC}}$  pins and  $V_{DD}$ . Connect the switch between the  $\overline{\text{SD\_LC}}/\overline{\text{SD\_RC}}$  pins and ground. Select normal amplifier operation by opening the switch. Closing the switch connects the  $\overline{\text{SD\_LC}}/\overline{\text{SD\_RC}}$  pins to ground, activating micro-power shutdown. The switch and resistor ensure that the  $\overline{\text{SD\_LC}}/\overline{\text{SD\_RC}}$  pins will not float. This prevents unwanted state changes. In a system with a microprocessor or microcontroller, use a digital output to apply the control voltage to the  $\overline{\text{SD\_LC}}/\overline{\text{SD\_RC}}$  pins. Driving the  $\overline{\text{SD\_LC}}/\overline{\text{SD\_RC}}$  pins with active circuitry eliminates the pull-up resistor.

## SELECTING PROPER EXTERNAL COMPONENTS

Optimizing the LM4922's performance requires properly selecting external components. Though the LM4922 operates well when using external components with wide tolerances, best performance is achieved by optimizing component values.

### Charge Pump Capacitor Selection

Use low ESR (equivalent series resistance) (<100mΩ) ceramic capacitors with an X7R dielectric for best performance. Low ESR capacitors keep the charge pump output impedance to a minimum, extending the headroom on the negative supply. Higher ESR capacitors result in reduced output power from the audio amplifiers.

Charge pump load regulation and output impedance are affected by the value of the flying capacitor (C1). A larger valued C1 (up to 3.3uF) improves load regulation and minimizes charge pump output resistance. Beyond 3.3uF, the switch-on resistance dominates the output impedance for capacitor values above 2.2uF.

The output ripple is affected by the value and ESR of the output capacitor (C2). Larger capacitors reduce output ripple on the negative power supply. Lower ESR capacitors minimize the output ripple and reduce the output impedance of the charge pump.

The LM4922 charge pump design is optimized for 2.2uF, low ESR, ceramic, flying, and output capacitors.

### Input Capacitor Value Selection

Amplifying the lowest audio frequencies requires high value input coupling capacitors (C<sub>i</sub> in [Figure 1](#)). A high value capacitor can be expensive and may compromise space efficiency in portable designs. In many cases, however, the speakers used in portable systems, whether internal or external, have little ability to reproduce signals below 150Hz. Applications using speakers with this limited frequency response reap little improvement by using high value input and output capacitors.

Besides affecting system cost and size, C<sub>i</sub> has an effect on the LM4922's click and pop performance. The magnitude of the pop is directly proportional to the input capacitor's size. Thus, pops can be minimized by selecting an input capacitor value that is no higher than necessary to meet the desired -3dB frequency.

As shown in [Figure 1](#), the internal input resistor, R<sub>i</sub> and the input capacitor, C<sub>i</sub>, produce a -3dB high pass filter cutoff frequency that is found using [Equation 4](#). Conventional headphone amplifiers require output capacitors; [Equation 4](#) can be used, along with the value of R<sub>L</sub>, to determine towards the value of output capacitor needed to produce a -3dB high pass filter cutoff frequency.

$$f_{i-3dB} = 1 / 2\pi R_i C_i \quad (4)$$

Also, careful consideration must be taken in selecting a certain type of capacitor to be used in the system. Different types of capacitors (tantalum, electrolytic, ceramic) have unique performance characteristics and may affect overall system performance. (See the section entitled Charge Pump Capacitor Selection.)

LM4922 DSBGA DEMO BOARD ARTWORK

Top Layer

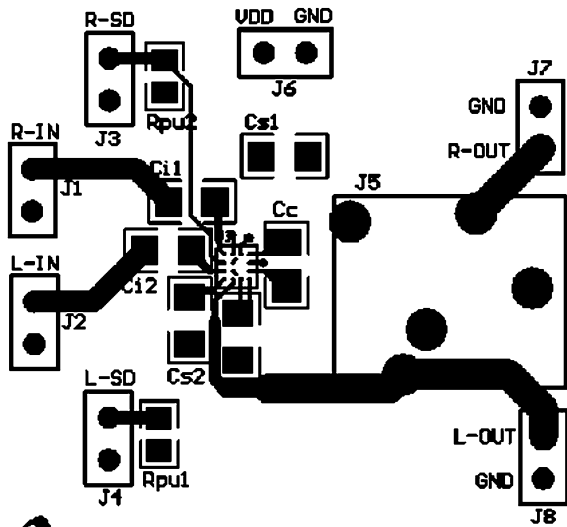

NATIONAL SEMICONDUCTOR  
LM4922TL Audio Power Amplifier

Mid Layer 1

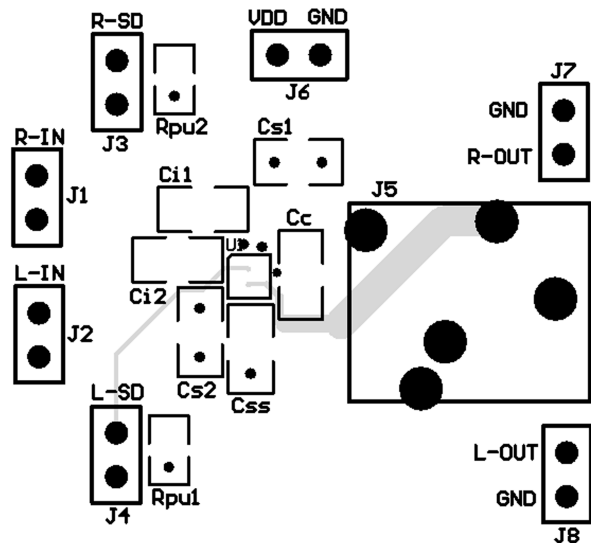

NATIONAL SEMICONDUCTOR  
LM4922TL Audio Power Amplifier

Mid Layer 2

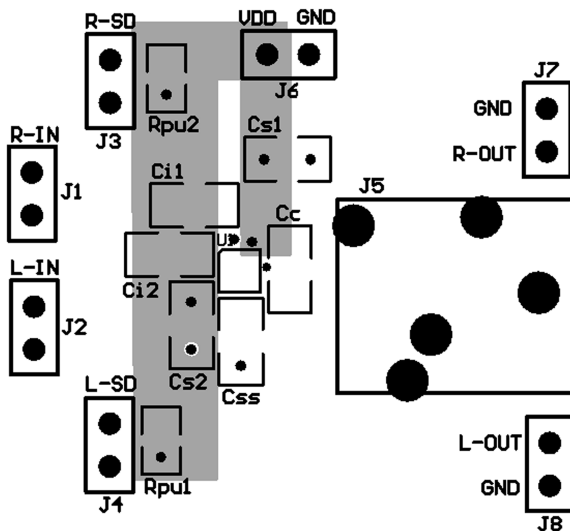

NATIONAL SEMICONDUCTOR  
LM4922TL Audio Power Amplifier

Bottom Layer

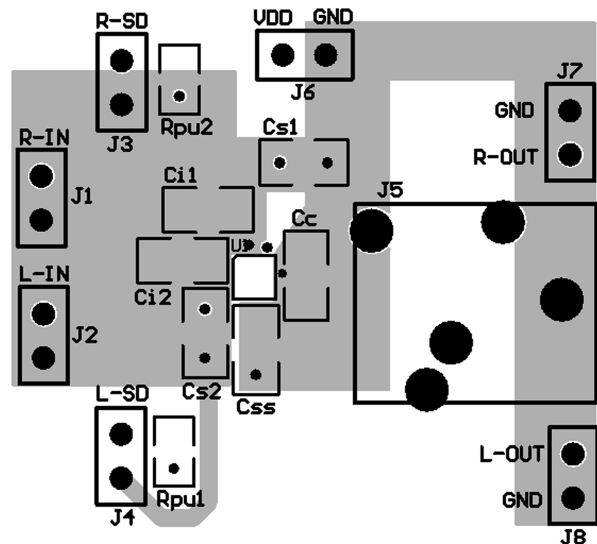

NATIONAL SEMICONDUCTOR  
LM4922TL Audio Power Amplifier

**REVISION HISTORY**

<b>Rev</b>	<b>Date</b>	<b>Description</b>
1.0	11/16/05	Initial release.
1.1	11/18/06	Text edits.
E	04/05/13	Changed layout of National Data Sheet to TI format.

**PACKAGING INFORMATION**

Orderable Device	Status (1)	Package Type	Package Drawing	Pins	Package Qty	Eco Plan (2)	Lead/Ball Finish	MSL Peak Temp (3)	Op Temp (°C)	Top-Side Markings (4)	Samples
LM4922TL/NOPB	NRND	DSBGA	YZE	14	250	Green (RoHS & no Sb/Br)	SNAGCU	Level-1-260C-UNLIM		GG1	
LM4922TLX/NOPB	NRND	DSBGA	YZE	14	3000	Green (RoHS & no Sb/Br)	SNAGCU	Level-1-260C-UNLIM		GG1	

(1) The marketing status values are defined as follows:

**ACTIVE:** Product device recommended for new designs.

**LIFEBUY:** TI has announced that the device will be discontinued, and a lifetime-buy period is in effect.

**NRND:** Not recommended for new designs. Device is in production to support existing customers, but TI does not recommend using this part in a new design.

**PREVIEW:** Device has been announced but is not in production. Samples may or may not be available.

**OBSOLETE:** TI has discontinued the production of the device.

(2) Eco Plan - The planned eco-friendly classification: Pb-Free (RoHS), Pb-Free (RoHS Exempt), or Green (RoHS & no Sb/Br) - please check <http://www.ti.com/productcontent> for the latest availability information and additional product content details.

**TBD:** The Pb-Free/Green conversion plan has not been defined.

**Pb-Free (RoHS):** TI's terms "Lead-Free" or "Pb-Free" mean semiconductor products that are compatible with the current RoHS requirements for all 6 substances, including the requirement that lead not exceed 0.1% by weight in homogeneous materials. Where designed to be soldered at high temperatures, TI Pb-Free products are suitable for use in specified lead-free processes.

**Pb-Free (RoHS Exempt):** This component has a RoHS exemption for either 1) lead-based flip-chip solder bumps used between the die and package, or 2) lead-based die adhesive used between the die and leadframe. The component is otherwise considered Pb-Free (RoHS compatible) as defined above.

**Green (RoHS & no Sb/Br):** TI defines "Green" to mean Pb-Free (RoHS compatible), and free of Bromine (Br) and Antimony (Sb) based flame retardants (Br or Sb do not exceed 0.1% by weight in homogeneous material)

(3) MSL, Peak Temp. -- The Moisture Sensitivity Level rating according to the JEDEC industry standard classifications, and peak solder temperature.

(4) Multiple Top-Side Markings will be inside parentheses. Only one Top-Side Marking contained in parentheses and separated by a "~" will appear on a device. If a line is indented then it is a continuation of the previous line and the two combined represent the entire Top-Side Marking for that device.

**Important Information and Disclaimer:** The information provided on this page represents TI's knowledge and belief as of the date that it is provided. TI bases its knowledge and belief on information provided by third parties, and makes no representation or warranty as to the accuracy of such information. Efforts are underway to better integrate information from third parties. TI has taken and continues to take reasonable steps to provide representative and accurate information but may not have conducted destructive testing or chemical analysis on incoming materials and chemicals. TI and TI suppliers consider certain information to be proprietary, and thus CAS numbers and other limited information may not be available for release.

In no event shall TI's liability arising out of such information exceed the total purchase price of the TI part(s) at issue in this document sold by TI to Customer on an annual basis.

## TAPE AND REEL INFORMATION



### QUADRANT ASSIGNMENTS FOR PIN 1 ORIENTATION IN TAPE



\*All dimensions are nominal

Device	Package Type	Package Drawing	Pins	SPQ	Reel Diameter (mm)	Reel Width W1 (mm)	A0 (mm)	B0 (mm)	K0 (mm)	P1 (mm)	W (mm)	Pin1 Quadrant
LM4922TL/NOPB	DSBGA	YZE	14	250	178.0	8.4	2.18	2.18	0.76	4.0	8.0	Q1
LM4922TLX/NOPB	DSBGA	YZE	14	3000	178.0	8.4	2.18	2.18	0.76	4.0	8.0	Q1

**TAPE AND REEL BOX DIMENSIONS**

\*All dimensions are nominal

Device	Package Type	Package Drawing	Pins	SPQ	Length (mm)	Width (mm)	Height (mm)
LM4922TL/NOPB	DSBGA	YZE	14	250	210.0	185.0	35.0
LM4922TLX/NOPB	DSBGA	YZE	14	3000	210.0	185.0	35.0



YZE0014

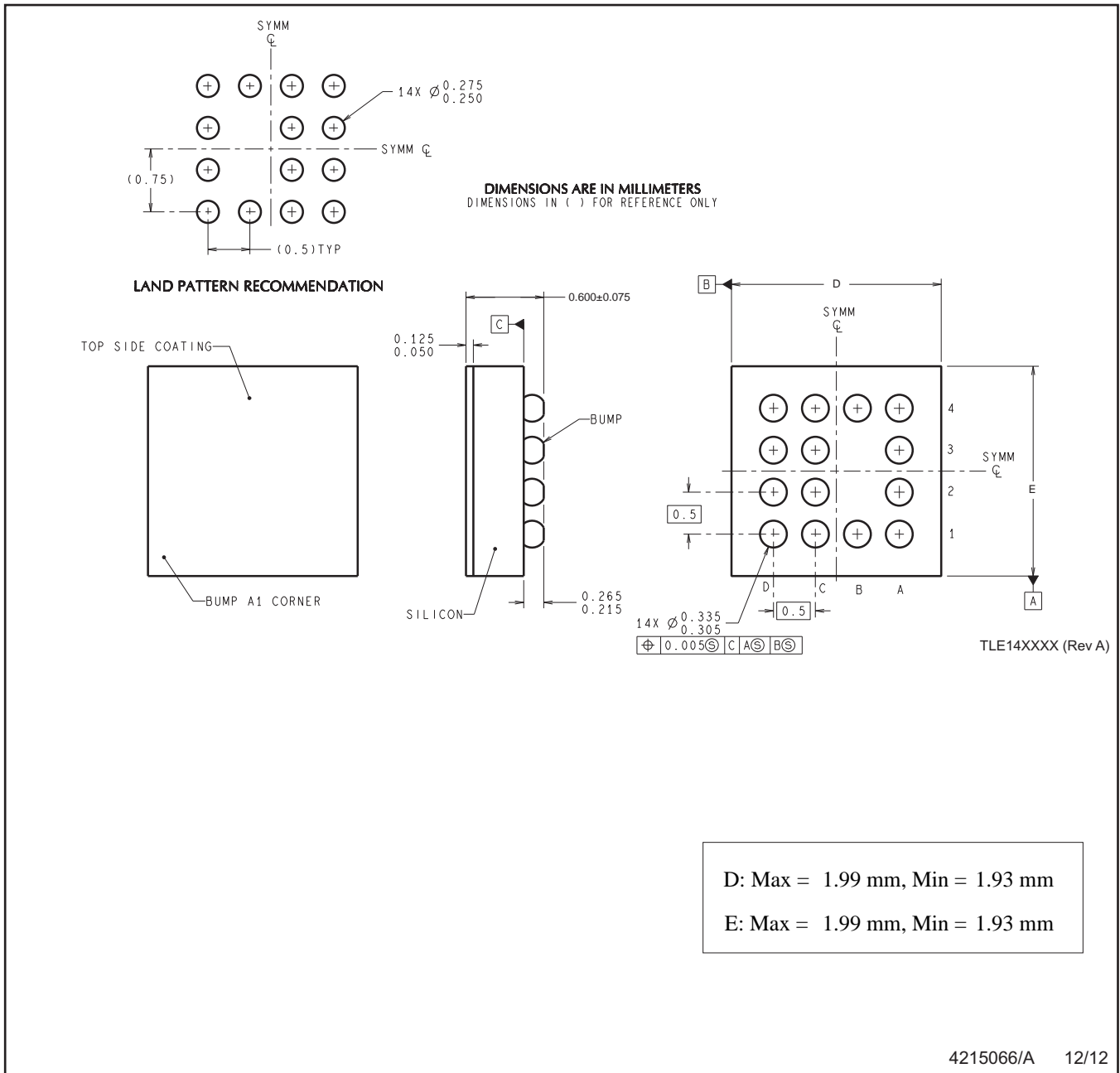

NOTES: A. All linear dimensions are in millimeters. Dimensioning and tolerancing per ASME Y14.5M-1994.  
 B. This drawing is subject to change without notice.

## IMPORTANT NOTICE

Texas Instruments Incorporated and its subsidiaries (TI) reserve the right to make corrections, enhancements, improvements and other changes to its semiconductor products and services per JESD46, latest issue, and to discontinue any product or service per JESD48, latest issue. Buyers should obtain the latest relevant information before placing orders and should verify that such information is current and complete. All semiconductor products (also referred to herein as "components") are sold subject to TI's terms and conditions of sale supplied at the time of order acknowledgment.

TI warrants performance of its components to the specifications applicable at the time of sale, in accordance with the warranty in TI's terms and conditions of sale of semiconductor products. Testing and other quality control techniques are used to the extent TI deems necessary to support this warranty. Except where mandated by applicable law, testing of all parameters of each component is not necessarily performed.

TI assumes no liability for applications assistance or the design of Buyers' products. Buyers are responsible for their products and applications using TI components. To minimize the risks associated with Buyers' products and applications, Buyers should provide adequate design and operating safeguards.

TI does not warrant or represent that any license, either express or implied, is granted under any patent right, copyright, mask work right, or other intellectual property right relating to any combination, machine, or process in which TI components or services are used. Information published by TI regarding third-party products or services does not constitute a license to use such products or services or a warranty or endorsement thereof. Use of such information may require a license from a third party under the patents or other intellectual property of the third party, or a license from TI under the patents or other intellectual property of TI.

Reproduction of significant portions of TI information in TI data books or data sheets is permissible only if reproduction is without alteration and is accompanied by all associated warranties, conditions, limitations, and notices. TI is not responsible or liable for such altered documentation. Information of third parties may be subject to additional restrictions.

Resale of TI components or services with statements different from or beyond the parameters stated by TI for that component or service voids all express and any implied warranties for the associated TI component or service and is an unfair and deceptive business practice. TI is not responsible or liable for any such statements.

Buyer acknowledges and agrees that it is solely responsible for compliance with all legal, regulatory and safety-related requirements concerning its products, and any use of TI components in its applications, notwithstanding any applications-related information or support that may be provided by TI. Buyer represents and agrees that it has all the necessary expertise to create and implement safeguards which anticipate dangerous consequences of failures, monitor failures and their consequences, lessen the likelihood of failures that might cause harm and take appropriate remedial actions. Buyer will fully indemnify TI and its representatives against any damages arising out of the use of any TI components in safety-critical applications.

In some cases, TI components may be promoted specifically to facilitate safety-related applications. With such components, TI's goal is to help enable customers to design and create their own end-product solutions that meet applicable functional safety standards and requirements. Nonetheless, such components are subject to these terms.

No TI components are authorized for use in FDA Class III (or similar life-critical medical equipment) unless authorized officers of the parties have executed a special agreement specifically governing such use.

Only those TI components which TI has specifically designated as military grade or "enhanced plastic" are designed and intended for use in military/aerospace applications or environments. Buyer acknowledges and agrees that any military or aerospace use of TI components which have **not** been so designated is solely at the Buyer's risk, and that Buyer is solely responsible for compliance with all legal and regulatory requirements in connection with such use.

TI has specifically designated certain components as meeting ISO/TS16949 requirements, mainly for automotive use. In any case of use of non-designated products, TI will not be responsible for any failure to meet ISO/TS16949.

### Products

Audio	<a href="http://www.ti.com/audio">www.ti.com/audio</a>
Amplifiers	<a href="http://amplifier.ti.com">amplifier.ti.com</a>
Data Converters	<a href="http://dataconverter.ti.com">dataconverter.ti.com</a>
DLP® Products	<a href="http://www.dlp.com">www.dlp.com</a>
DSP	<a href="http://dsp.ti.com">dsp.ti.com</a>
Clocks and Timers	<a href="http://www.ti.com/clocks">www.ti.com/clocks</a>
Interface	<a href="http://interface.ti.com">interface.ti.com</a>
Logic	<a href="http://logic.ti.com">logic.ti.com</a>
Power Mgmt	<a href="http://power.ti.com">power.ti.com</a>
Microcontrollers	<a href="http://microcontroller.ti.com">microcontroller.ti.com</a>
RFID	<a href="http://www.ti-rfid.com">www.ti-rfid.com</a>
OMAP Applications Processors	<a href="http://www.ti.com/omap">www.ti.com/omap</a>
Wireless Connectivity	<a href="http://www.ti.com/wirelessconnectivity">www.ti.com/wirelessconnectivity</a>

### Applications

Automotive and Transportation	<a href="http://www.ti.com/automotive">www.ti.com/automotive</a>
Communications and Telecom	<a href="http://www.ti.com/communications">www.ti.com/communications</a>
Computers and Peripherals	<a href="http://www.ti.com/computers">www.ti.com/computers</a>
Consumer Electronics	<a href="http://www.ti.com/consumer-apps">www.ti.com/consumer-apps</a>
Energy and Lighting	<a href="http://www.ti.com/energy">www.ti.com/energy</a>
Industrial	<a href="http://www.ti.com/industrial">www.ti.com/industrial</a>
Medical	<a href="http://www.ti.com/medical">www.ti.com/medical</a>
Security	<a href="http://www.ti.com/security">www.ti.com/security</a>
Space, Avionics and Defense	<a href="http://www.ti.com/space-avionics-defense">www.ti.com/space-avionics-defense</a>
Video and Imaging	<a href="http://www.ti.com/video">www.ti.com/video</a>

### TI E2E Community

[e2e.ti.com](http://e2e.ti.com)