

### General Description

The PVI Photovoltaic Isolator generates an electrically isolated DC voltage upon receipt of a DC input signal. The input of the PVI is a light-emitting diode (LED) which is optically coupled to, but electrically isolated from, the output. A GaAlAs LED is used for high output and maximum stability. The infrared emission from the LED energizes, by photovoltaic action, a series connection of silicon PN junctions. A unique alloyed junction stack which is edge-illuminated is used to form the output photovoltaic generators. This novel structure produces extremely high operating efficiency. Units are available with a single 5-volt output or dual 5-volt outputs which can be series connected to produce 10 volts.

A PVI can serve as an isolator, a coupler and as an isolated voltage source. As an isolator, the PVI can serve as the key component in a solid state relay circuits. The PVI is ideally suited for driving power MOSFETs and IGBTs or sensitive gate SCRs to form solid state relays.

As a coupler, the PVI can sense a low-level DC signal and transmit a voltage signal to an electrically remote circuit. As a voltage source, the PVI can function as a 'DC transformer' by providing an isolated, low-current DC source for biasing or supplying power to low quiescent current electronic devices.

Conventional optocouplers merely modulate the resistance of an output device such as a transistor, diode or resistor. Such optocouplers require a separate voltage source to detect the presence of an input signal. In contrast, a PVI actually transmits (and transforms) energy across the isolation barrier and directly generates an output voltage. This DC voltage, available at a 2500VAC isolation level, gives circuit designers a new and uniquely useful electronic component.

### Features

- Isolated Voltage Source ■
- MOSFET Driver ■
- Up to 10 $\mu$ A Output ■
- Fast Response ■
- GaAlAs LED ■
- 2500V (RMS) Isolation ■
- 8-pin DIP Package ■
- Single or Dual Output ■

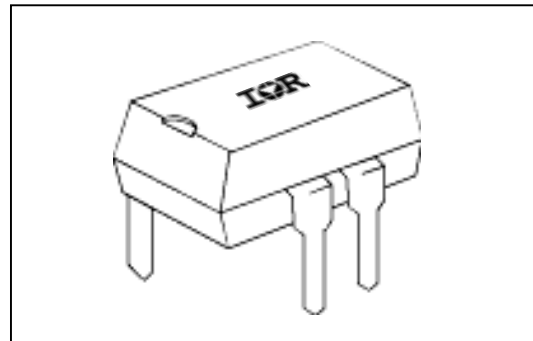

### Part Identification

Part Number	Outputs	Output Voltage	Output Current
PVI5050	1	5.0V	5 $\mu$ A
PVI5080	1	5.0V	8 $\mu$ A
PVI1050	2	5.0/10.0V	10/5 $\mu$ A

**Electrical Specifications** ( $-40^{\circ}\text{C} \leq T_A \leq +85^{\circ}\text{C}$  unless otherwise specified)

INPUT CHARACTERISTICS	PVI Series	Units
Input Current Range (see figure 6)	2.0 to 50	mA (DC)
Maximum Forward Voltage Drop @ 10mA, 25°C (see figure 7)	1.4	V (DC)
Maximum Reverse Voltage	7.0	V(DC)
Maximum Reverse Current @ -7.0V (DC), 25°C	100	$\mu\text{A(DC)}$
Maximum Pulsed Input Current @ 25°C (see figure 8)	1.0	A(peak)

OUTPUT CHARACTERISTICS	PVI Series	Units
Maximum Forward Voltage @ 10 $\mu\text{A}$	8.0 per channel	$V_{(DC)}$
Maximum Reverse Current @ -10VDC	10	$\mu\text{A(DC)}$

COUPLED CHARACTERISTICS	PVI5050	PVI5080	PVI1050	Units	
Minimum Open Circuit Voltage @ 10mA, 25°C (see figures 1 to 4)	5.0V		5.0V/channel 10V series	V (DC)	
Minimum Short Circuit Current @ 10mA, 25°C (see figures 1 to 3)	5 $\mu\text{A}$	8 $\mu\text{A}$	5.0 $\mu\text{A}$ /channel 10 $\mu\text{A}$ parallel	$\mu\text{A (DC)}$	
Maximum Capacitance (Input/Output)	1.0		2.0	pF	
Maximum Turn-On Time @ 20mA Input, 25°C (see figure 9)	$R_L=5.0\text{M}\Omega$	30	30	30	$\mu\text{s}$
	$R_L=1.0\text{M}\Omega$	40	40	40	$\mu\text{s}$
Maximum Turn-Off Time @ 20mA Input, 25°C (see figure 9)	$R_L=5.0\text{M}\Omega$	400	400	400	$\mu\text{s}$
	$R_L=1.0\text{M}\Omega$	100	100	100	$\mu\text{s}$
Insulation Resistance @ 90VDC (Input/Output)	$10^{12}$			$\Omega$	
Dielectric Strength	Input/Output	2500		V(RMS)	
	Between Outputs	N/A		1200 V(DC)	

GENERAL CHARACTERISTICS	PVI Series	Units
Ambient Temperature Range	Operating	-40 to +100
	Storage	-40 to +100
Maximum Lead Temperature (1.6mm below seating plane for 10 seconds)	280	$^{\circ}\text{C}$

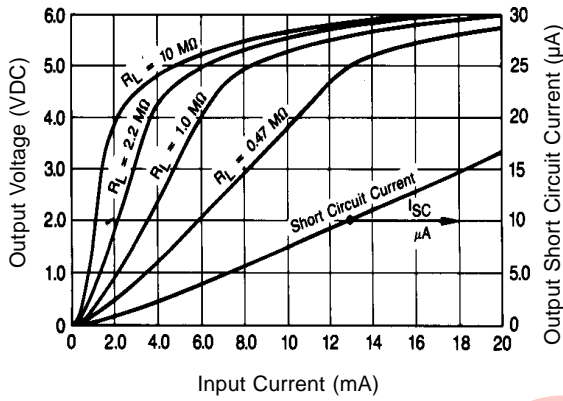

Figure 1. PVI5050 Typical Output Characteristics

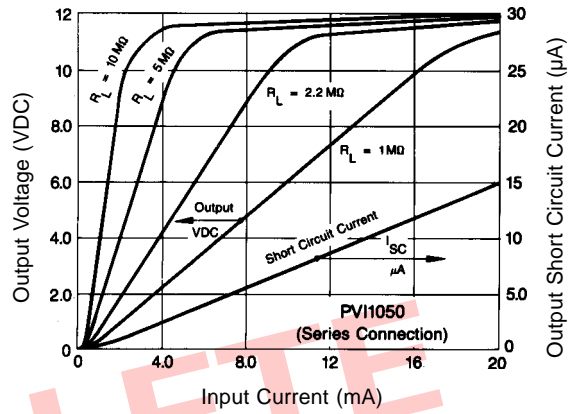

Figure 2. PVI1050 Typical Output Characteristics

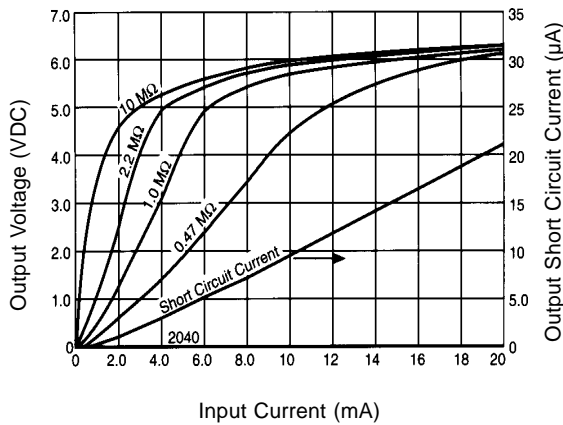

Figure 3. PVI5080 Typical Output Characteristics

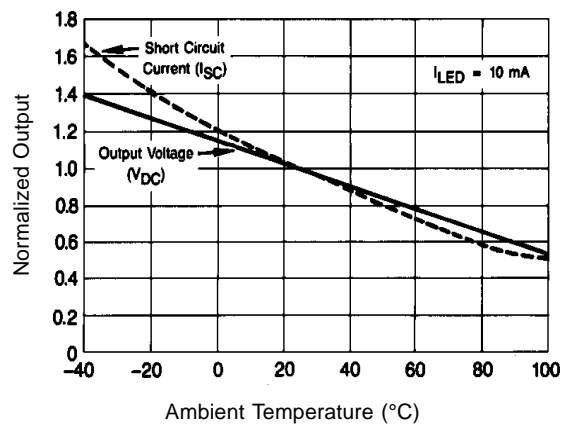

Figure 4. Typical Variation of Output

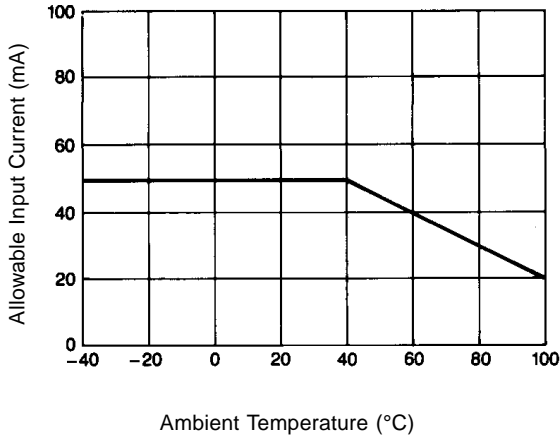

Figure 6. Input Current Derating

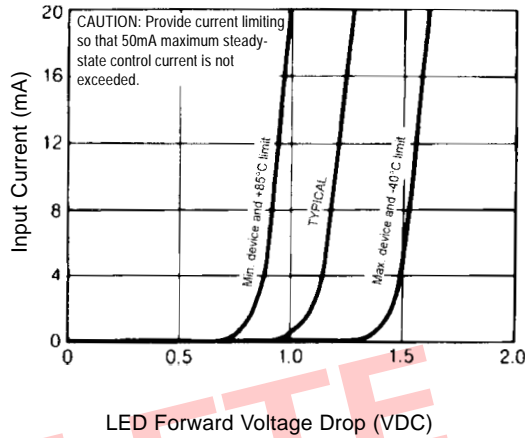

Figure 7. Input Characteristics

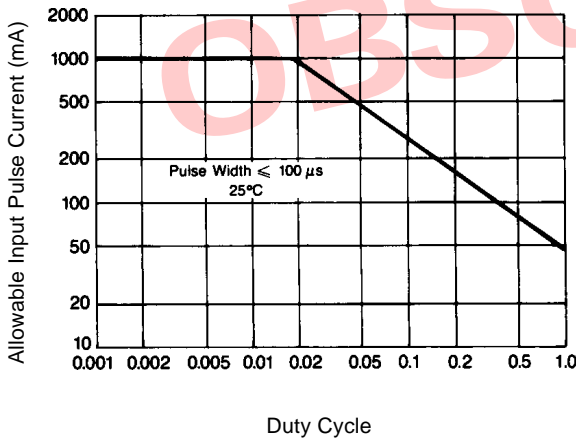

Figure 8. Input Pulse Capability

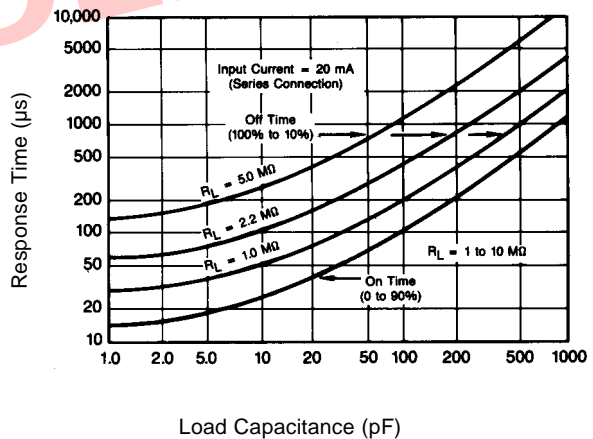
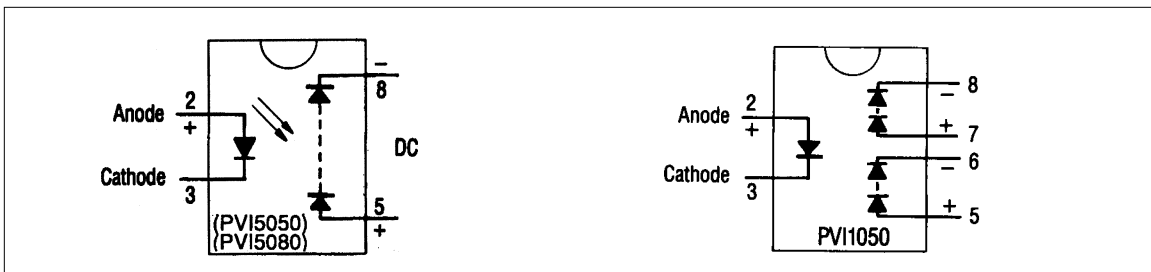

Figure 9. PVI1050 (PVI5050) Typical Response Time

**Wiring Diagram**



**Application Note:**

The outputs of the PVI1050 (pins 5-6 and 7-8) may be placed in series connection to produce a 10-volt output with a 5 $\mu$ A minimum short circuit current. Alternatively, the two outputs of the PVI1050 may be connected in parallel to produce a 5.0-volt output with a 10 $\mu$ A minimum short circuit current.

The two outputs of the PVI1050 may be applied separately with a maximum 1200VDC between the outputs. Input-to-output isolation to either output is 2500V (RMS).

**Case Outline**

