



EV2665A-QB-00A

21V, 1A, Linear Charger for Single-Cell Li-Ion Batteries with Power Management Evaluation Board

DESCRIPTION

The EV2665A-QB-00A is an evaluation board designed to demonstrate the capabilities of the MP2665A, a highly integrated, single-cell Li-ion/Li-polymer battery charger with system power path management. The MP2665A is ideal for space-constrained portable applications. It takes input power from either an AC adapter or a USB port to supply the system load and charge the battery simultaneously. It also features pre-charge, constant current (CC) fast charge, constant voltage (CV) regulation, charge termination, and auto-recharge.

The MP2665A ensures that the system is continuously powered by automatically selecting the input, the battery, or both to power the system.

It provides system short-circuit protection (SCP) to prevent the Li-ion battery from being damaged due to excessively high currents.

The MP2665A also provides an on-chip battery under-voltage lockout (UVLO) threshold that cuts off the path between the battery and the system if the battery voltage drops below the configurable UVLO threshold. This prevents the Li-ion battery from being overly discharged.

The integrated I²C interface can configure the following charging parameters: input current limit, input voltage regulation limit, charging current, battery regulation voltage, safety timer, and battery UVLO threshold. The MP2665A is available in a QFN-12 (2.5mmx3mm) package.

PERFORMANCE SUMMARY

Specifications are at T_A = 25°C, unless otherwise noted.

Parameters	Conditions	Value
Input voltage (V _{IN}) range		4.35V to 5.5V
Battery voltage (V _{BATT})		3.6V to 4.545V
Fast charge current (I _{CC})		16mA to 896mA
Input current limit		50mA to 1000mA
Minimum V _{IN} regulation		3.88V to 5.08V

EVALUATION BOARD

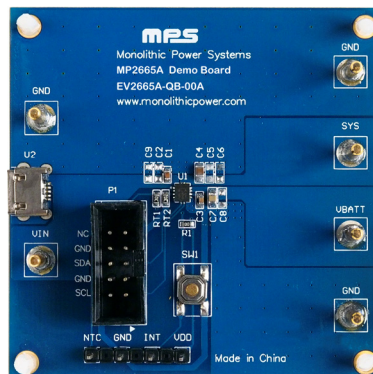

LxWxH (6.3cmx6.3cmx0.16cm)
2 Layers, 1oz/1oz

Board Number	MPS IC Number
EV2665A-QB-00A	MP2665AGQB-xxxx

QUICK START GUIDE

The EV2665A-QB-00A evaluation board is designed to demonstrate the capabilities of the MP2665A, a highly integrated, single-cell Li-ion/Li-polymer battery charger with system power path management. The EV2665A-QB-00A's layout accommodates most commonly used capacitors. The default function of this board is preset for charger mode, and the full-charge voltage is preset to 4.2V for single-cell Li-ion batteries.

Evaluation Platform Preparation:

1. To use the evaluation platform, the following is required: a computer with at least one USB port, a USB cable, and a USB-to-I²C communication kit (EVKT-USBI2C-02) (see Figure 1).



Figure 1: USB-to-I²C Communication Kit

2. The MP2665A programming tool software must also be properly installed. This software can be downloaded from the MPS website.

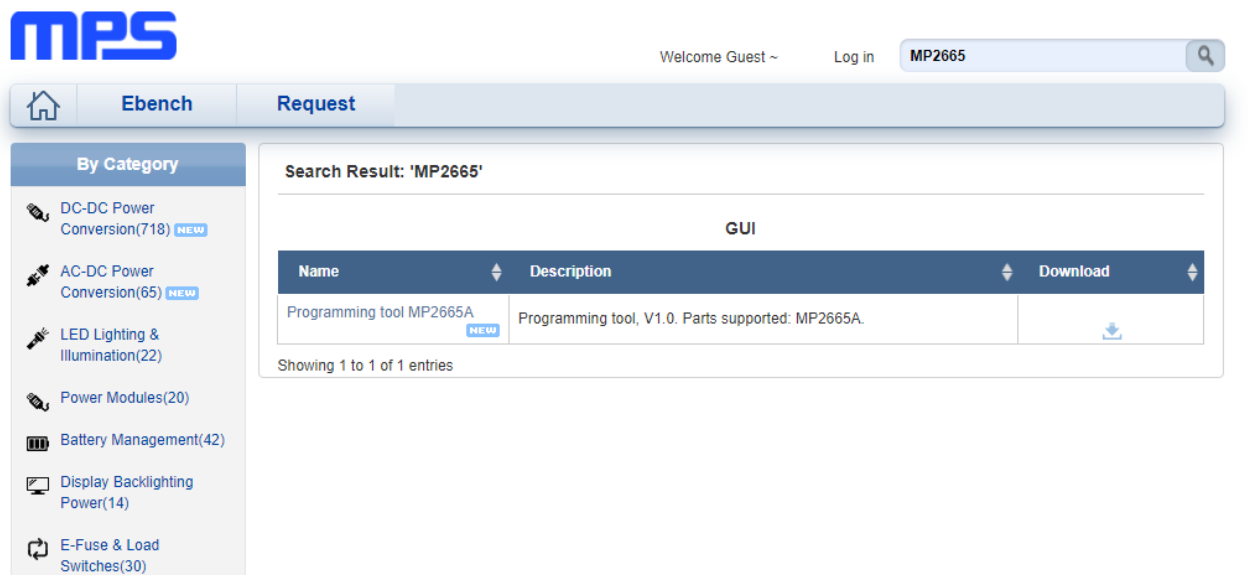

Figure 2: MP2665A Programming Tool on eBench

3. Figure 3 on page 3 shows the original test set-up for the MP2665A.
 - a. Connect the input voltage ($V_{IN} = 5V$) and the input ground to the VIN and GND pins, respectively.
 - b. Connect the load terminals to:
 - Positive (+): SYS
 - Negative (-): GND

c. Connect the battery ($V_{BATT} = 3V$ to $4.2V$) terminals to:

- Positive (+): BATT
- Negative (-): GND

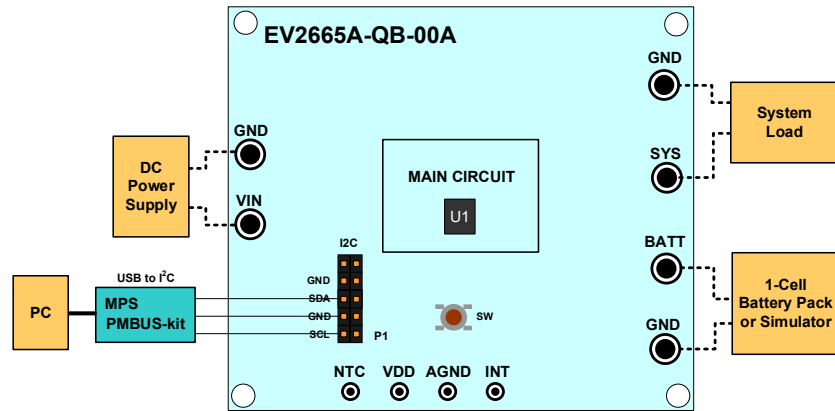

Figure 3: Test Set-Up for the MP2665A

4. Turn on the computer and launch the MP2665A evaluation software. Figure 4 shows the main window of the software.



Figure 4: MP2665A Evaluation Interface

PROCEDURE

Ensure that all the connections (e.g. between the USB-to-I²C communication kit and the EV2665A-QB-00A) are successful.

- Figure 5 shows the default values of the charger function.

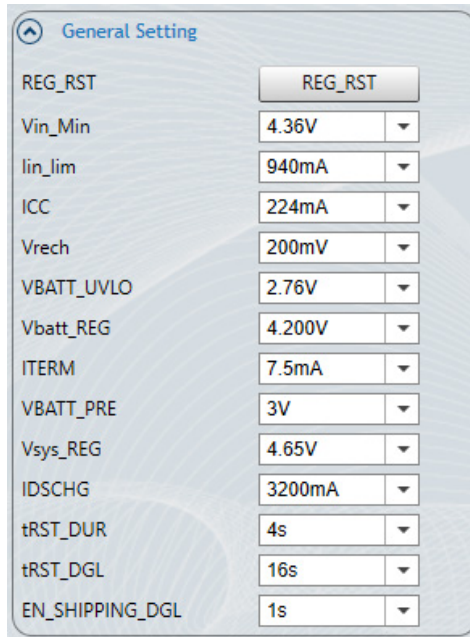

Figure 5: Charger Function

- Figure 6 shows the minimum V_{IN} setting. Set the minimum V_{IN} to 4.36V (the range is 3.88V to 5.08V).

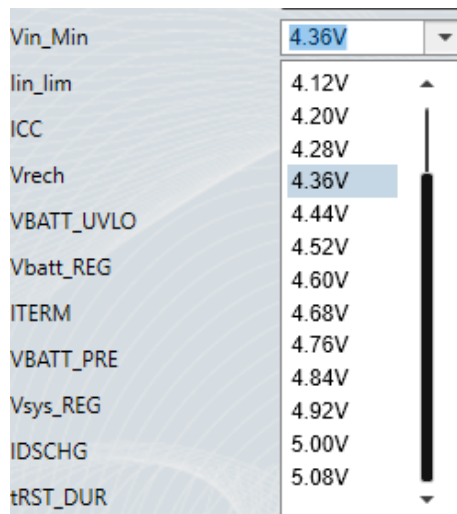

Figure 6: Minimum V_{IN} Setting

- Figure 7 shows the input current limit setting. Set the input current limit to 940mA (the range is 50mA to 1000mA).

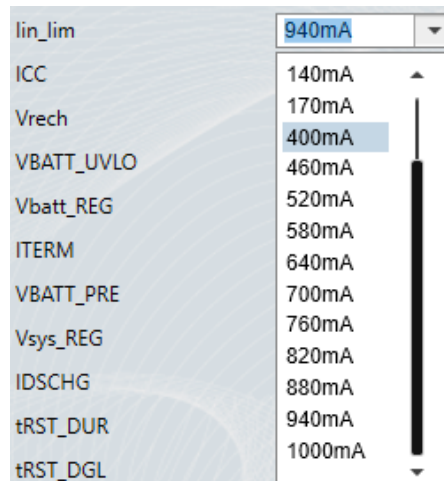

Figure 7: Input Current Limit Setting

- Figure 8 shows the fast charge current setting. Set the fast charge current to 224mA (the range is 16mA to 896mA).

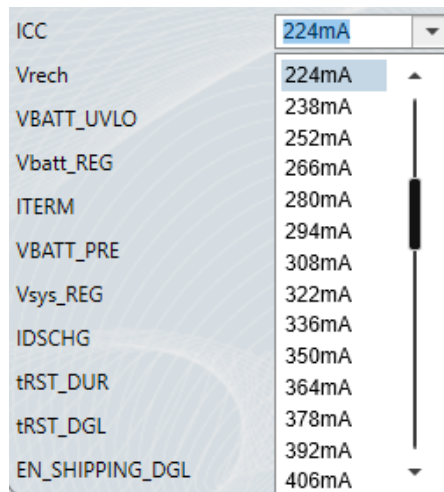

Figure 8: Fast Current Charge Setting

- Figure 9 shows the BATT_UVLO threshold setting. Set the BATT_UVLO threshold to 2.76V (the range is 2.4V to 3.03V).

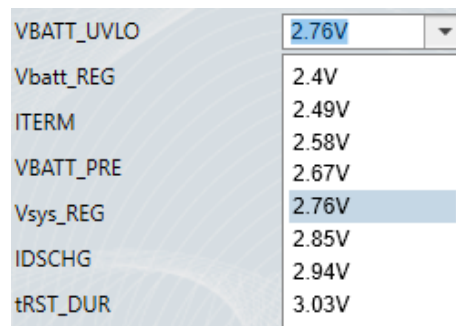

Figure 9: BATT_UVLO Threshold Setting

6. Figure 10 shows the charge termination current setting. Set the charge termination current to 7.5mA (the range is 2.5mA to 62mA).

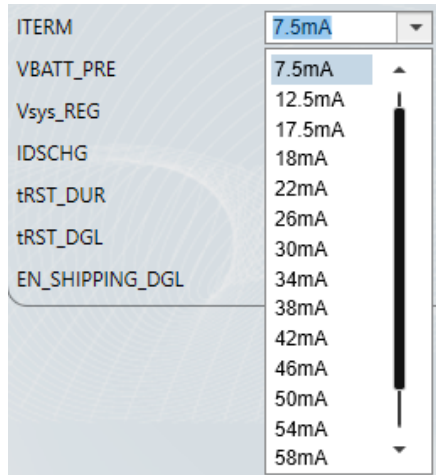

Figure 10: Charge Termination Current Setting

7. Figure 11 shows the battery regulation voltage setting. Set the battery regulation voltage to 4.2V (the range is 3.6V to 4.545V).

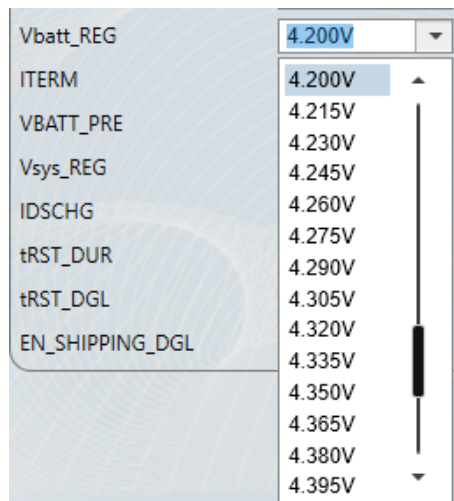

Figure 11: Battery Regulation Voltage Setting

8. Figure 12 shows the pre-charge to fast charge threshold setting. Set the pre-charge to fast charge threshold voltage to 3V (the range is 2.8V to 3V).

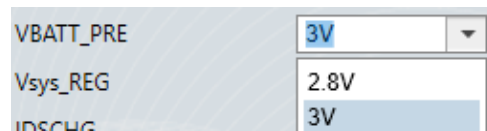

Figure 12: Pre-Charge to Fast Charge Threshold Setting

9. Figure 13 shows the battery auto-recharge voltage setting. Set the battery auto-recharge voltage to VBAT_REG to 200mV (the range is 100mV to 200mV).

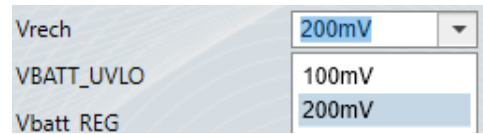

Figure 13: Battery Auto-Recharge Voltage Setting

10. Figure 14 shows the battery discharge current limit. Set the battery discharge current limit to 3200mA (the range is 400mA to 3200mA).

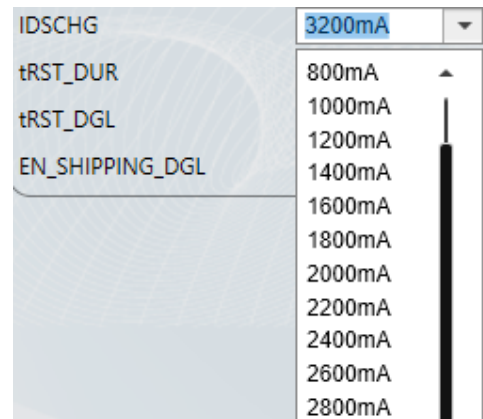

Figure 14: Battery Discharge Current Limit

11. Figure 15 shows the INT control setting.

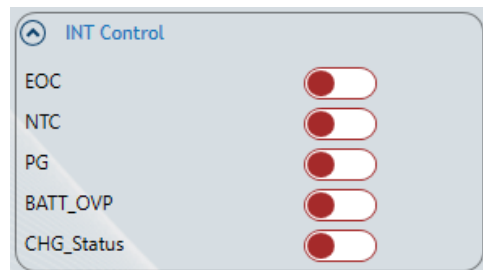

Figure 15: INT Control Setting

12. Figure 16 on page 8 shows the FET control setting.

- a. EN_HIZ controls the low-dropout (LDO) FET's on/off function.
- b. CEB controls the Battery FET's on/off function in charge mode.
- c. Select FET_DIS to turn off the Battery FET in both the charge and discharge modes.
- d. De-selecting FET_DIS cannot turn on the battery FET. Use the push button or plug in the input adapter for 2 seconds to pull INT low, which turns on the battery FET when it is turned off by FET_DIS.

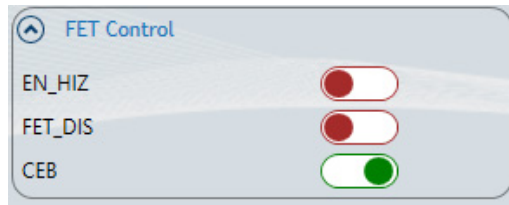

Figure 16: FET Control Setting

13. Figure 17 shows the VIN_LOOP control setting.



Figure 17: VIN_LOOP Control Setting

14. Figure 18 shows the battery FET time setting.



Figure 18: Battery FET Time Setting

15. Figure 19 shows the thermal control setting to enable PCB over-temperature protection (OCP).

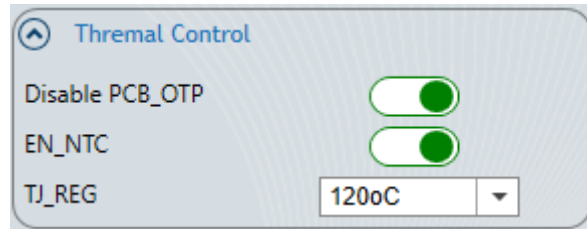

Figure 19: Thermal Control Setting

For other applications, see Table 1 for the NTC function selection.

Table 1: NTC Function Selection

I ² C Control		Function
EN_NTC	EN_PCB OTP	
0	X ⁽¹⁾	Disabled
1	1	NTC
1	0	PCB OTP

Notes:

1) "x" means not applicable.

16. Figure 20 shows the safety timer setting.

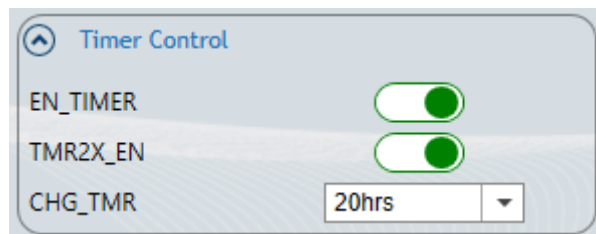

Figure 20: Safety Timer Setting

17. Figure 21 shows the I²C watchdog timer setting.



Figure 21: I²C Watchdog Timer Setting

18. Figure 22 shows the content of the registers.

Command code	Command name	Register Vaule(0x)	Register Vaule(0b)
00H	00H	6E	0110 1110
01H	01H	AC	1010 1100
02H	02H	0F	0000 1111
03H	03H	F1	1111 0001
04H	04H	A3	1010 0011
05H	05H	38	0011 1000
06H	06H	C0	1100 0000
07H	07H	B9	1011 1001
08H	08H	40	0100 0000
09H	09H	00	0000 0000
0AH	0AH	00	0000 0000
0BH	0BH	20	0010 0000

Figure 22: Content of the Registers

19. Figure 23 shows the MP2665A’s operation status and fault report.

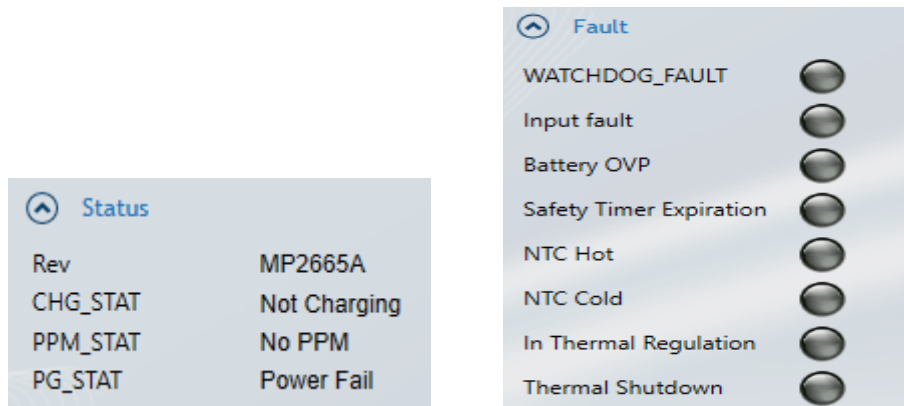

Figure 23: MP2665A Operation Status and Fault Report

EVALUATION BOARD SCHEMATIC

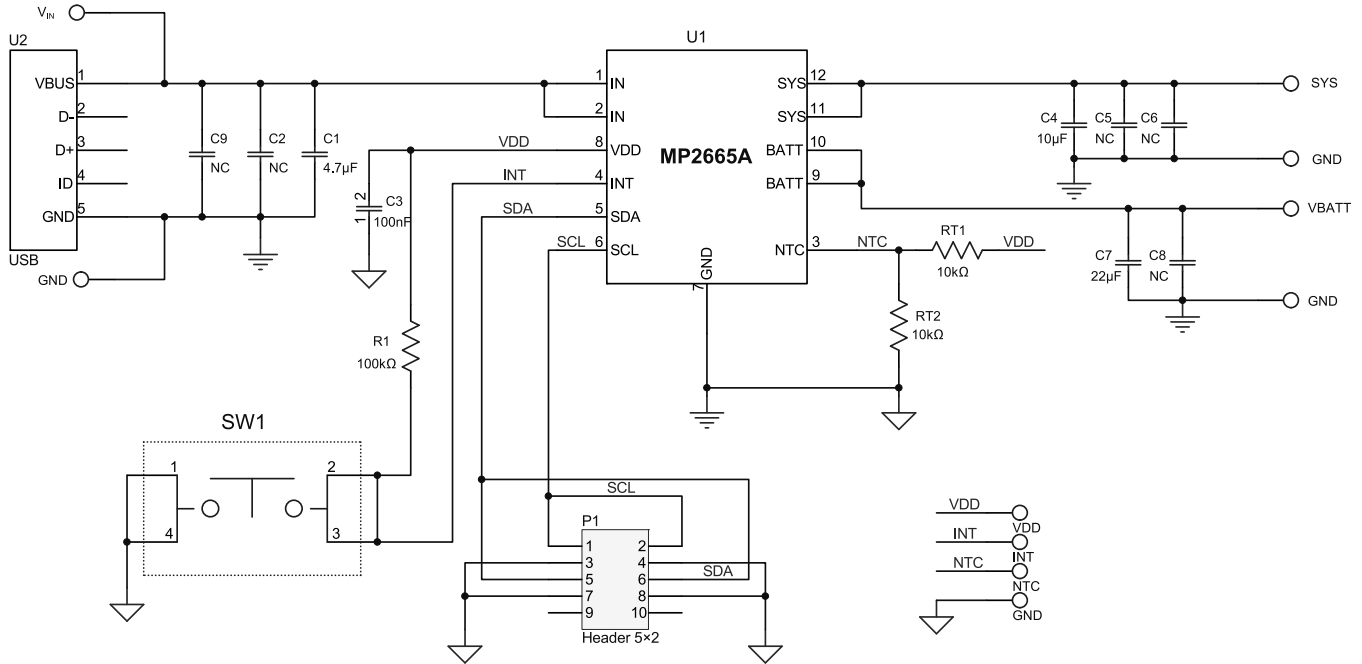

Figure 24: Evaluation Board Schematic

EV2665A-QB-00A BILL OF MATERIALS

Qty	Ref	Value	Description	Package	Manufacturer	Manufacturer PN
1	C1	4.7 μ F	Ceramic capacitor, 25V, X5R	0603	Murata	GRM188R61E475KE11D
2	C2, C9	NC				
1	C3	100nF	Ceramic capacitor, 25V, X7R	0603	Murata	GRM188R71E104KA01D
1	C4	10 μ F	Ceramic capacitor, 16V, X7R	0805	Murata	GRM21BR61C106KE15
1	C5	NC	Ceramic capacitor, 25V, X7R	0805	Murata	GRM21BR71E225KA73L
2	C6, C8	NC	Ceramic capacitor, 16V, X7R	0805	Murata	GRM21BR61C106KE15
1	C7	22 μ F	Ceramic capacitor, 16V, X5R	0805	Murata	GRM21BR61C226ME44L
1	P1	2.54mm	5-pin, dual-row header	DIP	Any	
1	R1	100k Ω	Film resistor, 1%	0603	Yageo	RC0603FR-07100KL
2	RT1, RT2	10k Ω	Film resistor, 1%	0603	Yageo	RC0603FR-0710KL
1	SW1	6.35mmx 8.89mm	Push switch	7914J	Any	
1	U2	6.8mmx 8.23mm	Micro-B USB connector	DIP	Any	
1	U1	MP2665A	1A, single-cell battery charger	QFN-12 (2.5mmx 3mm)	MPS	MP2665AGQB-0000

EVB TEST RESULTS

Performance curves and waveforms are tested on the evaluation board. $V_{IN} = 5V$, $V_{BATT_REG} = 4.2V$, $I_{IN_LIM} = 1000mA$, $I_{CC} = 896mA$, $I_{SYS} = 0.4A$, $T_A = 25^{\circ}C$, unless otherwise noted.

Charge Curve

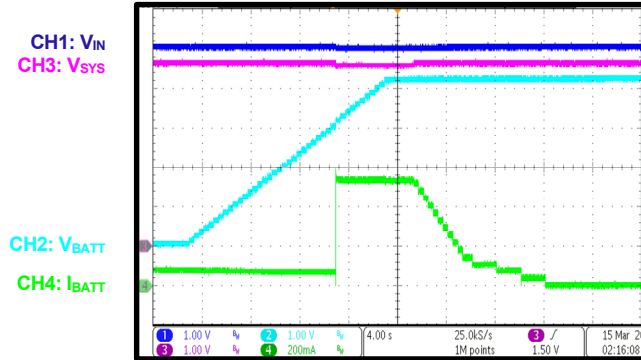

Auto-Recharge

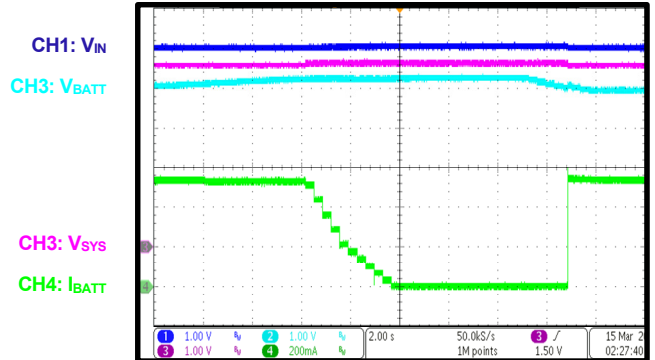

PCB LAYOUT

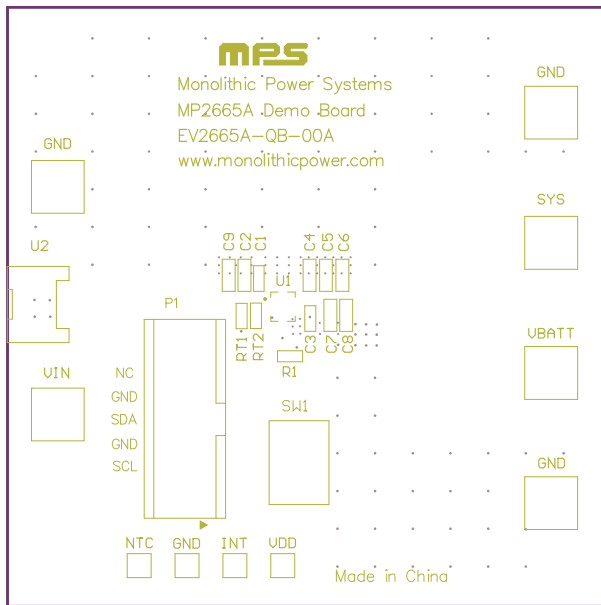

Figure 25: Top Silk

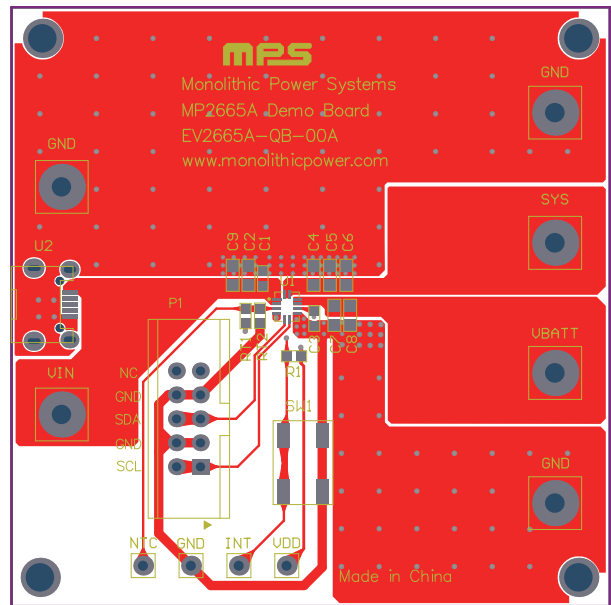

Figure 26: Top Layer

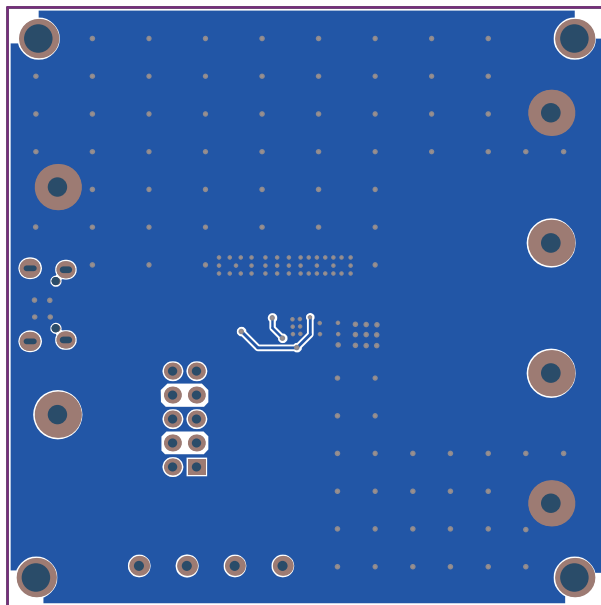

Figure 27: Bottom Layer

REVISION HISTORY

Revision #	Revision Date	Description	Pages Updated
1.0	1/3/2022	Initial Release	-

Notice: The information in this document is subject to change without notice. Please contact MPS for current specifications. Users should warrant and guarantee that third-party Intellectual Property rights are not infringed upon when integrating MPS products into any application. MPS will not assume any legal responsibility for any said applications.