

THIS DOCUMENT IS THE PROPERTY OF KEYSTONE ELECTRONICS CORP. AND SHALL NOT BE REPRODUCED, DISTRIBUTED OR USED AS A BASIS FOR MANUFACTURE WITHOUT PRIOR WRITTEN PERMISSION FROM KEYSTONE ELECTRONICS CORP.

ACTUAL SIZE

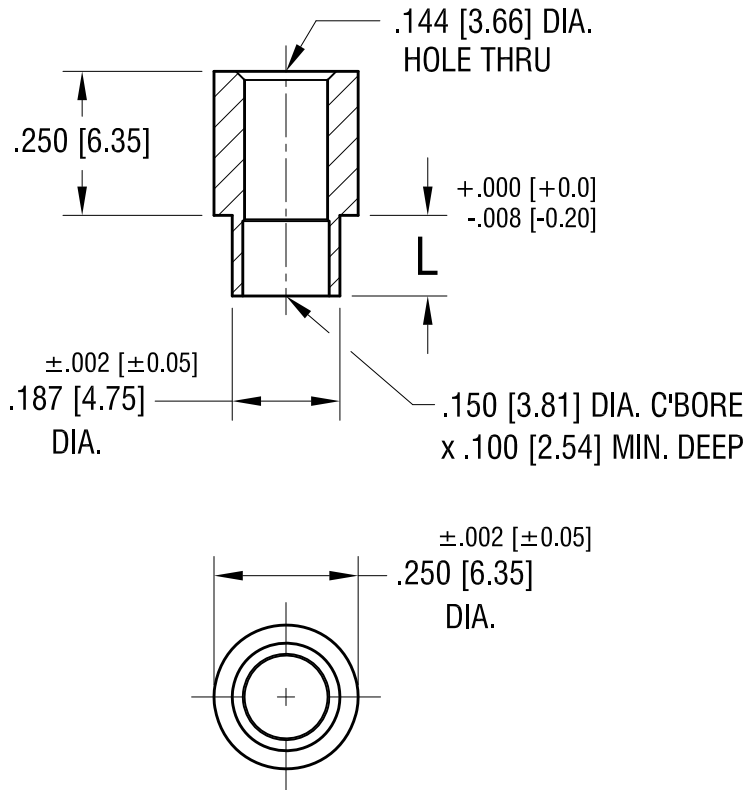

P/N 5063-2



PART NO.	'L' DIM.
5063-2	.109 [2.77]
5063-3	.140 [3.56]

KEYSTONE ELECTRONICS CORP.			
www.keyelco.com • NEW HYDE PARK, NY 11040 • Tel (516) 328-7500			
PART NAME			
ROUND SWAGE CLEAR SPACER			
MATERIAL			
BRASS			
FINISH	DUCTILE NICKEL PLATE	DRN BY	BOONE
		DATE	3.10.00
		APP'D	LN
		SCALE	3X
TOLERANCES	INCH [MM]	CODE	DWG NO.
DECIMAL	± .005 [± 0.13]	C	5063-
ANGULAR	± 1°		
UNLESS OTHERWISE SPECIFIED			

11.19.21	CHANGE AS PER ECN 21-144	A
DATE	DESCRIPTION	REV.