

ANT-GNCP-TH25AL12

L1/L2 Ceramic Patch GNSS Antenna

The ANT-GNCP-TH25AL12 is a global navigation satellite system (GNSS) ceramic patch antenna supporting GPS, Galileo, Beidou, and QZSS systems in the L1/E1/B1 and L2/L2C bands. It provides excellent gain and radiation pattern performance supporting solutions with high location accuracy, rapid satellite signal reception and lock, and quick time to first fix.

The ANT-GNCP-TH25AL12 offers an extended temperature range to +105 °C in support of automotive standard AEC-Q200 Grade 2. The antenna is mounted via attached adhesive patch and has a solder pin signal connection.

FEATURES

- Performance at 1575.42 MHz
 - VSWR: ≤ 1.2
 - Peak Gain: 3.0 dBi
 - Axial ratio: 11.4 dB
- Performance at 1228 MHz
 - VSWR: ≤ 1.4
 - Peak Gain: -2.31 dBi
 - Axial ratio: 21.6 dB
- Directional radiation pattern orthogonal to antenna surface
- Right-hand circularly polarized (RHCP)
- Extended operation to +105 °C
- Adhesive mounting to PCB
- Solder pin signal connection

APPLICATIONS

- Global navigation
 - GPS L1C, L1C/A, L2
 - Galileo E1
 - L1, L2
 - Beidou B1I, B1C
 - QZSS L1, L2C
- Timing solutions
- Automotive location

ORDERING INFORMATION

Part Number	Description
ANT-GNCP-TH25AL12	GNSS L1/L2 band ceramic patch antenna with pin-type solder connection

Available from Linx Technologies and select distributors and representatives.

TABLE 1. ELECTRICAL SPECIFICATIONS

Frequency Band	GPS Bands	VSWR (max.)	Return Loss (dB)	Peak Gain (dBi)	Axial Ratio (dB)
1561 MHz	Beidou B1I	5.0	-3.5	0.9	22.8
1575 MHz	GPS L1C, GPS L1C/A, Galileo E1, Beidou B1C, QZSS L1	5.0	-3.5	3.1	12.6
1601/1602 MHz	L1	2.1	-9.1	4.0	12.8
1228 MHz	GPS L2, QZSS L2	12.1	-1.4	-1.9	23.2
1246/1248 MHz	L2	4.5	-4.0	-0.9	16.2
Impedance	50 Ω				
Polarization	RHCP				
Electrical Type	Radiating Patch				
Wavelength	1/4-wave				
Radiation	Directional radiation pattern orthogonal to antenna surface				
Max Power	8 W				
ESD Sensitivity	ESD sensitive device. As a best practice, Linx uses ESD packaging.				

Electrical specifications and plots measured with a 70 mm x 70 mm (2.76 in x 2.76 in) reference ground plane.

TABLE 2. MECHANICAL SPECIFICATIONS

Parameter	Value
Operating Temp. Range	-40 °C to +105 °C
Connection	Pin Type (Through hole)
Weight	15.8 g (0.60 oz)
Dimensions	25.1 mm x 25.1 mm x 8.0 mm (0.99 in x 0.99 in x 0.31 in)

PRODUCT DIMENSIONS

Figure 1 provides dimensions of the ANT-GNCP-TH25AL12.

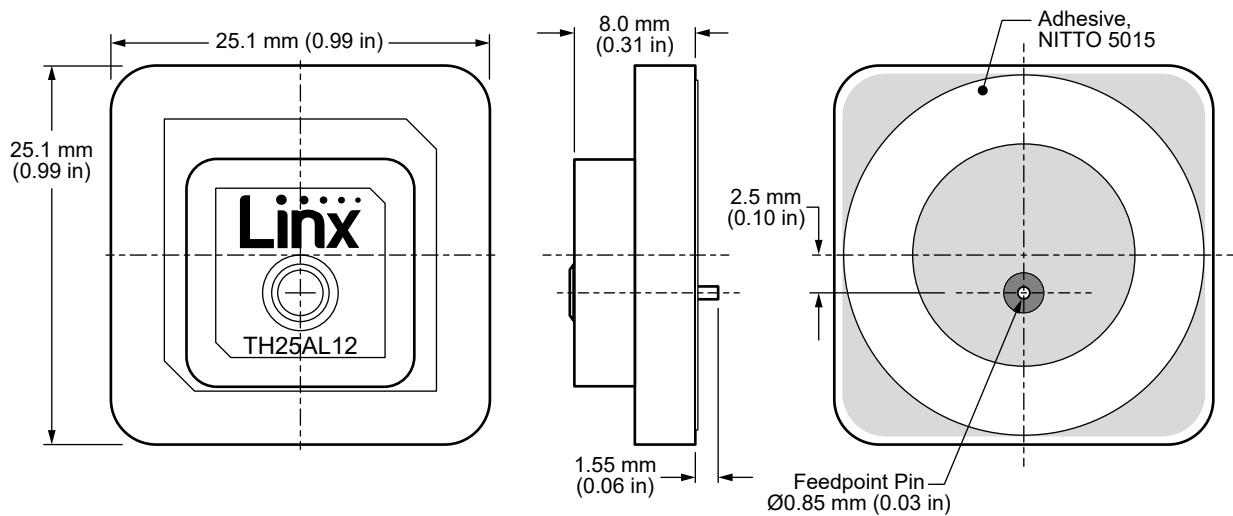

Figure 1. ANT-GNCP-TH25AL12 Antenna Dimensions

VSWR

Figure 2 provides the voltage standing wave ratio (VSWR) across the L1 band, and Figure 3 provides VSWR across the L2 band. VSWR describes the power reflected from the antenna back to the radio. A lower VSWR value indicates better antenna performance at a given frequency. Reflected power is also shown on the right-side vertical axis as a gauge of the percentage of transmitter power reflected back from the antenna.

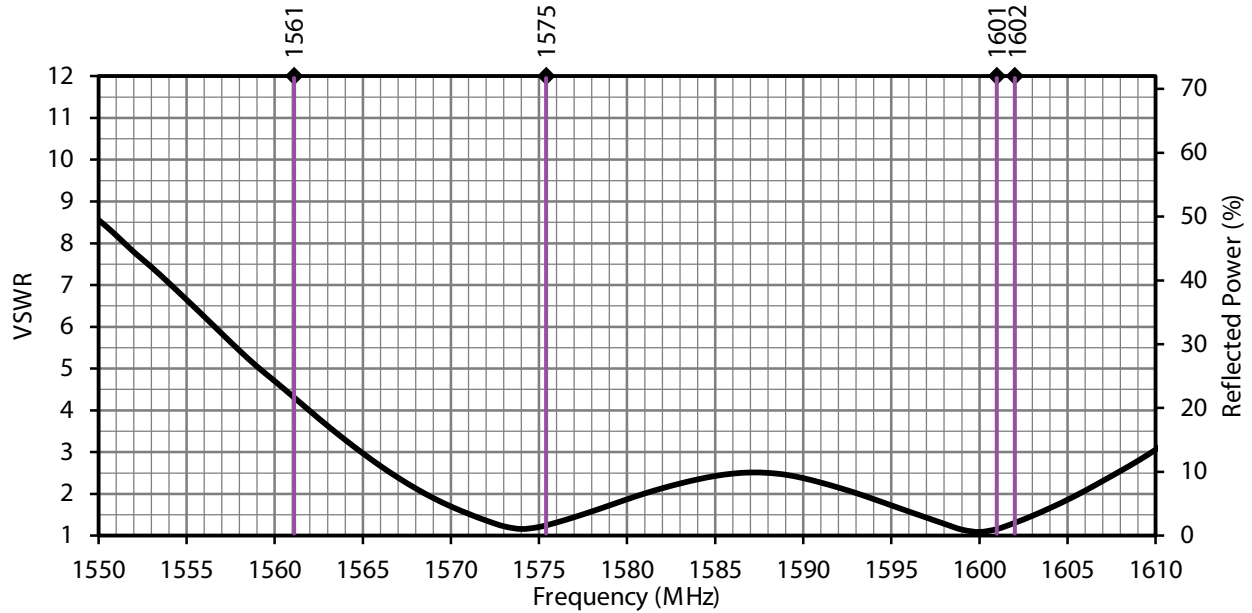

Figure 2. ANT-GNCP-TH25AL12 VSWR, L1 Bands

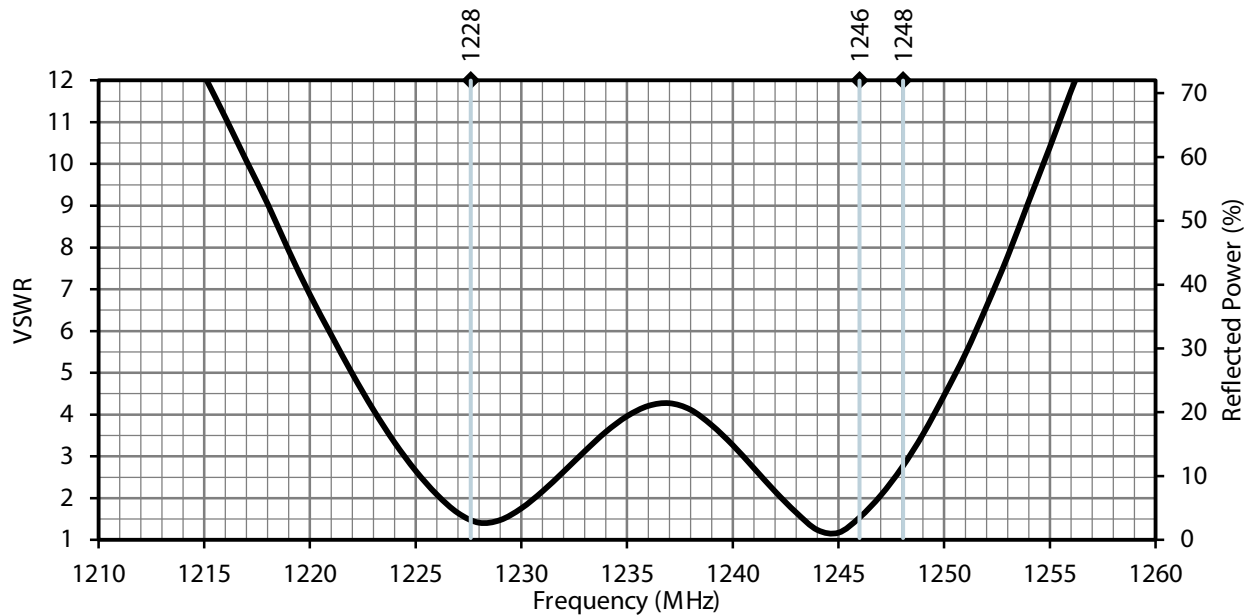

Figure 3. ANT-GNCP-TH25AL12 VSWR, L2 Bands

RETURN LOSS

Return loss, shown in Figure 4 (L1 band) and Figure 5 (L2 band) represents the loss in power at the antenna due to reflected signals. Like VSWR, a lower return loss value indicates better antenna performance at a given frequency.

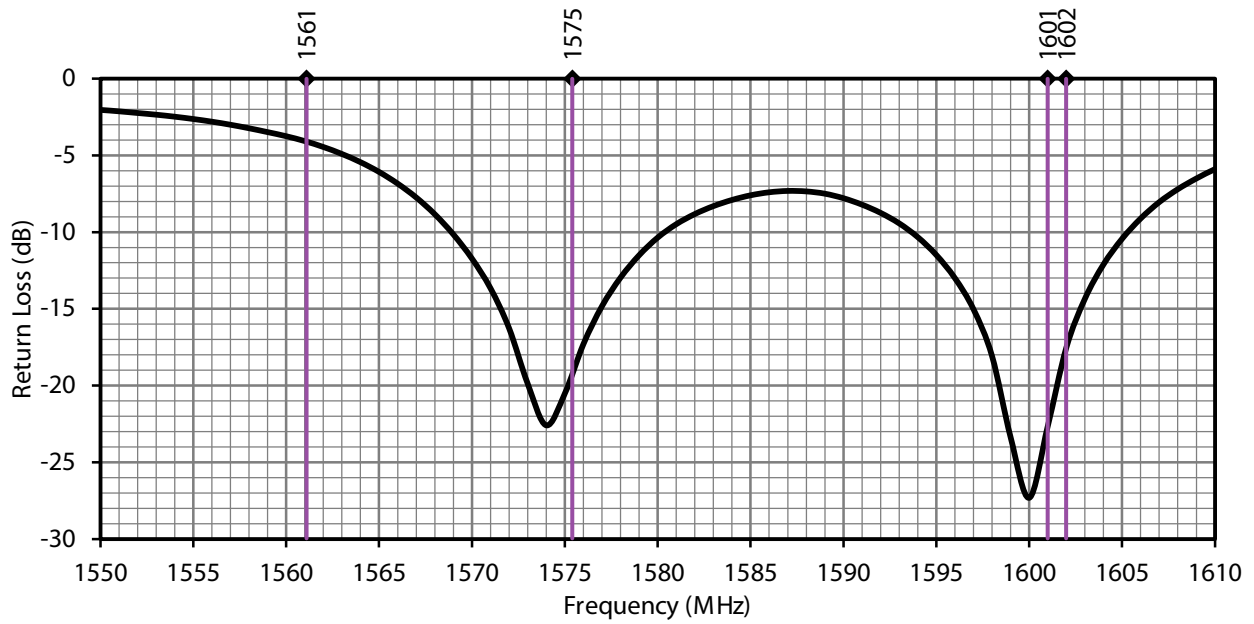

Figure 4. ANT-GNCP-TH25AL12 Return Loss, L1 Bands

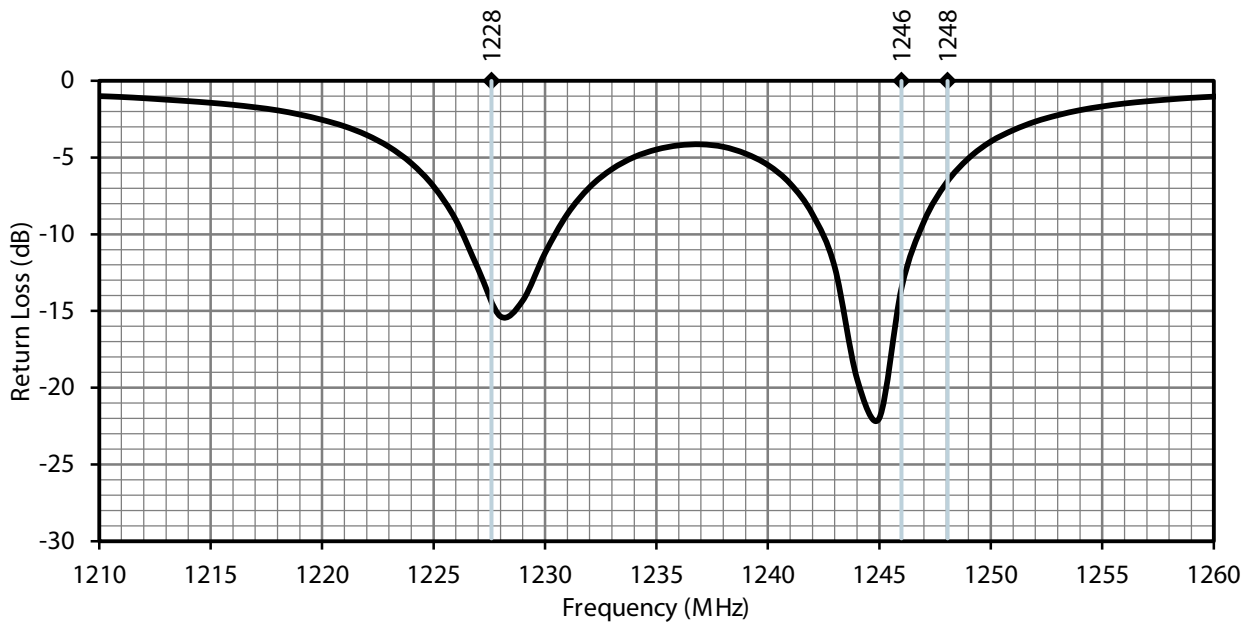

Figure 5. ANT-GNCP-TH25AL12 Return Loss, L2 Bands

PEAK GAIN

The peak gain across the antenna bandwidth is shown in Figure 6 (L1 band) and Figure 7 (L2 band). Peak gain represents the maximum antenna input power concentration across 3-dimensional space, and therefore peak performance at a given frequency, but does not consider any directionality in the gain pattern.

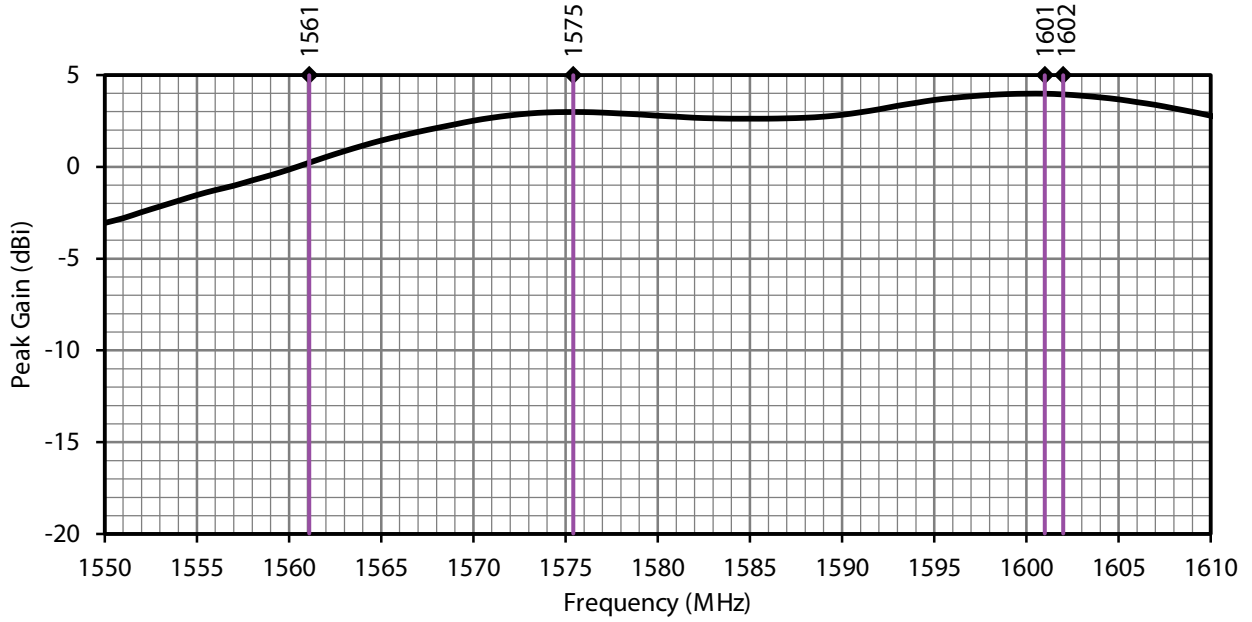

Figure 6. ANT-GNCP-TH25AL12 Peak Gain, L1 Bands

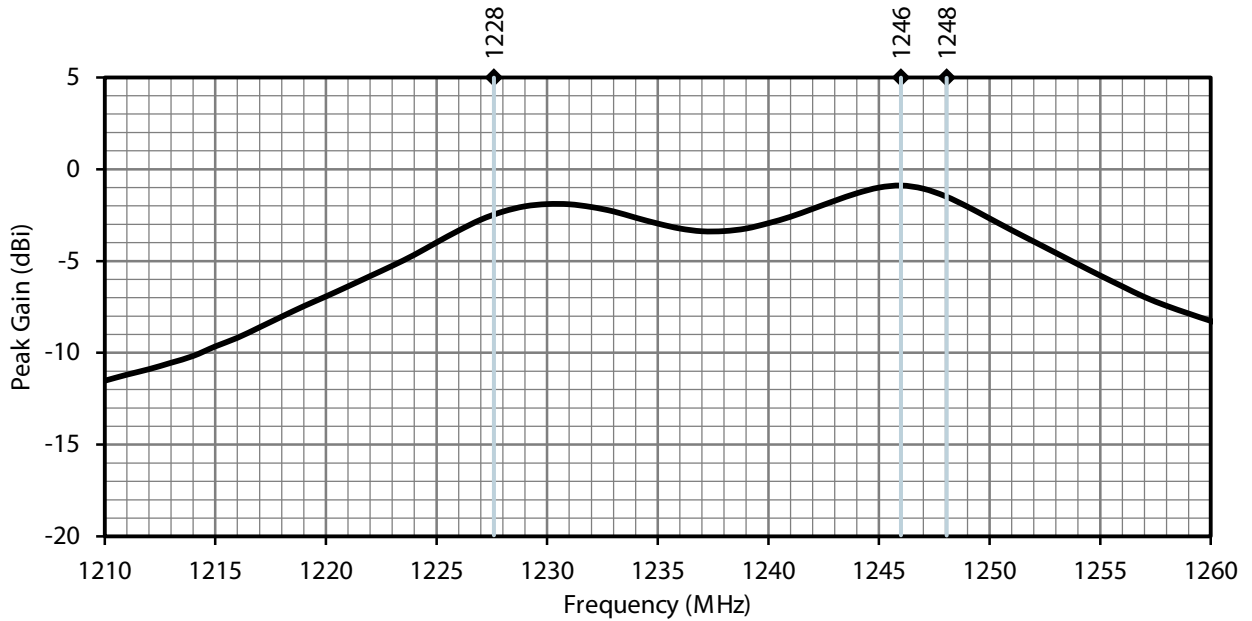

Figure 7. ANT-GNCP-TH25AL12 Peak Gain, L2 Bands

AVERAGE GAIN

Average gain shown in Figure 8 (L1 band) and Figure 9 (L2 band), is the average of all antenna gain in 3-dimensional space at each frequency, providing an indication of overall performance without expressing antenna directionality.

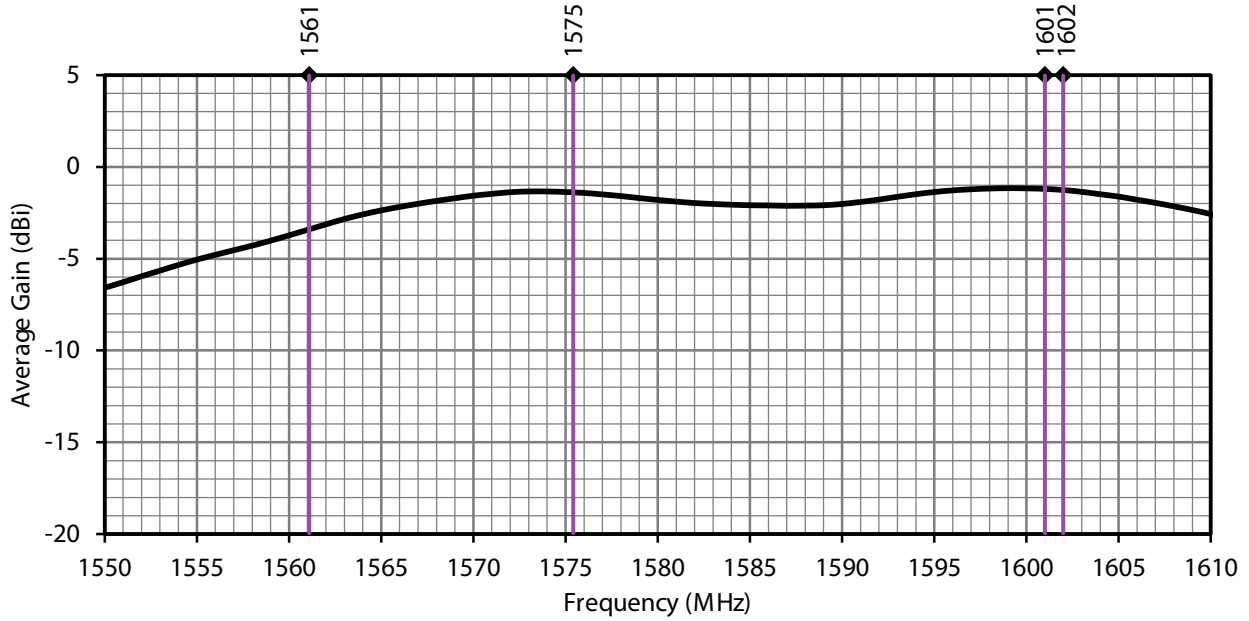

Figure 8. ANT-GNCP-TH25AL12 Antenna Average Gain, L1 Bands

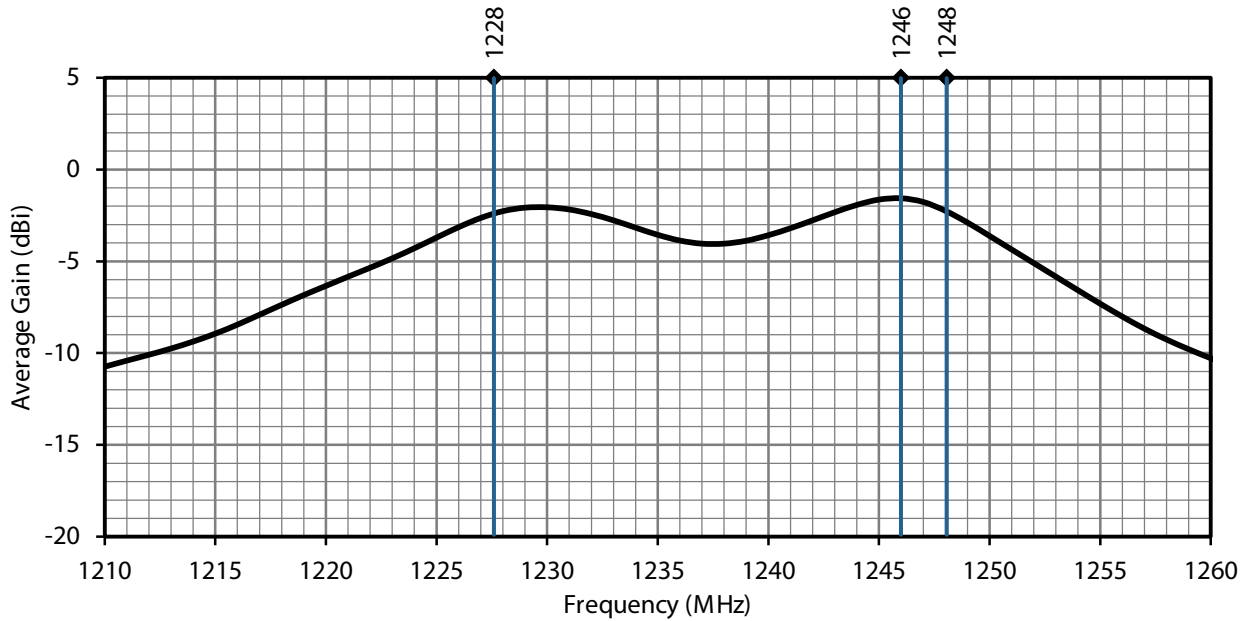

Figure 9. ANT-GNCP-TH25AL12 Antenna Average Gain, L2 Bands

RADIATION EFFICIENCY

Radiation efficiency Figure 10 (L1 band) and Figure 11 (L2 band), shows the ratio of power delivered to the antenna relative to the power radiated at the antenna, expressed as a percentage, where a higher percentage indicates better performance at a given frequency.

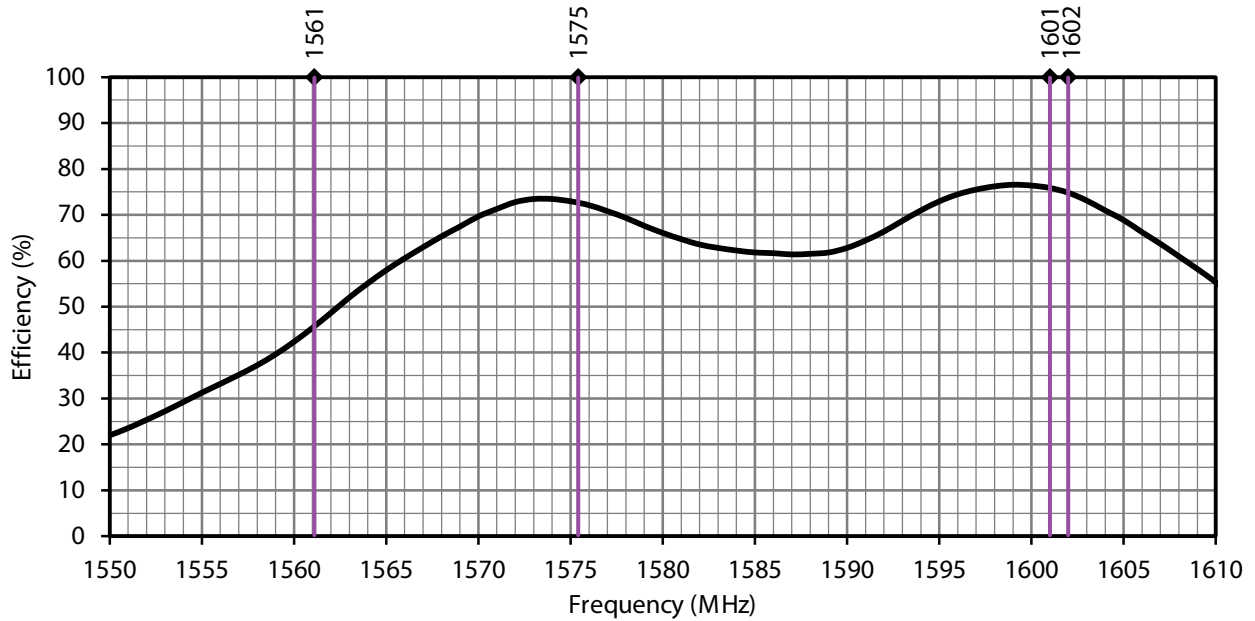

Figure 10. ANT-GNCP-TH25AL12 Antenna Radiation Efficiency, L1 Bands

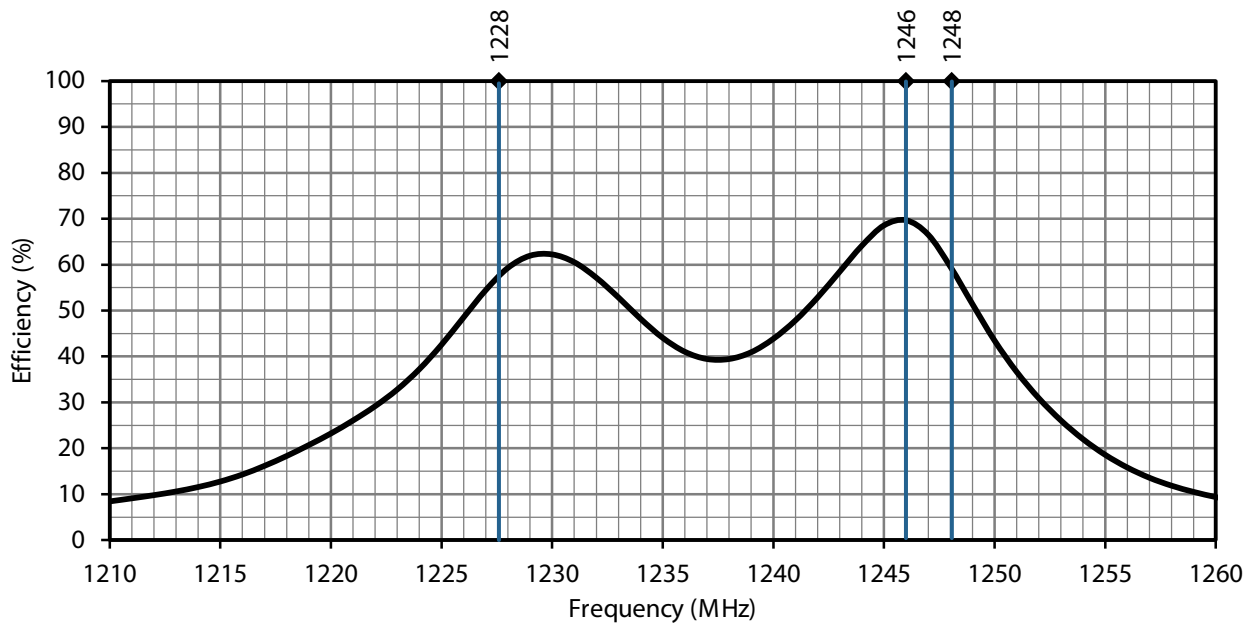

Figure 11. ANT-GNCP-TH25AL12 Antenna Radiation Efficiency, L2 Bands

AXIAL RATIO

Axial ratio provides a measure of the quality of circular polarization of an antenna, the lower the value (in dB), the better the circular polarization. A circularly polarized antenna field comprises two orthogonal E-field components. These fields are ideally of equal amplitude, resulting in an axial ratio equal to unity (0 dB). In practice, no antenna is perfectly circular in polarization, the polarization is elliptical as one field has larger magnitude. As the axial ratio increases the antenna gain degrades away from the main beam orthogonal to the antenna surface. The axial ratio for the ANT-GNCP-TH25AL12 antenna is shown in Figure 12 (L1 band) and Figure 13 (L2 band).

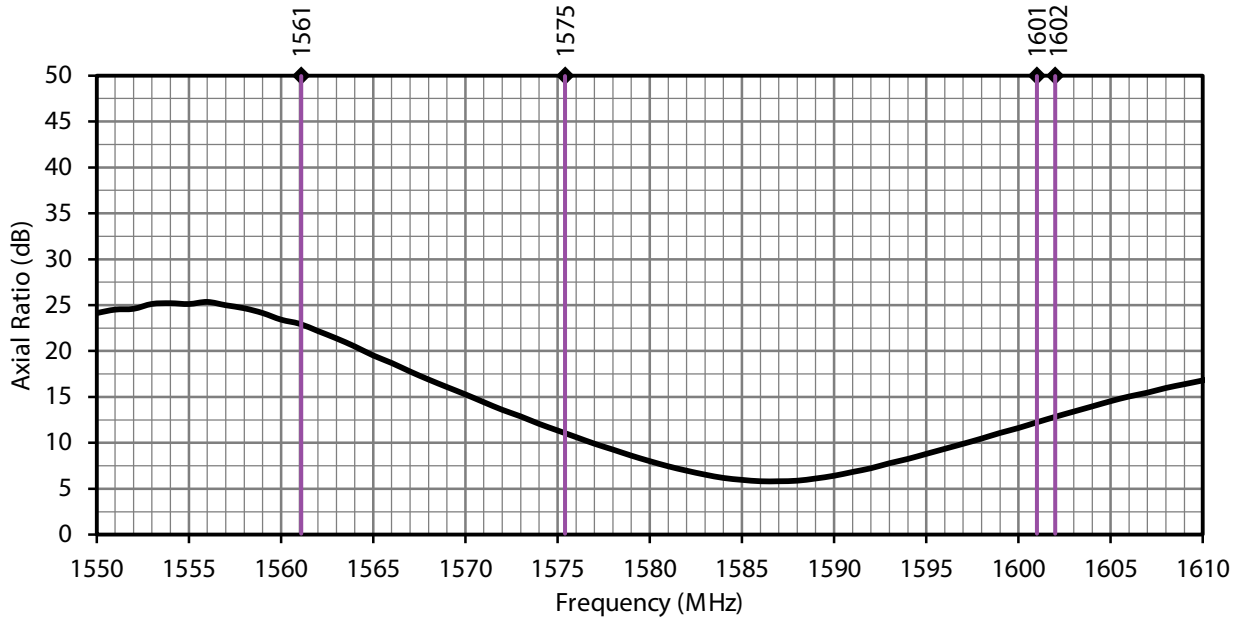

Figure 12. Axial Ratio of the ANT-GNCP-TH25AL12, L1 Bands

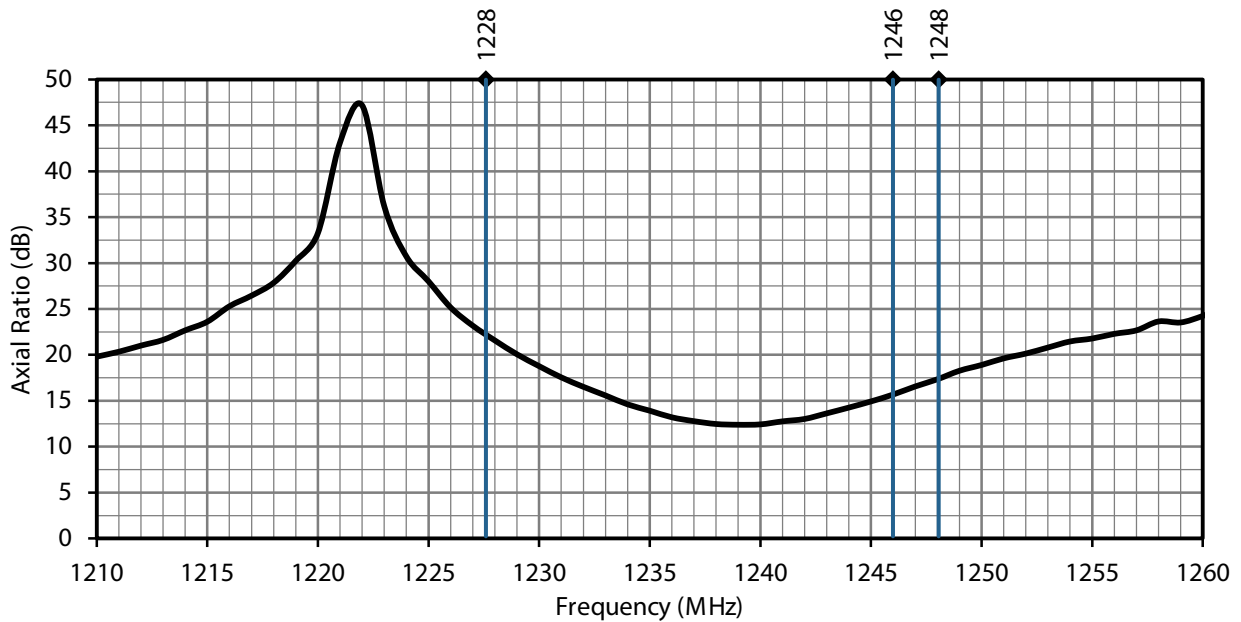
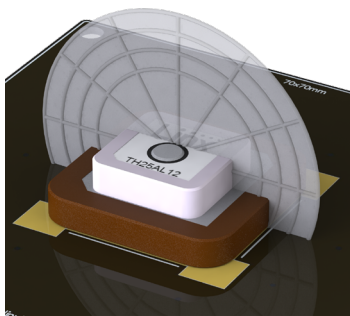

Figure 13. Axial Ratio of the ANT-GNCP-TH25AL12, L2 Bands

RADIATION PATTERNS

Radiation patterns provide information about the directionality and 3-dimensional gain performance of the antenna by plotting gain at specific frequencies in three orthogonal planes. Antenna radiation patterns are shown in Figure 14 using polar plots covering 360 degrees. The antenna graphic at the top of the page provides reference to the plane of the column of plots below it. Note: when viewed with typical PDF viewing software, zooming into radiation patterns is possible to reveal fine detail.



XZ-Plane Gain

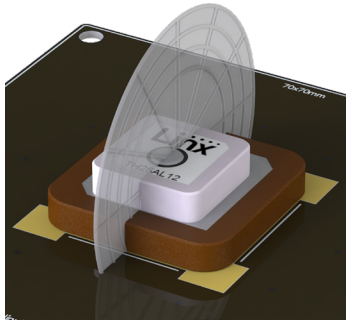

YZ-Plane Gain

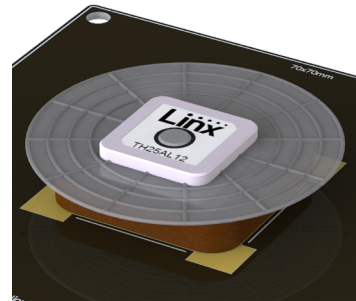

XY-Plane Gain

1215 MHz to 1240 MHz (1228 MHz)

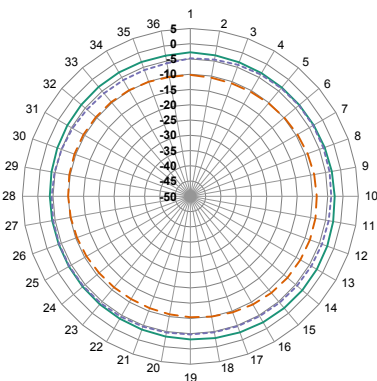

XZ-Plane Gain

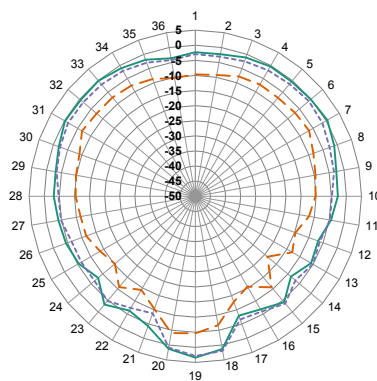

YZ-Plane Gain

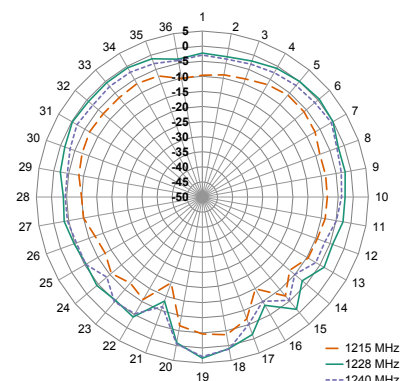

XY-Plane Gain

1243 MHz to 1250 MHz (1248 MHz)

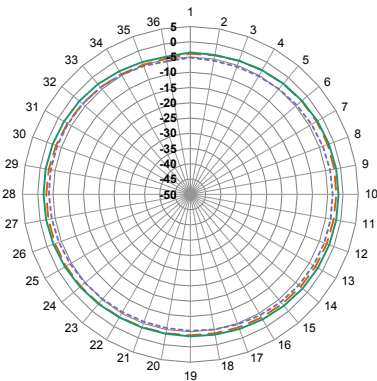

XZ-Plane Gain

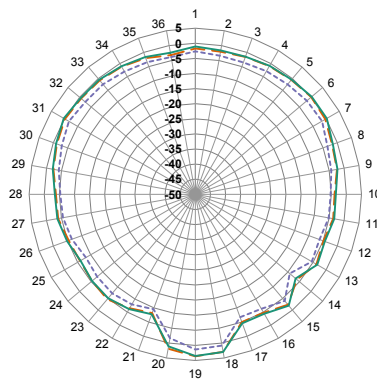

YZ-Plane Gain

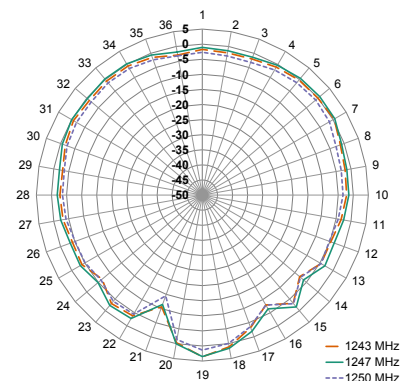

XY-Plane Gain

1559 MHz to 1563 MHz (1561 MHz)

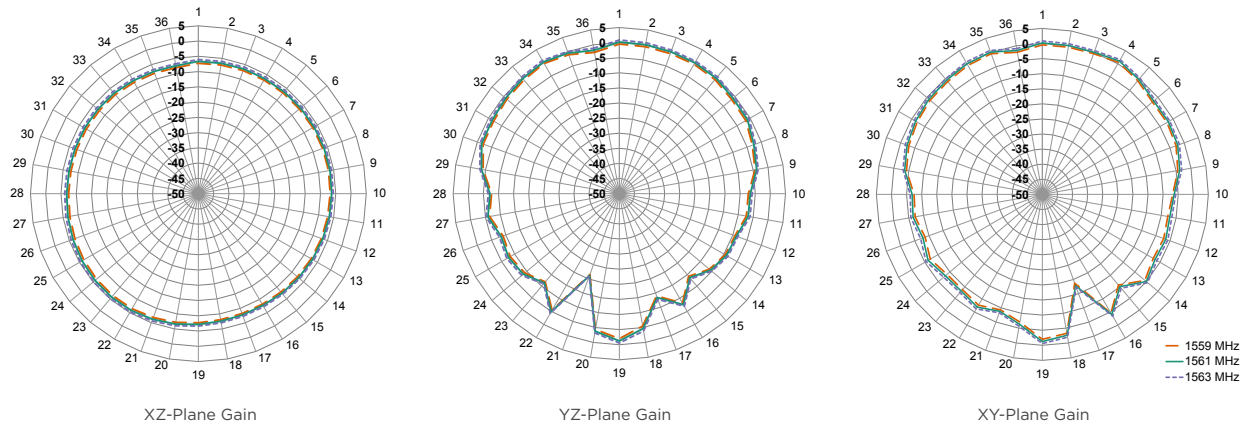

1559 MHz to 1592 MHz (1575 MHz)

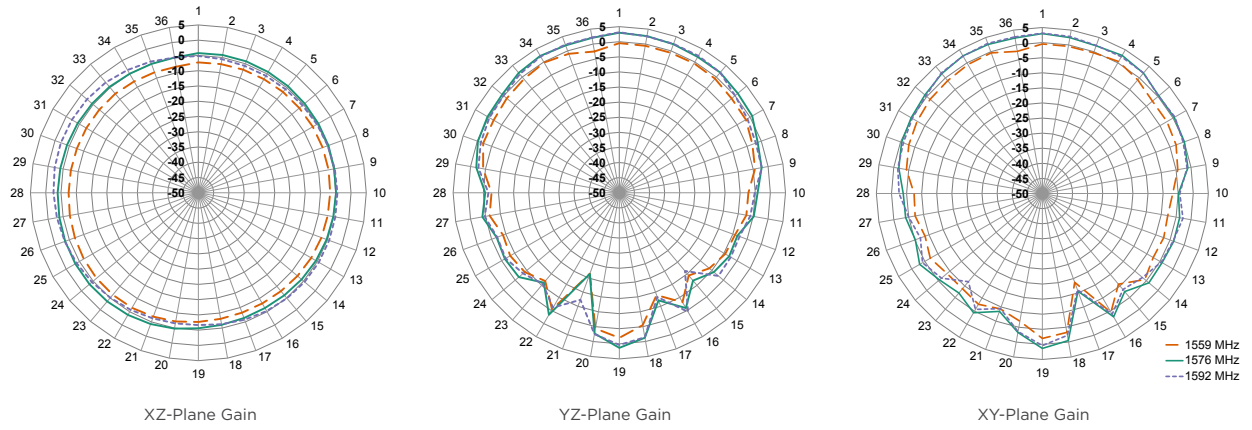

1598 MHz to 1606 MHz (1601 MHz)

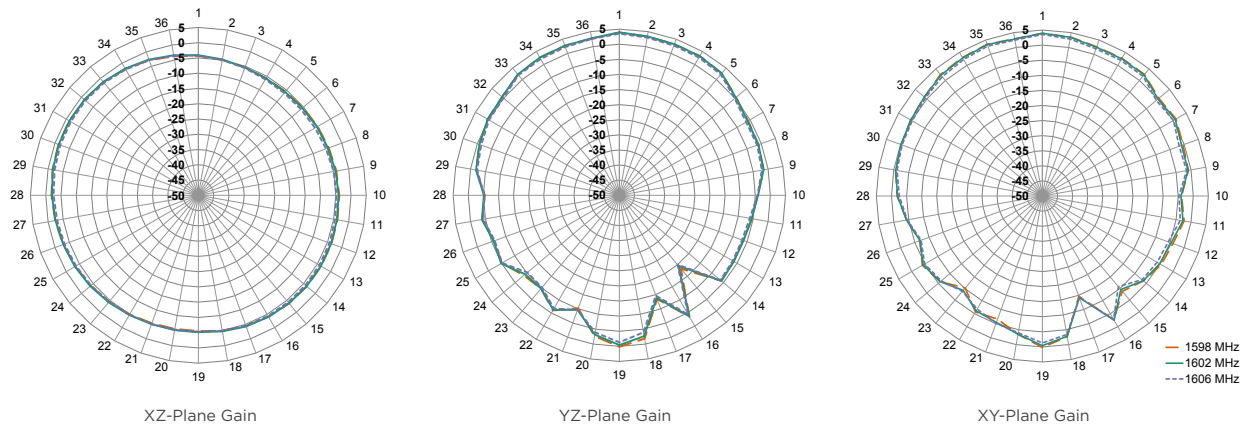

Figure 14. ANT-GNCP-TH25AL12 Radiation Patterns

GROUND PLANE

Ceramic patch antennas are directional in signal transmission and reception orthogonal to the surface plane of the antenna, and require a ground plane for proper operation. The larger the ground plane, the narrower the antenna signal beam, and generally, the better the VSWR performance of the antenna. Relatively smaller ground planes produce wider signal beams. Linx recommends the ground plane size shown in the Electrical Specifications table to achieve performance similar to that shown in this datasheet. Other ground plane sizes and antenna mounting locations are possible. The antenna should be mounted at the center of the ground plane for best performance. Linx offers PCB design reviews to help optimize solution performance.

MOUNTING

The ANT-GNCP-TH25AL12 may be mounted by mechanical means (e.g. bracket, not included) or using an adhesive patch (not included). Alternatively, the antenna may be mounted by soldering the antenna base to a printed circuit board (PCB) - see application note, AN-00504 on the Linx website for more information.

RECOMMENDED LAYOUT

The recommended printed circuit board (PCB) layout for the ANT-GNCP-TH25AL12 is shown in Figure 15. Contact Linx for availability of PCB layout design files.

The recommended layout includes a matching network, ground plane and PCB transmission line from the antenna to the matching network, and to the connector or radio circuitry. The connector used for the printed circuit board is optional, the transmission line may be run directly to the radio if on the same PCB.

Linx recommends inclusion of at least a 3-element, surface mount pi matching network of two parallel capacitors, (X1, X3) and one serial inductor, (X2) in all designs (Figure 16). Surface mount components should be 0603 size. 0402 size components are also supported. The GNCP series antennas, as designed, do not require matching, but matching may improve end-product antenna performance depending on the effects of the enclosure, PCB and other electronic components. If no matching is necessary, the serial element may be populated with a zero-ohm resistor and no components in the two capacitor positions. Linx believes in wireless made simple® and offers matching network design support.

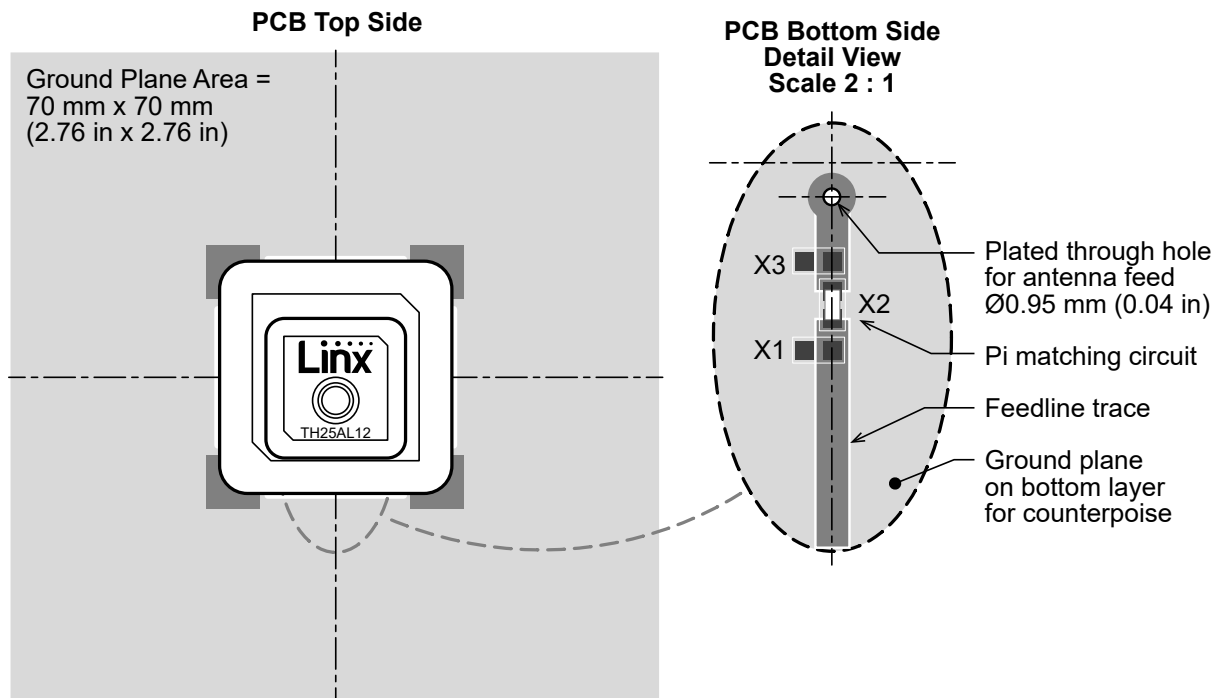

Figure 15. Recommended PCB Layout for the ANT-GNCP-TH25AL12

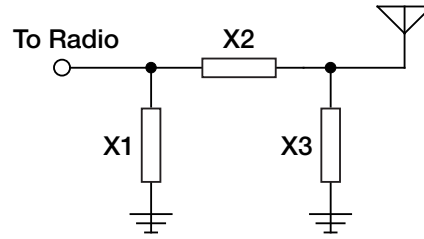

Figure 16. Matching Network Recommendation

RECOMMENDED PCB FOOTPRINT

Figure 17 shows the recommended printed circuit board footprint and spacing for the ANT-GNCP- TH25AL12 antenna. The footprint recommendation should be used in conjunction with the recommended layout configuration shown in Figure 15.

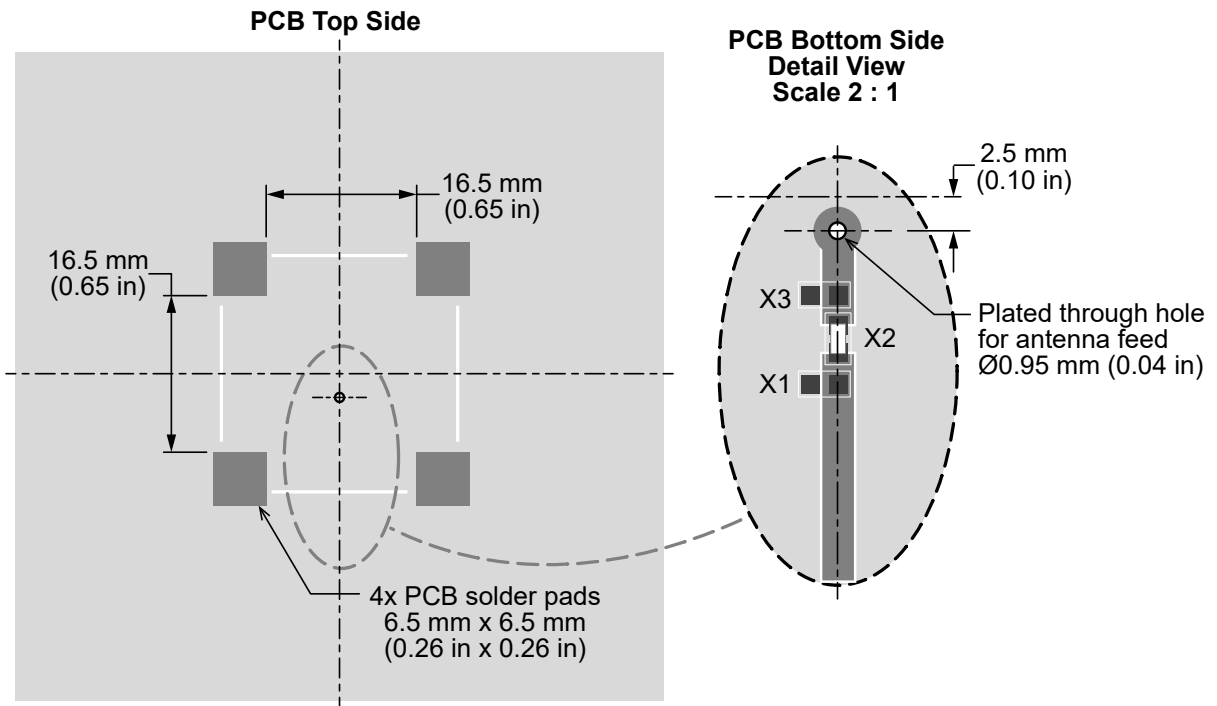

Figure 15. Recommended PCB Layout for the ANT-GNCP-TH25AL12

TRANSMISSION LINES FOR EMBEDDED ANTENNAS

For most designs, Linx recommends a microstrip transmission line for the ANT-GNCP-TH25AL12 antenna. A microstrip transmission line is a PCB trace that runs over a ground plane to maintain the characteristic impedance for optimal signal transfer between the antenna and radio circuitry. Linx designs all antennas with a characteristic impedance of 50 Ω .

Important practices to observe when designing a transmission line are:

- Keep all transmission lines to a minimum length for best signal performance.
- Use RF components that also operate at a 50 Ω impedance.
- If the radio is not on the same PCB as the antenna, the microstrip should be terminated in a connector, enabling a shielded cable to complete the antenna connection to the radio.
- For designs subject to significant electromagnetic interference, a coplanar waveguide transmission line may be used on the PCB.

The design of a PCB transmission line can be aided by many commercially available software packages which can calculate the correct transmission line width and gap dimensions based upon the PCB thickness and dielectric constant used. Linx offers PCB design reviews to help optimize solution performance.

PACKAGING INFORMATION

The ANT-GNCP-TH25AL12 antenna is packaged in a protective plastic tray in quantities of 25. Distribution channels may offer alternative packaging options.

TE TECHNICAL SUPPORT CENTER

USA:	+1 (800) 522-6752
Canada:	+1 (905) 475-6222
Mexico:	+52 (0) 55-1106-0800
Latin/S. America:	+54 (0) 11-4733-2200
Germany:	+49 (0) 6251-133-1999
UK:	+44 (0) 800-267666
France:	+33 (0) 1-3420-8686
Netherlands:	+31 (0) 73-6246-999
China:	+86 (0) 400-820-6015

te.com

TE Connectivity, TE, TE connectivity (logo), Linx and Linx Technologies are trademarks owned or licensed by the TE Connectivity Ltd. family of companies. All other logos, products and/or company names referred to herein might be trademarks of their respective owners.

The information given herein, including drawings, illustrations and schematics which are intended for illustration purposes only, is believed to be reliable. However, TE Connectivity makes no warranties as to its accuracy or completeness and disclaims any liability in connection with its use. TE Connectivity's obligations shall only be as set forth in TE Connectivity's Standard Terms and Conditions of Sale for this product and in no case will TE Connectivity be liable for any incidental, indirect or consequential damages arising out of the sale, resale, use or misuse of the product. Users of TE Connectivity products should make their own evaluation to determine the suitability of each such product for the specific application.

TE Connectivity warrants to the original end user customer of its products that its products are free from defects in material and workmanship. Subject to conditions and limitations TE Connectivity will, at its option, either repair or replace any part of its products that prove defective because of improper workmanship or materials. This limited warranty is in force for the useful lifetime of the original end product into which the TE Connectivity product is installed. Useful lifetime of the original end product may vary but is not warranted to exceed one (1) year from the original date of the end product purchase.

©2022 TE Connectivity. All Rights Reserved.

10/22 Original