

TinyLogic UHS Dual 2-Input NOR Gate

NC7WZ02

Description

The NC7WZ02 is a dual 2-Input NOR Gate from onsemi's Ultra High Speed Series of TinyLogic. The device is fabricated with advanced CMOS technology to achieve ultra high speed with high output drive while maintaining low static power dissipation over a very broad V_{CC} operating range. The device is specified to operate over the 1.65 V to 5.5 V V_{CC} range. The inputs and output are high impedance when V_{CC} is 0 V. Inputs tolerate voltages up to 6.5 V independent of V_{CC} operating voltage.

Features

- Space Saving US8 Surface Mount Package
- MicroPak™ Pb-Free Leadless Package
- Ultra High Speed: $t_{PD} = 2.4$ ns Typ. into 50 pF at 5 V V_{CC}
- High Output Drive: ± 24 mA at 3 V V_{CC}
- Broad V_{CC} Operating Range: 1.65 V to 5.5 V
- Matches the Performance of LCX when Operated at 3.3 V V_{CC}
- Power Down High Impedance Inputs / Output
- Overvoltage Tolerant Inputs Facilitate 5 V to 3 V Translation
- Proprietary Noise / EMI Reduction Circuitry Implemented
- These Devices are Pb-Free, Halogen Free/BFR Free and are RoHS Compliant

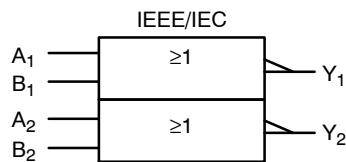
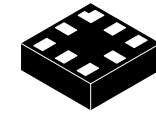
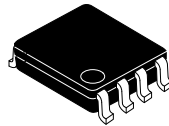

Figure 1. Logic Symbol



UQFN8
1.6X1.6, 0.5P
CASE 523AY

MARKING DIAGRAMS



US8
CASE 846AN

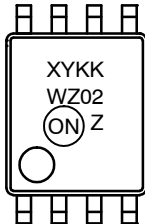

P5, WZ02 = Specific Device Code
KK = 2-Digit Lot Run Traceability Code
XY = 2-Digit Date Code Format
Z = Assembly Plant Code

ORDERING INFORMATION

See detailed ordering, marking and shipping information in the package dimensions section on page 6 of this data sheet.

Connection Diagrams

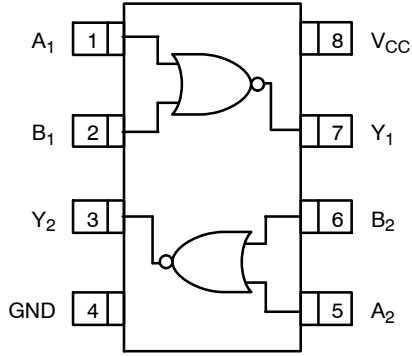

Figure 2. Pin Assignment for US8 (Top View)

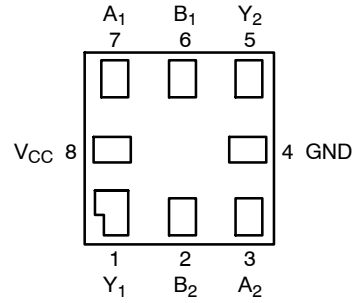
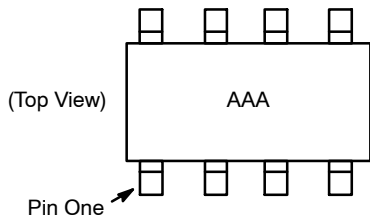

Figure 4. Pad Assignments for MicroPak (Top Through View)



AAA represents Product Code Top Mark – see ordering code
 NOTE: Orientation of Top Mark determines Pin One location.
 Read the top product code mark left to right, Pin One is the lower left pin (see diagram).

Figure 3. US8 Pin One Orientation Diagram

PIN DESCRIPTION

| Pin Names | Description |
|------------|-------------|
| A_n, B_n | Inputs |
| Y_n | Output |

FUNCTION TABLE ($Y = \overline{A + B}$)

| Inputs | | Output |
|--------|---|--------|
| A | B | Y |
| L | L | H |
| L | H | L |
| H | L | L |
| H | H | L |

H = HIGH Logic Level
 L = LOW Logic Level

NC7WZ02

ABSOLUTE MAXIMUM RATINGS

| Symbol | Parameter | | Min | Max | Unit |
|------------------------------------|---|------------------------|------|------|------|
| V _{CC} | Supply Voltage | | -0.5 | 6.5 | V |
| V _{IN} | DC Input Voltage | | -0.5 | 6.5 | V |
| V _{OUT} | DC Output Voltage | | -0.5 | 6.5 | V |
| I _{IK} | DC Input Diode Current | V _{IN} < 0 V | - | -50 | mA |
| I _{OK} | DC Output Diode Current | V _{OUT} < 0 V | - | -50 | mA |
| I _{OUT} | DC Output Current | | - | ±50 | mA |
| I _{CC} / I _{GND} | DC V _{CC} / GND Current | | - | ±100 | mA |
| T _{STG} | Storage Temperature | | -65 | +150 | °C |
| T _J | Junction Temperature under Bias | | - | 150 | °C |
| T _L | Junction Lead Temperature (Soldering, 10 Seconds) | | - | 260 | °C |
| P _D | Power Dissipation in Still Air | US8 | - | 500 | mW |
| | | MicroPak-8 | - | 539 | |

Stresses exceeding those listed in the Maximum Ratings table may damage the device. If any of these limits are exceeded, device functionality should not be assumed, damage may occur and reliability may be affected.

RECOMMENDED OPERATING CONDITIONS

| Symbol | Parameter | | Min | Max | Unit |
|---------------------------------|-------------------------------|---|------|-----------------|------|
| V _{CC} | Supply Voltage Operating | | 1.65 | 5.5 | V |
| | Supply Voltage Data Retention | | 1.5 | 5.5 | |
| V _{IN} | Input Voltage | | 0 | 5.5 | V |
| V _{OUT} | Output Voltage | | 0 | V _{CC} | V |
| T _A | Operating Temperature | | -40 | +85 | °C |
| t _r , t _f | Input Rise and Fall Time | V _{CC} @ 1.8 V ±0.15 V, 2.5 V ±0.2 V | 0 | 20 | ns/V |
| | | V _{CC} @ 3.3 V ±0.3 V | 0 | 10 | |
| | | V _{CC} @ 5.0 V ±0.5 V | 0 | 5 | |
| θ _{JA} | Thermal Resistance | US8 | - | 250 | °C/W |
| | | MicroPak-8 | - | 232 | |

Functional operation above the stresses listed in the Recommended Operating Ranges is not implied. Extended exposure to stresses beyond the Recommended Operating Ranges limits may affect device reliability.

1. Unused inputs must be held HIGH or LOW. They may not float.

NC7WZ02

DC ELECTRICAL CHARACTERISTICS

| Symbol | Parameter | Conditions | V _{CC} (V) | T _A = +25°C | | | T _A = -40 to +85°C | | Unit |
|------------------|---------------------------|---|---------------------|------------------------|------|----------------------|-------------------------------|----------------------|------|
| | | | | Min | Typ | Max | Min | Max | |
| V _{IH} | HIGH Level Input Voltage | | 1.65 to 1.95 | 0.65 V _{CC} | - | - | 0.65 V _{CC} | - | V |
| | | | 2.3 to 5.5 | 0.70 V _{CC} | - | - | 0.70 V _{CC} | - | |
| V _{IL} | LOW Level Input Voltage | | 1.65 to 1.95 | - | - | 0.35 V _{CC} | - | 0.35 V _{CC} | V |
| | | | 2.3 to 5.5 | - | - | 0.30 V _{CC} | - | 0.30 V _{CC} | |
| V _{OH} | HIGH Level Output Voltage | V _{IN} = V _{IH} or V _{IL} , I _{OH} = -100 μA | 1.65 | 1.55 | 1.65 | - | 1.55 | - | V |
| | | | 2.3 | 2.2 | 2.3 | - | 2.2 | - | |
| | | | 3.0 | 2.9 | 3.0 | - | 2.9 | - | |
| | | | 4.5 | 4.4 | 4.5 | - | 4.4 | - | |
| | | I _{OH} = -4 mA | 1.65 | 1.29 | 1.52 | - | 1.29 | - | |
| | | I _{OH} = -8 mA | 2.3 | 1.9 | 2.15 | - | 1.9 | - | |
| | | I _{OH} = -16 mA | 3.0 | 2.4 | 2.80 | - | 2.4 | - | |
| | | I _{OH} = -24 mA | 3.0 | 2.3 | 2.68 | - | 2.3 | - | |
| | | I _{OH} = -32 mA | 4.5 | 3.8 | 4.20 | - | 3.8 | - | |
| V _{OL} | LOW Level Output Voltage | V _{IN} = V _{IH} or V _{IL} , I _{OL} = 100 μA | 1.65 | - | 0.0 | 0.1 | - | 0.1 | V |
| | | | 2.3 | - | 0.0 | 0.1 | - | 0.1 | |
| | | | 3.0 | - | 0.0 | 0.1 | - | 0.1 | |
| | | | 4.5 | - | 0.0 | 0.1 | - | 0.1 | |
| | | I _{OL} = 4 mA | 1.65 | - | 0.08 | 0.24 | - | 0.24 | |
| | | I _{OL} = 8 mA | 2.3 | - | 0.10 | 0.3 | - | 0.3 | |
| | | I _{OL} = 16 mA | 3.0 | - | 0.15 | 0.4 | - | 0.4 | |
| | | I _{OL} = 24 mA | 3.0 | - | 0.22 | 0.55 | - | 0.55 | |
| | | I _{OL} = 32 mA | 4.5 | - | 0.22 | 0.55 | - | 0.55 | |
| I _{IN} | Input Leakage Current | V _{IN} = 5.5 V, GND | 1.65 to 5.5 | - | - | ±0.1 | - | ±1.0 | μA |
| I _{OFF} | Power Off Leakage Current | V _{IN} or V _{OUT} = 5.5 V | 0.0 | - | - | 1 | - | 10 | μA |
| I _{CC} | Quiescent Supply Current | V _{IN} = 5.5 V, GND | 1.65 to 5.5 | - | - | 1 | - | 10 | μA |

AC ELECTRICAL CHARACTERISTICS

| Symbol | Parameter | Conditions | V _{CC} (V) | T _A = +25°C | | | T _A = -40 to +85°C | | Unit |
|-------------------------------------|---|---|---------------------|------------------------|------|-----|-------------------------------|-----|------|
| | | | | Min | Typ | Max | Min | Max | |
| t _{PLH} , t _{PHL} | Propagation Delay (Figure 5, 7) | R _L = 1 MΩ, C _L = 15 pF | 1.8 ±0.15 | - | 5.4 | 9.8 | - | 10 | ns |
| | | | 2.5 ±0.2 | - | 3.3 | 5.4 | - | 5.8 | |
| | | | 3.3 ±0.3 | - | 2.5 | 3.8 | - | 4.1 | |
| | | | 5.0 ±0.5 | - | 2.0 | 3.0 | - | 3.3 | |
| | | R _L = 500 Ω, C _L = 50 pF | 3.3 ±0.3 | - | 3.1 | 4.6 | - | 5.0 | |
| | | | 5.0 ±0.5 | - | 2.4 | 3.7 | - | 4.0 | |
| C _{IN} | Input Capacitance | | 0 | - | 2.5 | - | - | pF | |
| C _{PD} | Power Dissipation Capacitance (Figure 6) | (Note 2) | 3.3 | - | 13.5 | - | - | - | pF |
| | | | 5.0 | - | 17.5 | - | - | - | |

2. C_{PD} is defined as the value of the internal equivalent capacitance which is derived from dynamic operating current consumption (I_{CCD}) at no output loading and operating at 50% duty cycle. (see Figure 6) C_{PD} is related to I_{CCD} dynamic operating current by the expression: C_{PD} = I_{CCD} / (V_{CC}) (F).

AC Loading and Waveforms

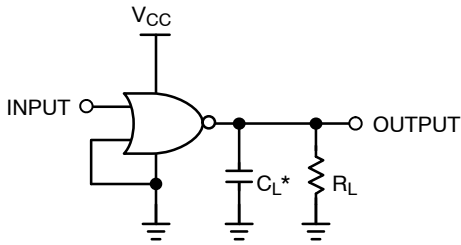

* C_L includes load and stray capacitance
Input PRR = 1.0 MHz, t_W = 500 ns

Figure 5. AC Test Circuit

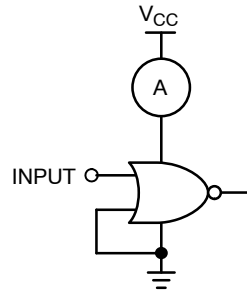

Input = AC Waveform; t_r = t_f = 1.8 ns;
PRR = 10 MHz; Duty Cycle = 50%.

Figure 6. I_{CCD} Test Circuit

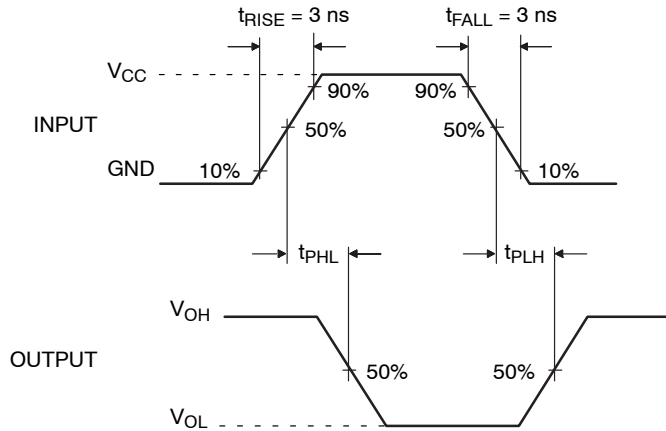

Figure 7. AC Waveforms

NC7WZ02

ORDERING INFORMATION

| Order Number | Top Mark | Package | Shipping† |
|-------------------|----------|---|--------------------|
| NC7WZ02K8X | WZ02 | 8-Lead US8, JEDEC MO-187, Variation CA 3.1 mm Wide | 3000 / Tape & Reel |
| NC7WZ02L8X | P5 | 8-Lead MicroPak, 1.6 mm Wide | 5000 / Tape & Reel |
| NC7WZ02L8X-L22185 | P5 | 8-Lead MicroPak, 1.6 mm Wide | 5000 / Tape & Reel |

†For information on tape and reel specifications, including part orientation and tape sizes, please refer to our Tape and Reel Packaging Specifications Brochure, BRD8011/D.

3. Pb-Free package per JEDEC J-STD-020B.

MicroPak is trademark of Semiconductor Components Industries, LLC (SCILLC) or its subsidiaries in the United States and/or other countries.



UQFN8 1.6X1.6, 0.5P
CASE 523AY
ISSUE O

DATE 31 AUG 2016



**RECOMMENDED
LAND PATTERN**

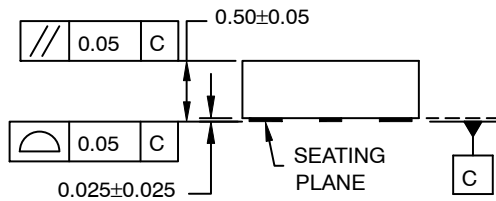

SIDE VIEW

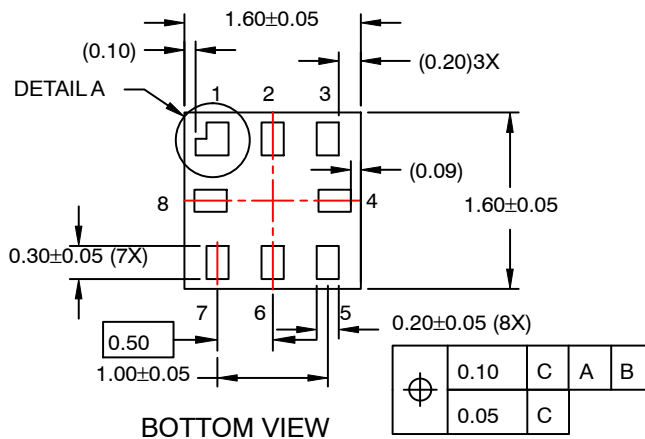

BOTTOM VIEW

NOTES:

- A. PACKAGE CONFORMS TO JEDEC MO-255 VARIATION UAAD.
- B. DIMENSIONS ARE IN MILLIMETERS.
- C. DIMENSIONS AND TOLERANCES PER ASME Y14.5M, 2009.
- D. LAND PATTERN RECOMMENDATION IS EXISTING INDUSTRY LAND PATTERN.

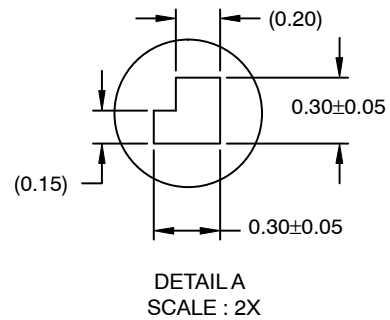

**DETAIL A
SCALE : 2X**

| | | |
|-------------------------|----------------------------|--|
| DOCUMENT NUMBER: | 98AON13591G | Electronic versions are uncontrolled except when accessed directly from the Document Repository. Printed versions are uncontrolled except when stamped "CONTROLLED COPY" in red. |
| DESCRIPTION: | UQFN8 1.6X1.6, 0.5P | PAGE 1 OF 1 |

ON Semiconductor and are trademarks of Semiconductor Components Industries, LLC dba ON Semiconductor or its subsidiaries in the United States and/or other countries. ON Semiconductor reserves the right to make changes without further notice to any products herein. ON Semiconductor makes no warranty, representation or guarantee regarding the suitability of its products for any particular purpose, nor does ON Semiconductor assume any liability arising out of the application or use of any product or circuit, and specifically disclaims any and all liability, including without limitation special, consequential or incidental damages. ON Semiconductor does not convey any license under its patent rights nor the rights of others.



US8
CASE 846AN
ISSUE O

DATE 31 DEC 2016



NOTES:

- A. CONFORMS TO JEDEC REGISTRATION MO-187
- B. DIMENSIONS ARE IN MILLIMETERS.
- C. DIMENSIONS ARE EXCLUSIVE OF BURRS, MOLD FLASH, AND TIE BAR EXTRUSIONS.
- D. DIMENSIONS AND TOLERANCES PER ANSI Y14.5M, 1994.



| | | |
|-------------------------|-------------|--|
| DOCUMENT NUMBER: | 98AON13778G | Electronic versions are uncontrolled except when accessed directly from the Document Repository. Printed versions are uncontrolled except when stamped "CONTROLLED COPY" in red. |
| DESCRIPTION: | US8 | PAGE 1 OF 1 |

ON Semiconductor and are trademarks of Semiconductor Components Industries, LLC dba ON Semiconductor or its subsidiaries in the United States and/or other countries. ON Semiconductor reserves the right to make changes without further notice to any products herein. ON Semiconductor makes no warranty, representation or guarantee regarding the suitability of its products for any particular purpose, nor does ON Semiconductor assume any liability arising out of the application or use of any product or circuit, and specifically disclaims any and all liability, including without limitation special, consequential or incidental damages. ON Semiconductor does not convey any license under its patent rights nor the rights of others.

onsemi, **Onsemi**, and other names, marks, and brands are registered and/or common law trademarks of Semiconductor Components Industries, LLC dba "**onsemi**" or its affiliates and/or subsidiaries in the United States and/or other countries. **onsemi** owns the rights to a number of patents, trademarks, copyrights, trade secrets, and other intellectual property. A listing of **onsemi**'s product/patent coverage may be accessed at www.onsemi.com/site/pdf/Patent-Marking.pdf. **onsemi** reserves the right to make changes at any time to any products or information herein, without notice. The information herein is provided "as-is" and **onsemi** makes no warranty, representation or guarantee regarding the accuracy of the information, product features, availability, functionality, or suitability of its products for any particular purpose, nor does **onsemi** assume any liability arising out of the application or use of any product or circuit, and specifically disclaims any and all liability, including without limitation special, consequential or incidental damages. Buyer is responsible for its products and applications using **onsemi** products, including compliance with all laws, regulations and safety requirements or standards, regardless of any support or applications information provided by **onsemi**. "Typical" parameters which may be provided in **onsemi** data sheets and/or specifications can and do vary in different applications and actual performance may vary over time. All operating parameters, including "Typicals" must be validated for each customer application by customer's technical experts. **onsemi** does not convey any license under any of its intellectual property rights nor the rights of others. **onsemi** products are not designed, intended, or authorized for use as a critical component in life support systems or any FDA Class 3 medical devices or medical devices with a same or similar classification in a foreign jurisdiction or any devices intended for implantation in the human body. Should Buyer purchase or use **onsemi** products for any such unintended or unauthorized application, Buyer shall indemnify and hold **onsemi** and its officers, employees, subsidiaries, affiliates, and distributors harmless against all claims, costs, damages, and expenses, and reasonable attorney fees arising out of, directly or indirectly, any claim of personal injury or death associated with such unintended or unauthorized use, even if such claim alleges that **onsemi** was negligent regarding the design or manufacture of the part. **onsemi** is an Equal Opportunity/Affirmative Action Employer. This literature is subject to all applicable copyright laws and is not for resale in any manner.

PUBLICATION ORDERING INFORMATION

LITERATURE FULFILLMENT:

Email Requests to: orderlit@onsemi.com

onsemi Website: www.onsemi.com

TECHNICAL SUPPORT

North American Technical Support:

Voice Mail: 1 800-282-9855 Toll Free USA/Canada

Phone: 011 421 33 790 2910

Europe, Middle East and Africa Technical Support:

Phone: 00421 33 790 2910

For additional information, please contact your local Sales Representative