

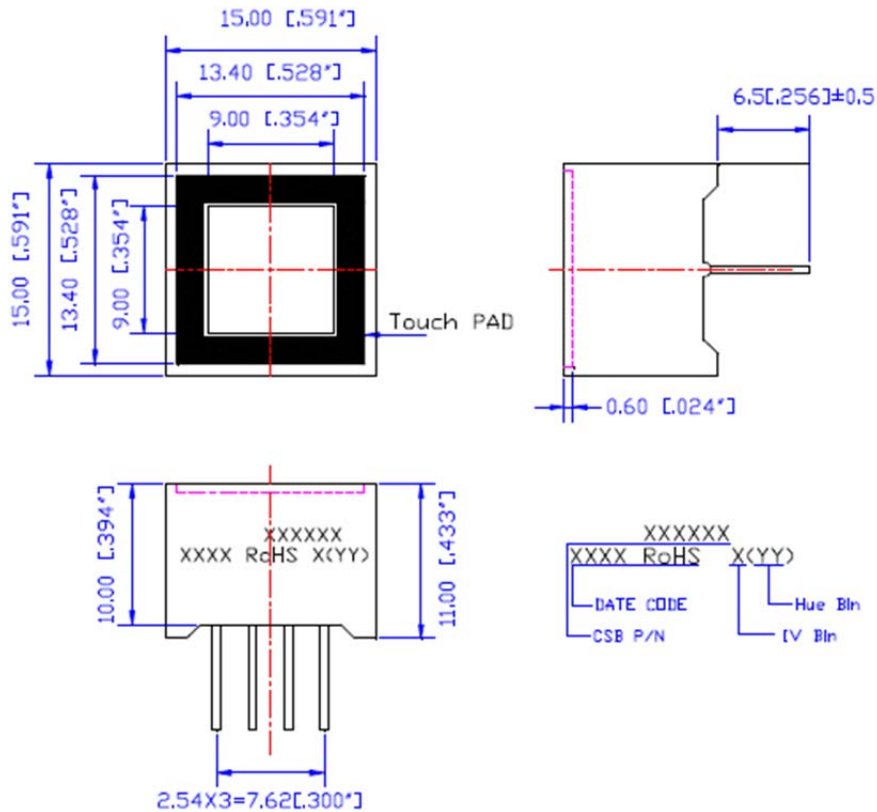

**American Opto Plus LED Corp.**  
**CTD-IC591A-W/W**  
 15.0 x 15.0 x 11.0 mm Amber Touch LED Display w/  
 Touch Drive IC

- ◆ Low Power Consumption
- ◆ RoHS compliant
- ◆ Case mold type
- ◆ Easy Mounting on PC board / socket

## MECHANICAL DIMENSIONS



**Notes:**

1. All pins are 0.60[.024]±0.1[.004]
2. Dimension in millimeter [inch], tolerance is ±0.25 [.010] and angle is ±1° unless otherwise noted.

Part Number	Color	
	Material	Color
CTD-IC591A-W/W	AlGaInP	Amber



**American Opto Plus LED Corp.**  
**CTD-IC591A-W/W**  
15.0 x 15.0 x 11.0 mm Amber Touch LED Display w/  
Touch Drive IC

- ◆ Low Power Consumption
- ◆ RoHS compliant
- ◆ Case mold type
- ◆ Easy Mounting on PC board / socket

## ALL LIGHT ON SEGMENTS FEATURE & PIN POSITION

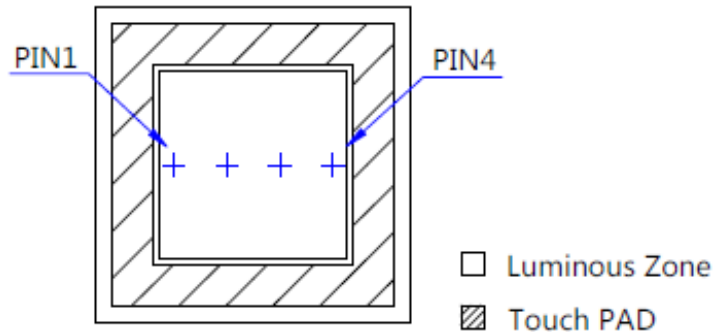

## INTERNAL CIRCUIT DIAGRAMS

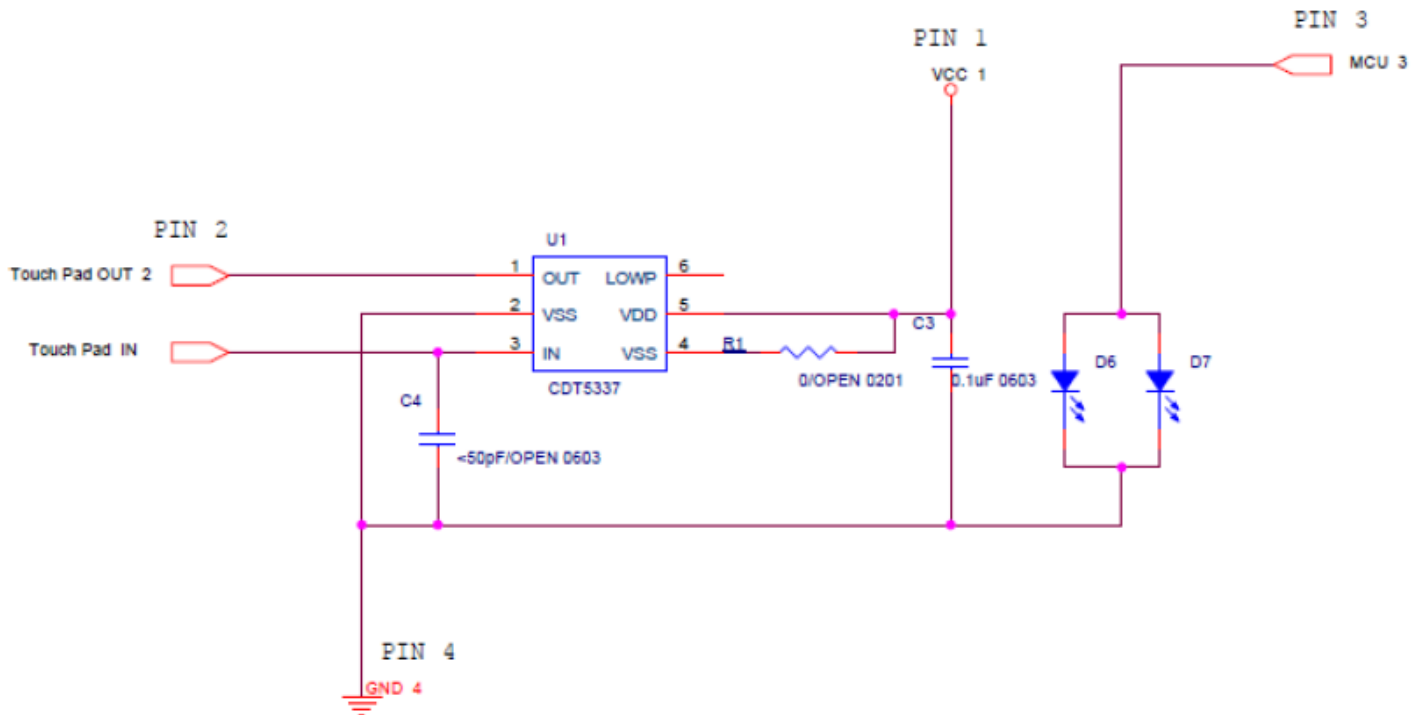



**American Opto Plus LED Corp.**  
**CTD-IC591A-W/W**  
**15.0 x 15.0 x 11.0 mm Amber Touch LED Display w/  
 Touch Drive IC**

- ◆ Low Power Consumption
- ◆ RoHS compliant
- ◆ Case mold type
- ◆ Easy Mounting on PC board / socket

**ABSOLUTE MAXIMUM RATING**

**(Ta=25°C)**

Parameter	Symbol	Rating	Unit
		Amber	
Power Dissipation Per Dice	PAD	70	mW
Derating Liner from 25°C per Dice	-	0.33	mA/°C
Continuous Forward Current Per Dice	IAF	25	mA
Peak Current Per Dice (duty cycle 1/10,1KHz)	IPF	90	mA
Reverse Voltage Per Dice	VR	5	V
Operating Temp.	Topr	-35 ~ +85	°C
Storage Temp.	Tstg	-35 ~ +85	°C

**ELECTRO-OPTICAL CHARACTERISTICS**

**(Ta=25°C)**

Parameter	Symbol	Min.	Typ.	Max.	Unit	Condition
Luminous Intensity	Iv	44	91	--	mcd	IF = 20 mA
Forward Voltage	VF	--	2.0	2.8	V	IF = 20 mA
Peak Emission Wavelength	λP	--	612	--	nm	IF = 20 mA
Dominant Wavelength	λD	--	605	--	nm	IF = 20 mA
Spectrum Radiation Bandwidth	Δλ	--	20	--	nm	IF = 20 mA
Luminous Intensity Matching Ratio	Iv-M	--	-	2 : 1	--	IF = 10 mA
Reverse Current	IR		-	100	μA	VR = 5V



**American Opto Plus LED Corp.**  
**CTD-IC591A-W/W**  
**15.0 x 15.0 x 11.0 mm Amber Touch LED Display w/  
 Touch Drive IC**

- ◆ Low Power Consumption
- ◆ RoHS compliant
- ◆ Case mold type
- ◆ Easy Mounting on PC board / socket

**LUMINOUS GENERAL Iv BIN GRADE (I<sub>r</sub> = 20mA)**

A	B	C	D	E	F	G	H	J	K	L	M
0.155	0.249	0.399	0.640	1.025	1.641	2.627	4.204	6.727	10.764	17.224	27.559
}	}	}	}	}	}	}	}	}	}	}	}
0.248	0.398	0.639	1.024	1.640	2.626	4.203	6.726	10.763	17.223	27.558	44.095
N	P	Q	R	S	T	U	V	W	X	Y	1
44.096	70.555	112.889	180.622	288.997	462.397	739.836	1183.738	1893.982	3030.372	4848.597	7757.756
}	}	}	}	}	}	}	}	}	}	}	}
70.554	112.888	180.622	288.996	462.396	739.835	1183.737	1893.981	3030.371	4848.596	7757.755	12412.409
2	3	4	5	6	7	8	9				
4034.034	19859.858	31775.773	50841.238	81345.982	130153.573	208245.718	333193.149				
}	}	}	}	}	}	}	}				
19859.857	31775.772	50841.237	81345.981	130153.572	208245.717	333193.148	533109.039				

1. Unit = mcd
2. Tolerance: ±20%



**American Opto Plus LED Corp.**  
**CTD-IC591A-W/W**  
15.0 x 15.0 x 11.0 mm Amber Touch LED Display w/  
Touch Drive IC

- ◆ Low Power Consumption
- ◆ RoHS compliant
- ◆ Case mold type
- ◆ Easy Mounting on PC board / socket

**ELECTRICAL/OPTICAL CHARACTERISTICS CURVES (Ta=25°C)**

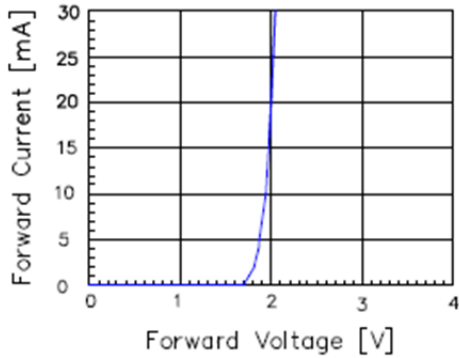

Fig 1. Forward Current vs. Forward Voltage

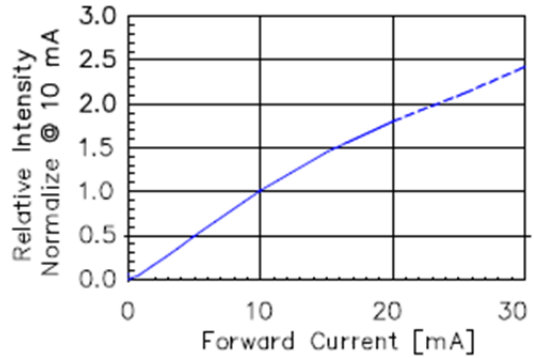

Fig 2. Relative Intensity vs. Forward Current

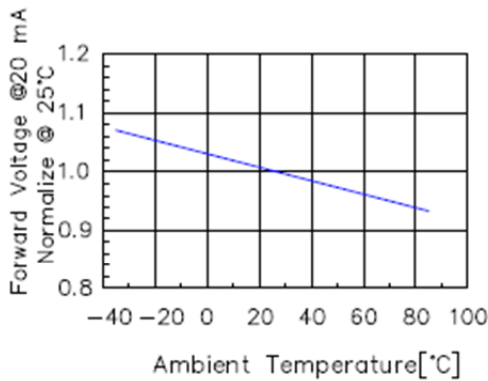

Fig 3. Forward Voltage vs. Temperature

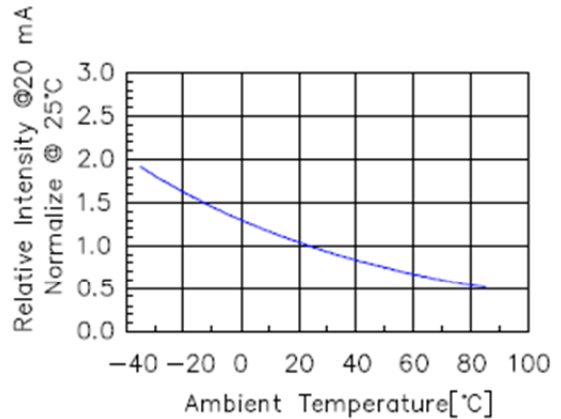

Fig 4. Relative Intensity vs. Temperature

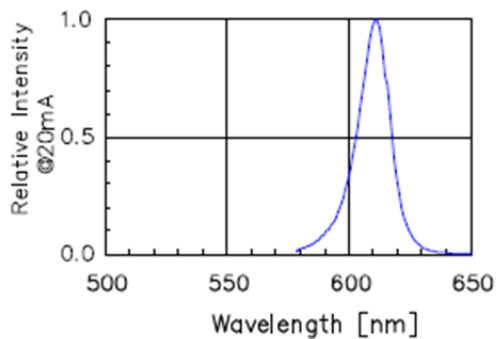

Fig 5. Relative Intensity vs. Wavelength

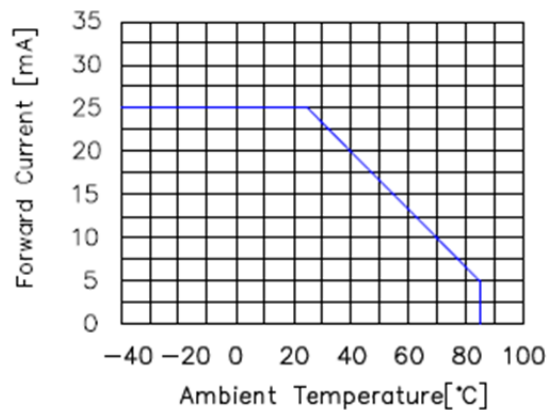

Fig 6. Forward current vs. Temperature



**American Opto Plus LED Corp.**  
**CTD-IC591A-W/W**  
15.0 x 15.0 x 11.0 mm Amber Touch LED Display w/  
Touch Drive IC

- ◆ Low Power Consumption
- ◆ RoHS compliant
- ◆ Case mold type
- ◆ Easy Mounting on PC board / socket

## SOLDERING CONDITIONS

### 1. Wave Soldering Profile

Distance: 1.6mm min (From Seating Plane)

Item	Condition		Note
Preheat	Temperature T1	80 – 120 °C	PWB Temperature (Soldering Side Surface)
	Time t1	60 – 180sec	
Solder Dip	Temperature T2	230 – 260°C	Bath Temperature
	Time t2	2 – 4 sec	Solder Tank Passage Time

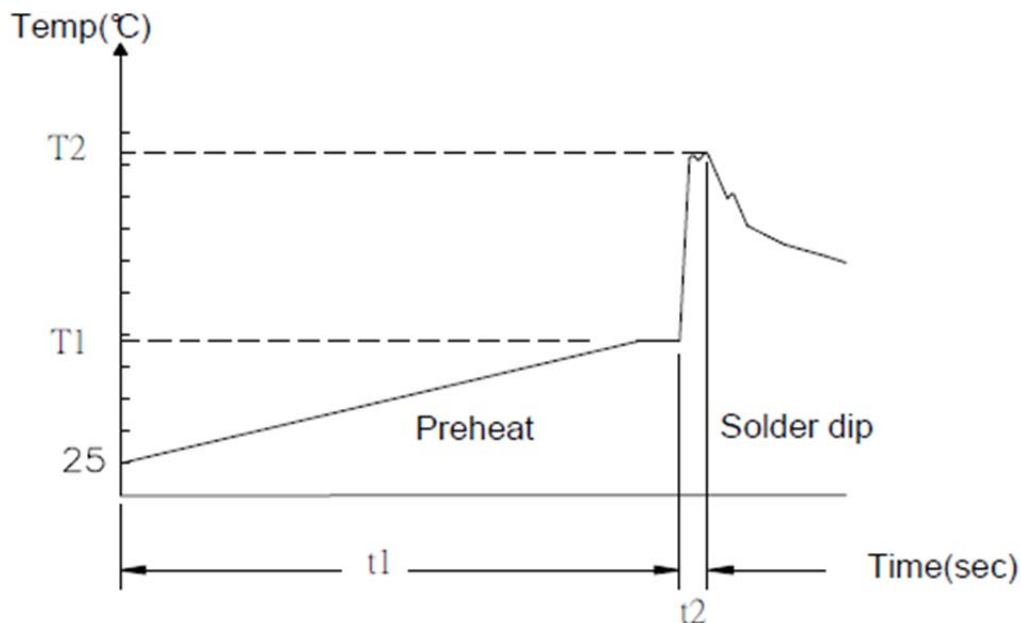

### 2. Hand Soldering (Iron Condition)

Soldering Iron: 30W Max

Temperature 350°C Max

Soldering Time: 3 Seconds Max (One Time)

Distance: 1.6mm min (From Seating Plane)