

LT3753

Active Clamp Forward Converter with Synchronous Rectification

DESCRIPTION

Demonstration circuit 2050A is an active clamp forward converter with synchronous rectification featuring the [LT[®]3753](#).

This circuit was designed to demonstrate the high level of performance, efficiency, and small solution size attainable using this part. It operates at 250kHz and produces a regulated 5V, 20A output from an input voltage range of 36V to 72V: suitable for telecom, industrial, and other applications. It has an eighth-brick footprint area. Synchronous rectification helps to attain efficiency exceeding 94%.

The DC2050 circuit features soft-start which prevents output voltage overshoot during start-up or when recovering from an overload condition.

The DC2050 has a precise overcurrent protection circuit that allows for continuous operation and low power dissipation during short-circuit conditions which ensures high reliability.

Please refer to the LT3753 data sheet for design details and applications information.

Design files for this circuit board are available at <http://www.linear.com/demo>

LT, LT, LTC, LTM, Linear Technology and the Linear logo are registered trademarks of Linear Technology Corporation. All other trademarks are the property of their respective owners.

PERFORMANCE SUMMARY Specifications are at T_A = 25°C

SYMBOL	PARAMETER	CONDITIONS	MIN	TYP	MAX	UNITS
V _{IN}	Input Supply Range		36		72	V
V _{OUT}	Output Voltage		4.9	5.0	5.1	V
I _{OUT}	Output Current Range, Continuous		20			A
f _{SW}	Switching (Clock) Frequency			250		kHz
V _{OUT(P-P)}	Output Ripple	V _{IN} = 48V, I _{OUT} = 20A (20MHz BW)		50		mV _{P-P}
V _{REG}	Output Regulation	Line and Load (36V to 72V _{IN} , 0A to 20A _{OUT})		±0.1		%
P _{OUT} /P _{IN}	Efficiency (See Figure 2)	V _{IN} = 48V, I _{OUT} = 20A		94		%

QUICK START PROCEDURE

Note: When measuring the output voltage ripple, care must be taken to avoid a long ground lead on the oscilloscope probe. Measure the output voltage ripple by touching the probe tip and ground ring directly across the last output capacitor as shown in Figure 1.

1. Set an input power supply that is capable of 36V to 72V to 36V. Then turn off the supply.
2. With power off, connect the supply to the input terminals +VIN and –VIN.
 - a. Input voltages lower than 36V can keep the converter from turning on due to the undervoltage lockout feature of the LT3753.
 - b. If efficiency measurements are desired, an ammeter capable of measuring 5A DC can be put in series with the input supply in order to measure the DC2050A's input current.
 - c. A voltmeter with a capability of measuring at least 72V can be placed across the input terminals in order to get an accurate input voltage measurement.
3. Turn on the power at the input.

Note: Make sure that the input voltage does not exceed 100V.

4. Check for the proper output voltage of 5V. Turn off the power at the input.
5. Once the proper output voltages are established, connect a variable load capable of sinking 20A at 5V to the output terminals +VOUT and –VOUT. Set the current for 0A.
 - a. If efficiency measurements are desired, an ammeter or a resistor shunt that is capable of handling 20A DC can be put in series with the output load in order to measure the DC2050A's output current.
 - b. A voltmeter can be placed across the output terminals in order to get an accurate output voltage measurement.
6. Turn on the power at the input.

Note: If there is no output, temporarily disconnect the load to make sure that the load is not set too high.

7. Once the proper output voltage is again established, adjust the load within the operating range and observe the output voltage regulation, ripple voltage, efficiency and other desired parameters.

QUICK START PROCEDURE

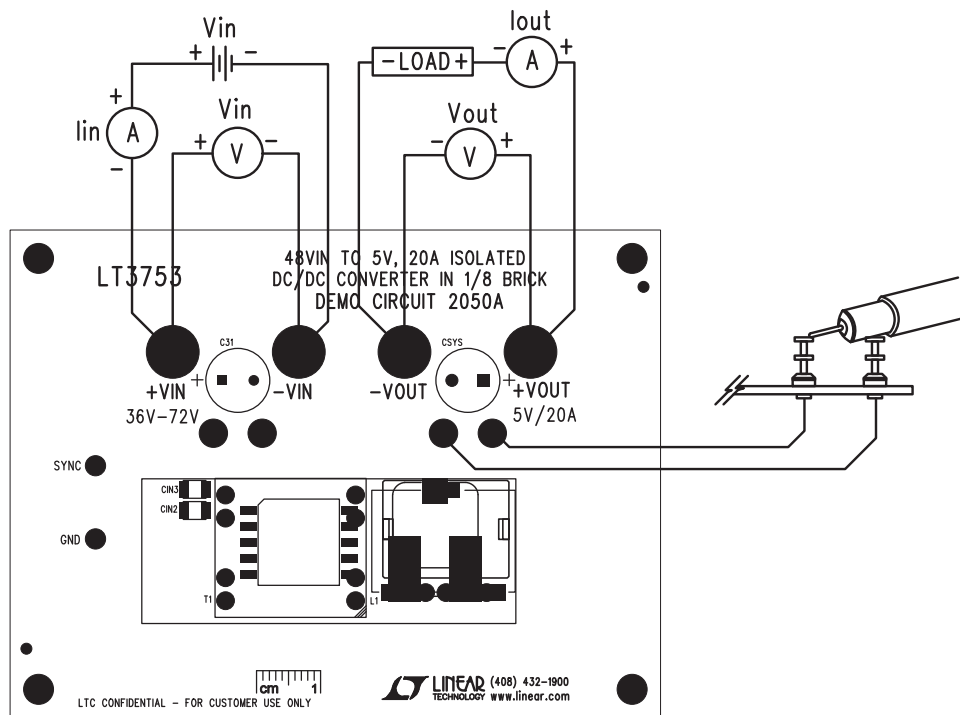

Figure 1. Proper Measurement Equipment Setup

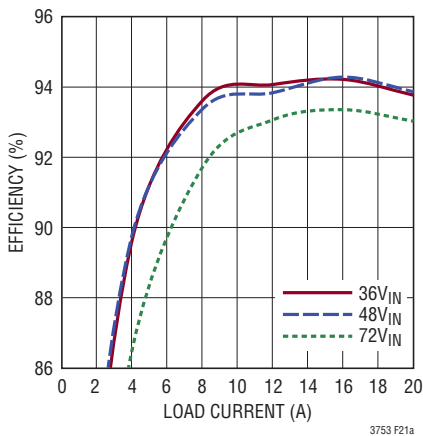

Figure 2. Efficiency vs Load Current

QUICK START PROCEDURE

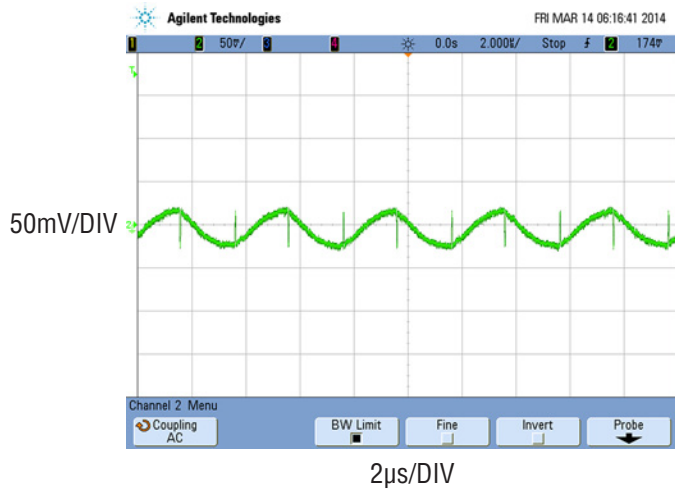

Figure 3. Output Ripple at 48V_{IN} and 20A_{OUT} (20MHz BW)

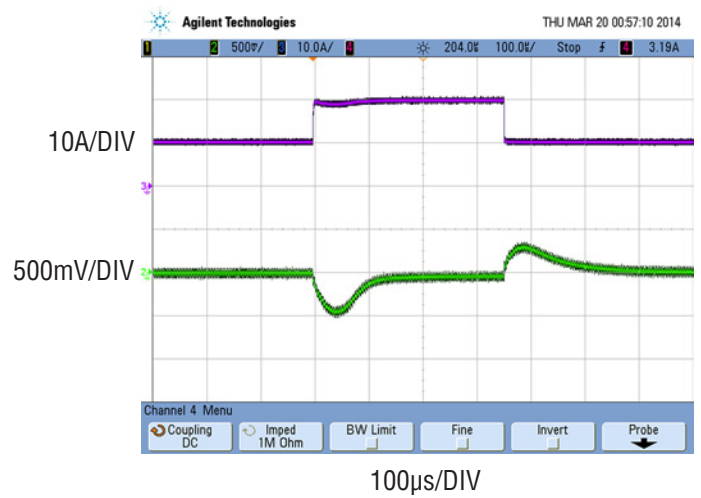

Figure 4. Transient Response Waveform at 48V_{IN} and 10A to 20A_{OUT}

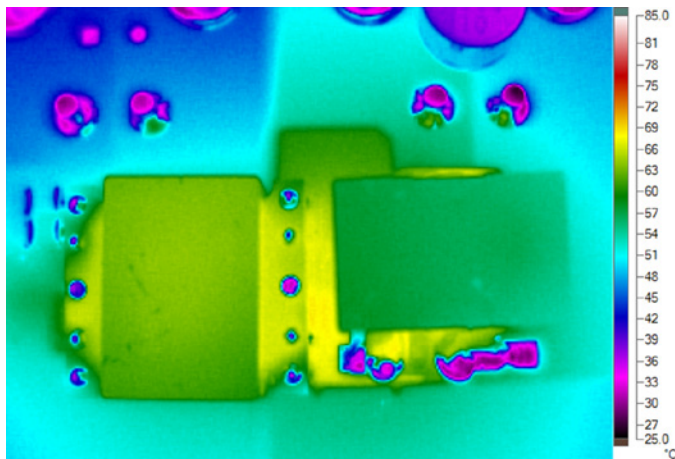

Figure 5. Thermal Map, Front Side at 48V_{IN} and 20A_{OUT} (T_A = 25°C)

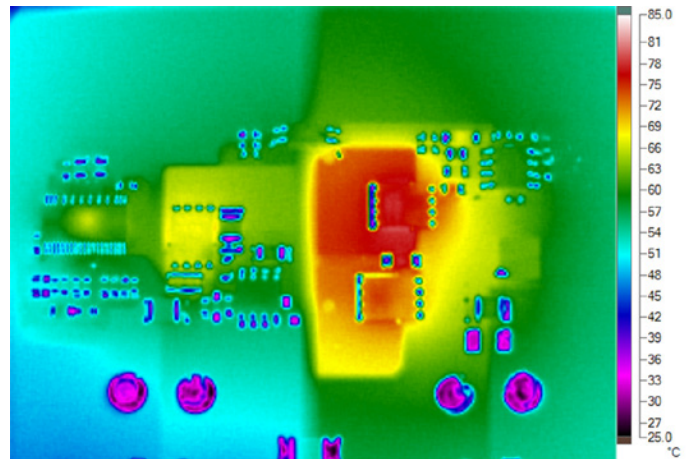

Figure 6. Thermal Map, Back Side at 48V_{IN} and 20A_{OUT} (T_A = 25°C)

PARTS LIST

ITEM	QTY	REFERENCE	PART DESCRIPTION	MANUFACTURER/PART NUMBER
Required Circuit Components				
1	3	CIN1, CIN2, CIN3	CAP., X7S, 4.7 μ F, 100V, 10% 1210	TDK, CGA6M3X7S2A475K
2	1	CO1	CAP., X7R, 47 μ F, 10V, 10% 1210	MURATA, GRM32ER71A476KE15L
3	1	CSYS	CAP., ALUM., 560 μ F, 10V,	PANASONIC., 10SEP560M
4	1	CY1	CAP., X7R, 2200pF, 250V, 10% 1812	MURATA, GA343QR7GD222KW01L
5	1	C2	CAP., X7R, 4.7 μ F, 25V, 10% 0805	MURATA, GRM21BR61E475KA12L
6	1	C3	CAP., X7R, 22nF, 25V, 10% 0603	MURATA, GRM188R71E223KA01D
7	1	C4	CAP., X7S, 1 μ F, 100V, 10% 0805	TDK, C2012X7S2A105K
8	1	C5	CAP., COG, 22pF, 50V, 5% 0603	MURATA, GRM1885C1H220JA01D
9	1	C12	CAP., X7R, 0.1 μ F, 50V, 10% 0603	MURATA, GRM188R71H104KA93D
10	3	C1, C13, C20	CAP., X7R, 1 μ F, 25V, 10% 0603	MURATA, GRM188R71E105KA12D
11	1	C14	CAP., X7R, 68nF, 250V, 10% 1206	MURATA, GRM31BR72E683KW03L
12	1	C15	CAP., X7R, 0.22 μ F, 250V, 10% 1210	MURATA, GRM32DR72E224KW01L
13	1	C18	CAP., COG, 4.7nF, 50V, 5% 0603	MURATA, GRM1885C1H472JA01D
14	1	C21	CAP., COG, 3.3nF, 50V, 5% 0603	MURATA, GRM1885C1H332JA01D
15	1	C22	CAP., X5R, 22 μ F, 10V, 10% 0805	TDK, C2012X5R1A226K
16	1	D4	ZENER DIODE, 4.3V, SOD-123	DIODES., BZT52C4V3-7-F
17	1	D5	DIODE, HIGH SPEED DIODE, SOD-523	NXP/PHILLIPS SEMI., BAS516
18	1	L1	INDUCTOR, 3.3 μ H	CHAMPS, PQI2050-3R3
19	1	Q1	N-MOSFET POWER-56	INFINEON, BSC190N15NS3 G
20	1	Q2	SMPS MOSFET S08	IR, IRF6217
21	2	Q3, Q4	POWER MOSFET, PG-TDSON-8	INFINEON, BSC0902NSI
22	1	RCS1	RES., CHIP, 0.012 Ω , 1W, 1%, 0815	SUSUMU, RL3720WT-R12-F
23	1	R1	RES., Chip, 30.1k, 0.1W, 1% 0603	VISHAY, CRCW060330K1FKEA
24	1	R2	RES., Chip, 14.7k, 0.1W, 1% 0603	VISHAY, CRCW060314K7FKEA
25	1	R5	RES., Chip, 44.2k, 0.1W, 1% 0603	VISHAY, CRCW060344K2FKEA
26	1	R6	RES., Chip, 57.6k, 0.1W, 1% 0603	VISHAY, CRCW060357K6FKEA
27	1	R7	RES., Chip, 1.87k, 0.1W, 1% 0603	VISHAY, CRCW06031K87FKEA
28	1	R8	RES., Chip, 1.96k, 0.1W, 1% 0603	VISHAY, CRCW06031K96FKEA
29	1	R9	RES., Chip, 105k, 0.125W, 1% 0805	YAGEO, RC0805FR-07105KL
30	3	R15, R21, R24	RES., Chip, 1.0k, 0.1W, 5% 0603	VISHAY, CRCW06031K00JNEA

DEMO MANUAL DC2050A

PARTS LIST

ITEM	QTY	REFERENCE	PART DESCRIPTION	MANUFACTURER/PART NUMBER
31	1	R16	RES., Chip, 34.8k, 0.1W, 1% 0603	VISHAY, CRCW060334K8FKEA
32	1	R17	RES., Chip, 15 Ω , 0.1W, 5% 0603	VISHAY, CRCW060315R0JNEA
33	2	R18, R19	RES., Chip, 100k, 0.1W, 5% 0603	VISHAY, CRCW0603100KJNEA
34	2	R20, R28	RES., Chip, 137k, 0.25W, 1% 0603	VISHAY, CRCW0603137KFKEA
35	1	R23	RES., Chip, 100 Ω , 0.1W, 5% 0603	VISHAY, CRCW0603100RJNEA
36	1	R25	RES., Chip, 10k, 0.1W, 5% 0603	VISHAY, CRCW060310K0JNEA
37	1	R26	RES., Chip, 200 Ω , 0.125W, 1% 0805	YAGEO, RC0805FR-07200R
38	1	R29	RES., Chip, 100 Ω , 0.125W, 1% 0805	VISHAY, CRCW0805100RFKEA
39	1	R32	RES., Chip, 5.1 Ω , 0.125W, 5% 1206	VISHAY, CRCW12065R10JNEA
40	1	R33	RES., Chip, 5.1 Ω , 0.125W, 5% 0805	VISHAY, CRCW08055R10JNEA
41	1	T1	TRANSFORMER,	CHAMPS, G45R2-0209
42	1	U1	I.C., LT3753EFE#TRPBF, TSSOP-38(31)	LINEAR TECH., LT3753EFE#TRPBF
43	1	U2	I.C., PS2801C-1-P-A	NEC, PS2801C-1-P-A
44	1	U3	I.C., LT1431CS8 S08	LINEAR TECH., LT1431CS8#TRPBF

Additional Demo Board Circuit Components

1	0	CO2 (OPT)	CAP., 1210	
2	0	C31 (OPT)	CAP.,	
3	0	R10 (OPT)	RES., 0603	

Hardware-For Demo Board Only

1	2	E1, E2	TESTPOINT, TURRET, 0.061" PBF	MILL-MAX, 2308-2-00-80-00-00-07-0
2	4	E3, E4, E5, E6	TESTPOINT, TURRET, 0.094" PBF	MILL-MAX, 2501-2-00-80-00-00-07-0
3	4	J1-J4	BANANA JACK	KEYSTONE, 575-4
4	4	MH1-MH4	STAND-OFF, NYLON 0.25"	KEYSTONE, 8831(SNAP ON)
5	1		FAB, PRINTED CIRCUIT BOARD	DEMO CIRCUIT 2050A

SCHEMATIC DIAGRAM

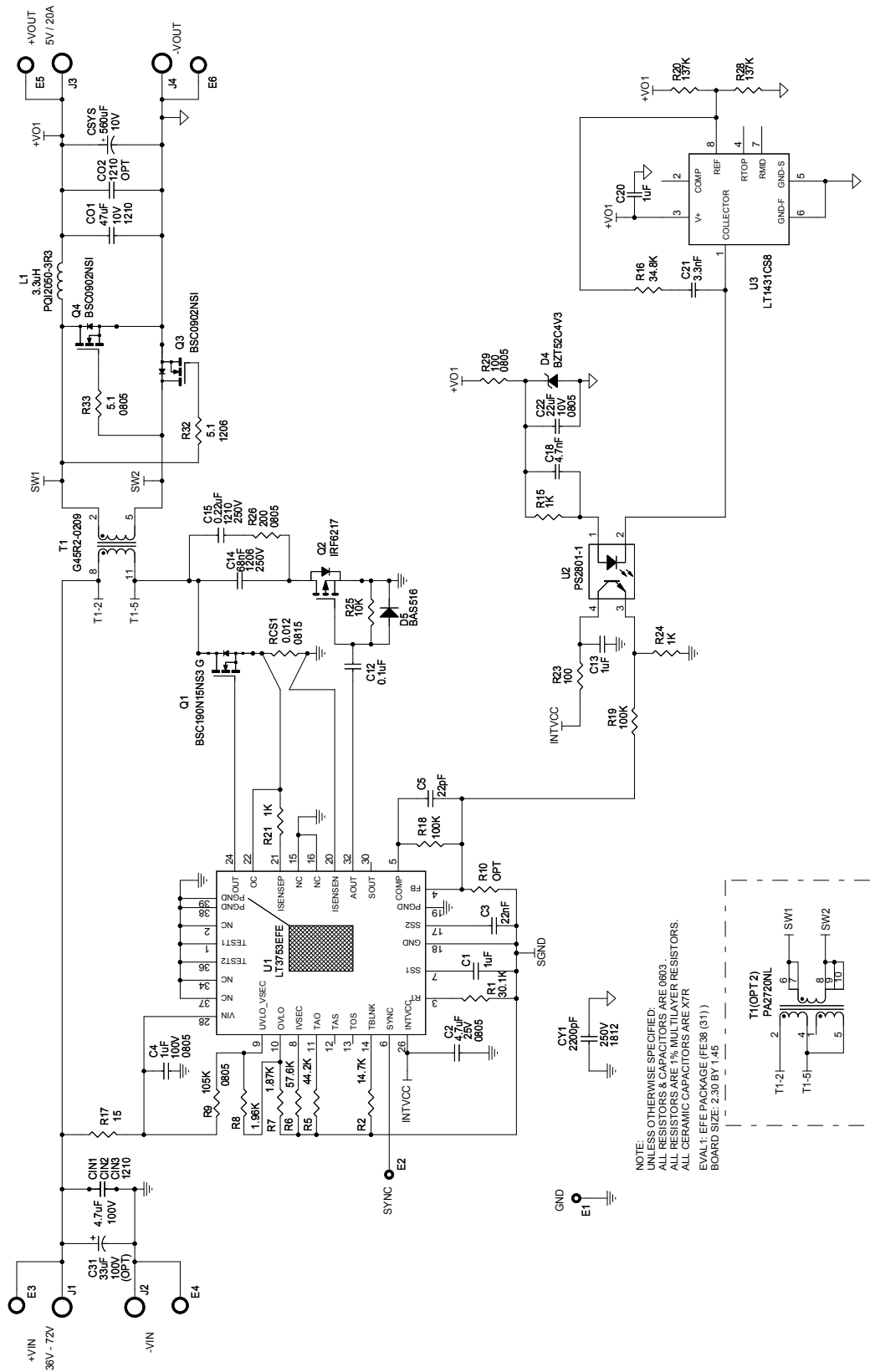

DEMO MANUAL DC2050A

DEMONSTRATION BOARD IMPORTANT NOTICE

Linear Technology Corporation (LTC) provides the enclosed product(s) under the following **AS IS** conditions:

This demonstration board (DEMO BOARD) kit being sold or provided by Linear Technology is intended for use for **ENGINEERING DEVELOPMENT OR EVALUATION PURPOSES ONLY** and is not provided by LTC for commercial use. As such, the DEMO BOARD herein may not be complete in terms of required design-, marketing-, and/or manufacturing-related protective considerations, including but not limited to product safety measures typically found in finished commercial goods. As a prototype, this product does not fall within the scope of the European Union directive on electromagnetic compatibility and therefore may or may not meet the technical requirements of the directive, or other regulations.

If this evaluation kit does not meet the specifications recited in the DEMO BOARD manual the kit may be returned within 30 days from the date of delivery for a full refund. **THE FOREGOING WARRANTY IS THE EXCLUSIVE WARRANTY MADE BY THE SELLER TO BUYER AND IS IN LIEU OF ALL OTHER WARRANTIES, EXPRESSED, IMPLIED, OR STATUTORY, INCLUDING ANY WARRANTY OF MERCHANTABILITY OR FITNESS FOR ANY PARTICULAR PURPOSE. EXCEPT TO THE EXTENT OF THIS INDEMNITY, NEITHER PARTY SHALL BE LIABLE TO THE OTHER FOR ANY INDIRECT, SPECIAL, INCIDENTAL, OR CONSEQUENTIAL DAMAGES.**

The user assumes all responsibility and liability for proper and safe handling of the goods. Further, the user releases LTC from all claims arising from the handling or use of the goods. Due to the open construction of the product, it is the user's responsibility to take any and all appropriate precautions with regard to electrostatic discharge. Also be aware that the products herein may not be regulatory compliant or agency certified (FCC, UL, CE, etc.).

No License is granted under any patent right or other intellectual property whatsoever. **LTC assumes no liability for applications assistance, customer product design, software performance, or infringement of patents or any other intellectual property rights of any kind.**

LTC currently services a variety of customers for products around the world, and therefore this transaction **is not exclusive**.

Please read the DEMO BOARD manual prior to handling the product. Persons handling this product must have electronics training and observe good laboratory practice standards. **Common sense is encouraged.**

This notice contains important safety information about temperatures and voltages. For further safety concerns, please contact a LTC application engineer.

Mailing Address:

Linear Technology
1630 McCarthy Blvd.
Milpitas, CA 95035

Copyright © 2004, Linear Technology Corporation